



TnT speeltoestellen

Montagehandleiding

3do-1479



Toestel	3do-1479
Datum montagehandleiding	21-05-2026

Beste klant van TnT Speeltoestellen,

Wij danken u voor het aanschaffen en installeren van een speeltoestel van TnT Speeltoestellen.
Wij waarderen het vertrouwen dat u in ons bedrijf heeft geplaatst en streven ernaar om uw vertrouwen meer dan waar te maken!

Dit is uw TnT speeltoestellen montagehandleiding.

Wij hebben deze handleiding specifiek voor het product ontworpen, waarop eveneens de toe te passen onderdelen zijn genoemd.

Ook vindt u het grondplan met de benodigde valruimte volgens norm NEN-EN1176-1 : 2017.

Bewaart u dit document bij uw logboek. Nogmaals willen wij u bedanken voor de aankoop van dit speeltoestel. Wij zien uit naar uw volgende speelproject.

Met vriendelijke groet, TnT Speeltoestellen

Inhoudsopgave

Aanzichten 3D	2
Onderdelenlijst	4
Veiligheidsruimtes	6
Zijaanzichten	7
Plattegrond palenplan	9
Paalmaten	10
Paaldata	11
Onderdeel handleidingen	13
Staander 290cm	14
Staander 390cm	16
Staander 350cm	18
Zeskant vloer (vloer_zeshoek_volledig)	20
Vloer driehoek (vloer_driehoek)	22
Tussentrap met railing 60cm (trap_60cm_tussen)	24
Paneel raam (paneel_raam)	28
Paneel getallen (paneel_getallen)	30
Paneel tandwielen (paneel_tandwielen)	32
Standaard trap (opgang_trap)	34
Klimrek recht (klimrek_recht_90cm_120cm_breed)	38
Klimrek gebogen (klimrek_gebogen_150cm)	42
Opgang stangen (opgang_stangen_90cm)	46
Glijstang (glijstang_150cm)	52
Opgang doppen (opgang_doppen_90cm)	56
Slangen opgang (klimrek_slang_150cm)	60
Glijstang (glijstang_150cm_breed)	64
Glijbaan tunnel recht (glijbaan_150cm_rechte_tunnel)	68
Hexagon blader dak (dak_hexagon_bladeren)	86
Bankje (bankje)	90
Tafeltje (tafeltje_vloer_zeshoek)	92

Aanzichten 3D



Aanzicht 1



Aanzicht 2

Aanzichten 3D











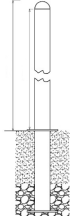
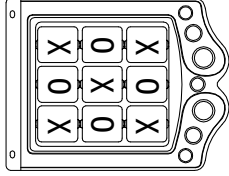
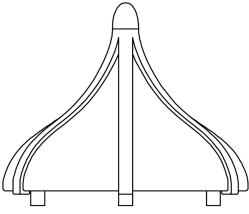
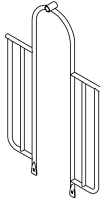

Aanzicht 3

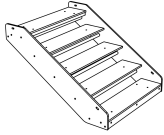

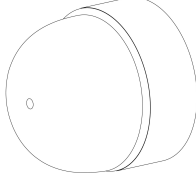

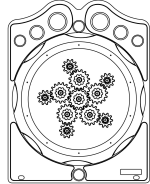
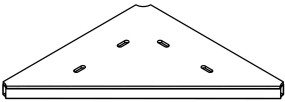
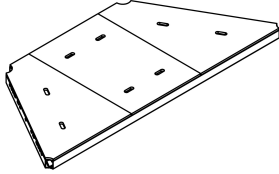
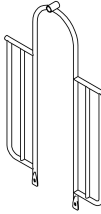

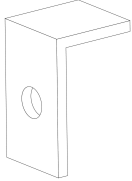
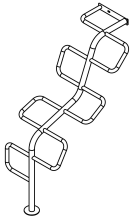
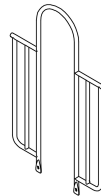
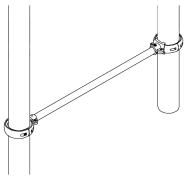

Aanzicht 4

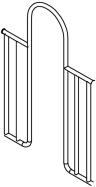
Onderdelenlijst

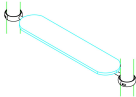
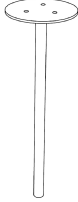
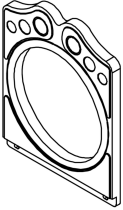
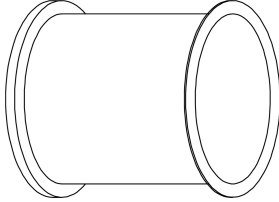
<p>6x Staander 390cm 390x11,5cm</p> 	<p>1x Staander 350cm 350x11,5cm</p> 	<p>7x Staander 290cm 290x11,5cm</p> 	<p>1x XO paneel kunststof (tussen palen) 12100x10100x2000cm</p> 
<p>1x Zeskant dak met panelen 290x290x120cm</p> 	<p>1x Hekje tbv: B, Pod en Curly Climber 152x101cm</p> 	<p>1x 90cm Pod climber 304x71cm</p> 	<p>1x 60cm tussentrap HPL 117x97x75cm</p> 
<p>1x 60cm tussentrap railing HPL (per 2stuks) 166x116,5cm</p> 	<p>30x Afdekdop M10 M10</p> 	<p>1x Ruit paneel kunststof 123x96x13cm</p> 	<p>1x Tandwielen paneel kunststof 121x101x11cm</p> 
<p>2x Vloer driehoek HPL 113x165x8,5cm</p> 	<p>4x Halve zeskant vloer HPL (4 staanders) 227x101x8,5cm</p> 	<p>1x Hekje tbv glijstang 152x101cm</p> 	<p>2x 150cm Glijstang 362x42cm</p> 
<p>2x Hoekje</p> 	<p>1x 150cm Snake climber 209x67cm</p> 	<p>1x Hekje zonder bevestiging (boven) 152x101cm</p> 	<p>1x Stangenopgang 90cm 3,2x101 (stang 1x)</p> 

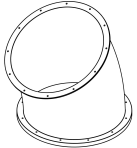
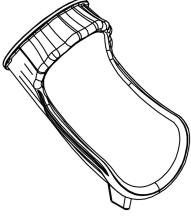
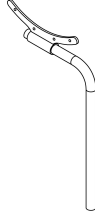
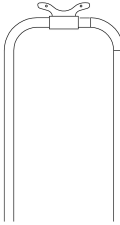
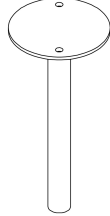
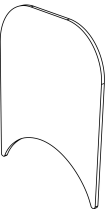
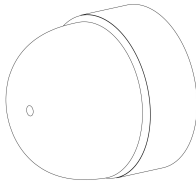
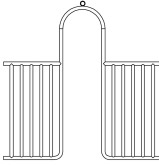
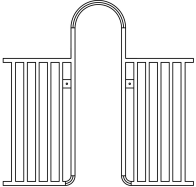
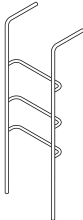
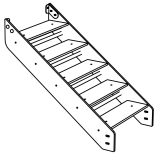
Onderdelenlijst (vervolgd)

<p>2x Hekje tbv Snake climber 138x101cm</p>	<p>1x 150cm Curve climber 206x104x46cm</p>	<p>4x Bankje 2.0 116x22x4cm</p>	<p>1x Tafel PE toestel 40x122cm</p>
			
<p>1x Kruipbuis paneel 121x94cm</p>	<p>2x Tube glijbaan 60cm deel recht Ø85x60 cm</p>	<p>1x Tube glijbaan 60cm deel recht (transparant) Ø85x60 cm</p>	<p>1x Tube glijbaan 30 graden bocht 106x103x90 cm</p>
			
<p>1x Tube glijbaan exit 165x106x92 cm</p>	<p>1x Tube glijbaanvoet 131cm 205x89x18cm</p>	<p>1x Dubbele voet tube glijbaan 110x70x5 cm</p>	<p>1x Tubeglijbaanvoet voorkant 30x15cm</p>
			
<p>1x PE Plaat tubeglijbaan 93x77x2cm</p>	<p>101x Afdekdop M8 M8</p>	<p>1x Hek Driehoeksvloer met bevestiging 157x156cm</p>	<p>1x Hek Driehoeksvloer voor verticale opgang 145x156cm</p>
			
<p>1x 90cm Vertical Climber 230x55x45cm</p>	<p>1x 90cm trap HPL 101x64x19cm</p>	<p>1x 90cm trapleuningen HPL (2 stuks) 248x103x18cm</p>	
			

Veiligheidsruimtes

Geachte klant,

Zorg er altijd voor dat alle veiligheidsruimtes zoals aangegeven in ieder geval gehaald worden, dit zijn de minimale vereiste ruimtes voor een veilig gebruik van het speeltoestel.

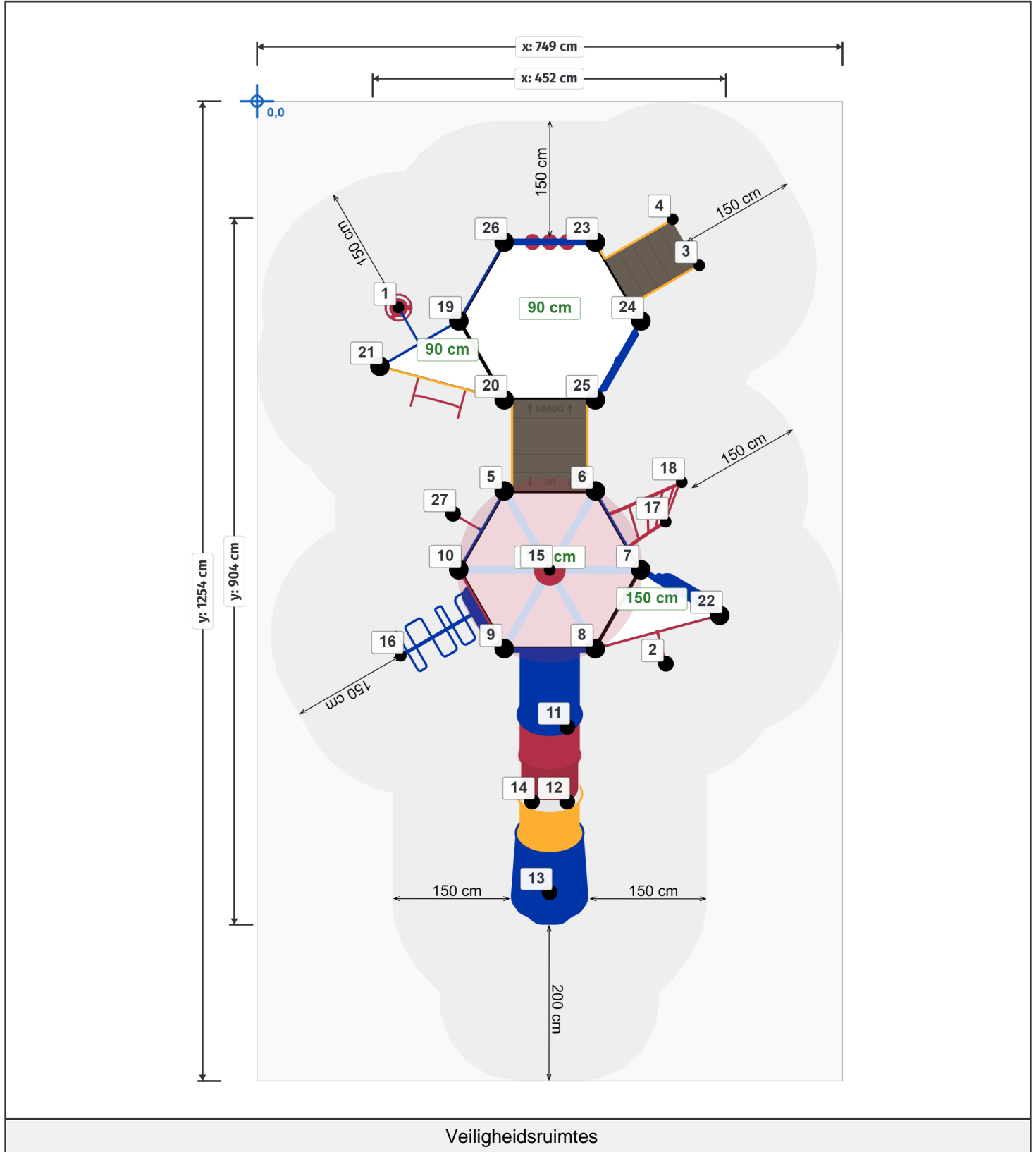

Zijaanzichten

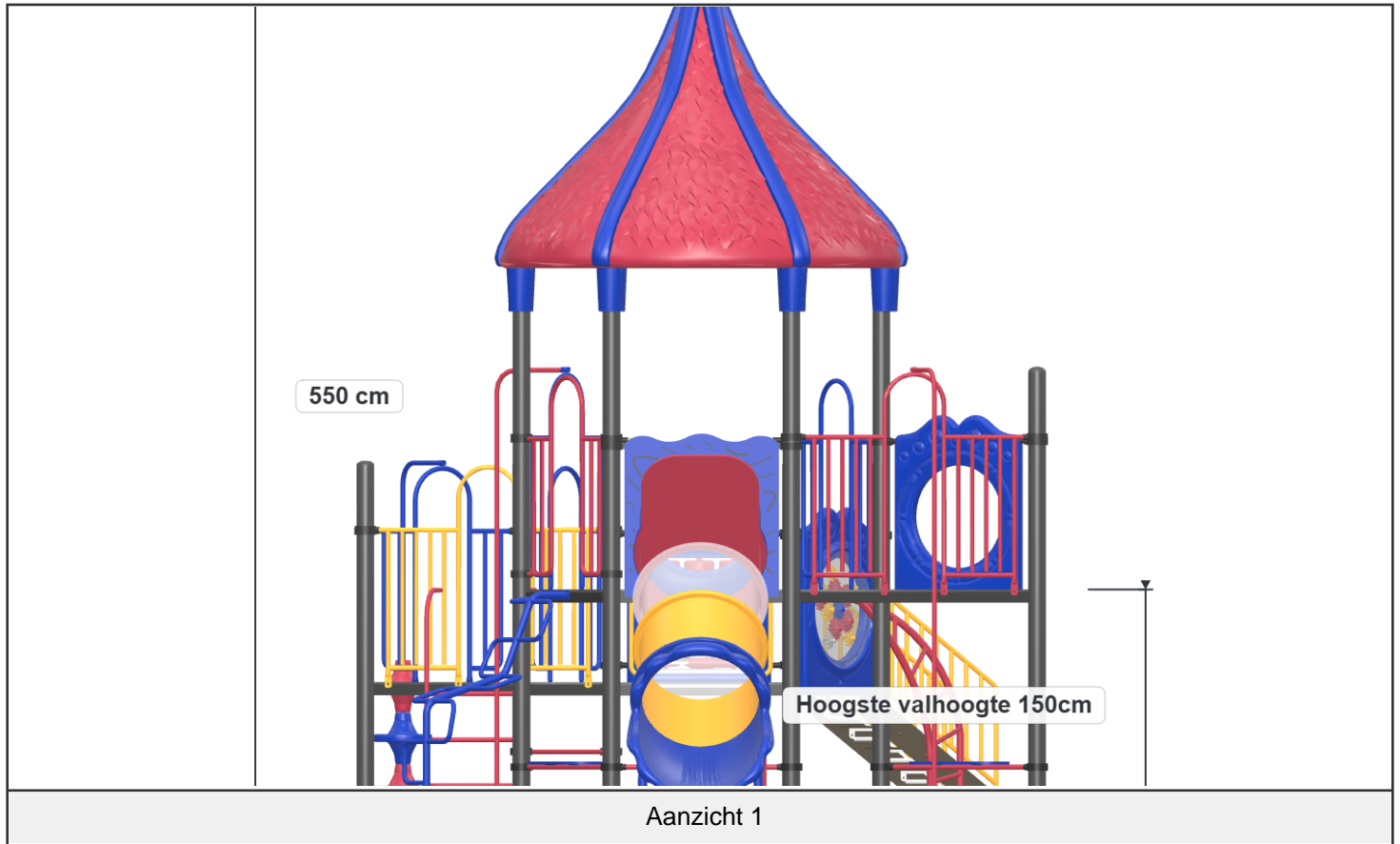

Zijaanzichten



Aanzicht 3



Aanzicht 4

Plattegrond palenplan

U kunt van deze tekening niet afmeten!

Voor de betonfundatie heeft u 37,5 kg snelbeton per staander nodig.

Voor de overige onderdelen (Glijstangen, Climbers, Glijbaan voeten) 25 kg snelbeton.

Houdt u er rekening mee dat de betonfundatie minimaal 400mm onder het maaiveld blijft, zoals op de tekening afgebeeld.

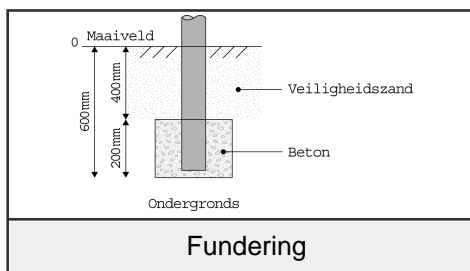
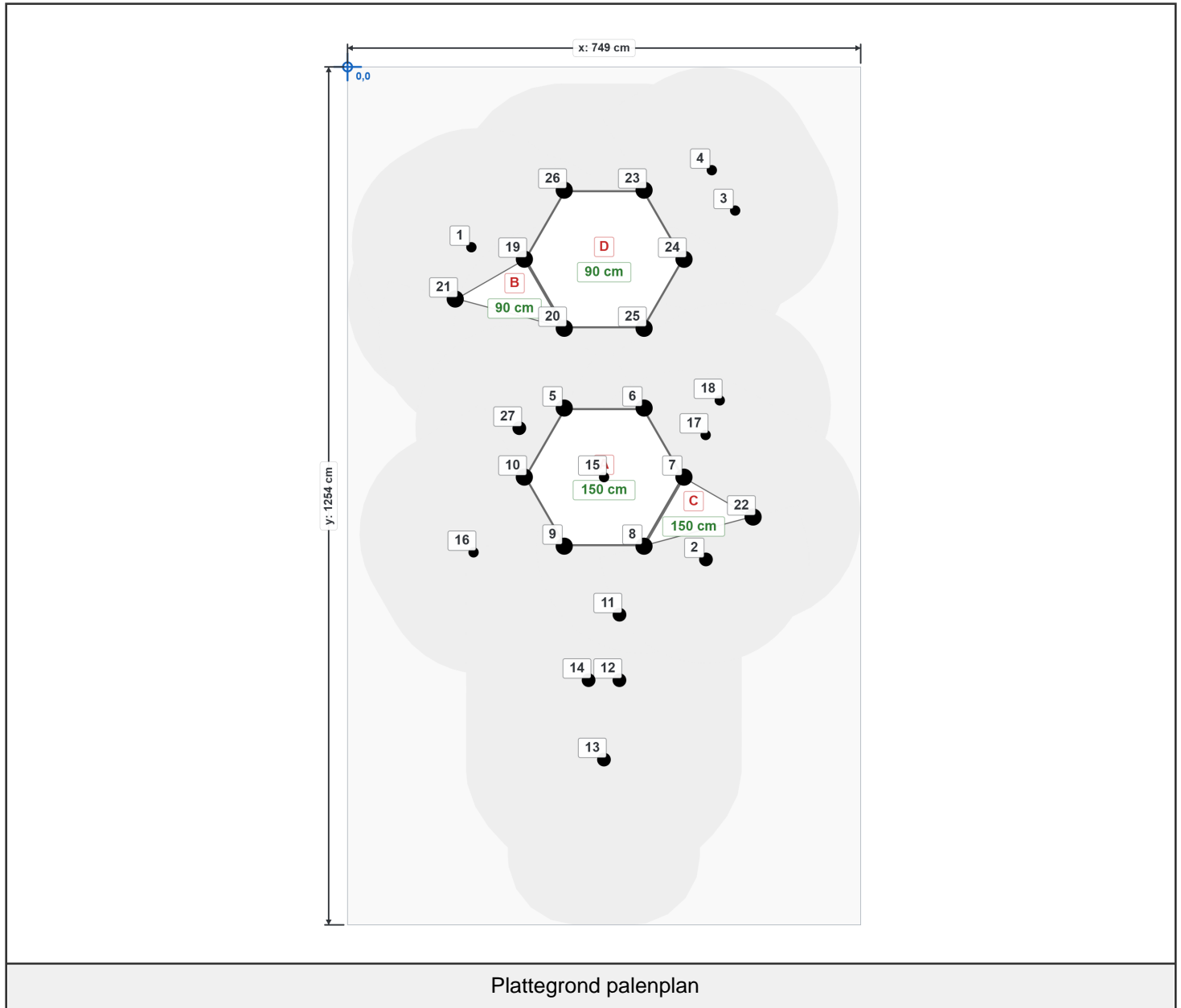

Paalmaten

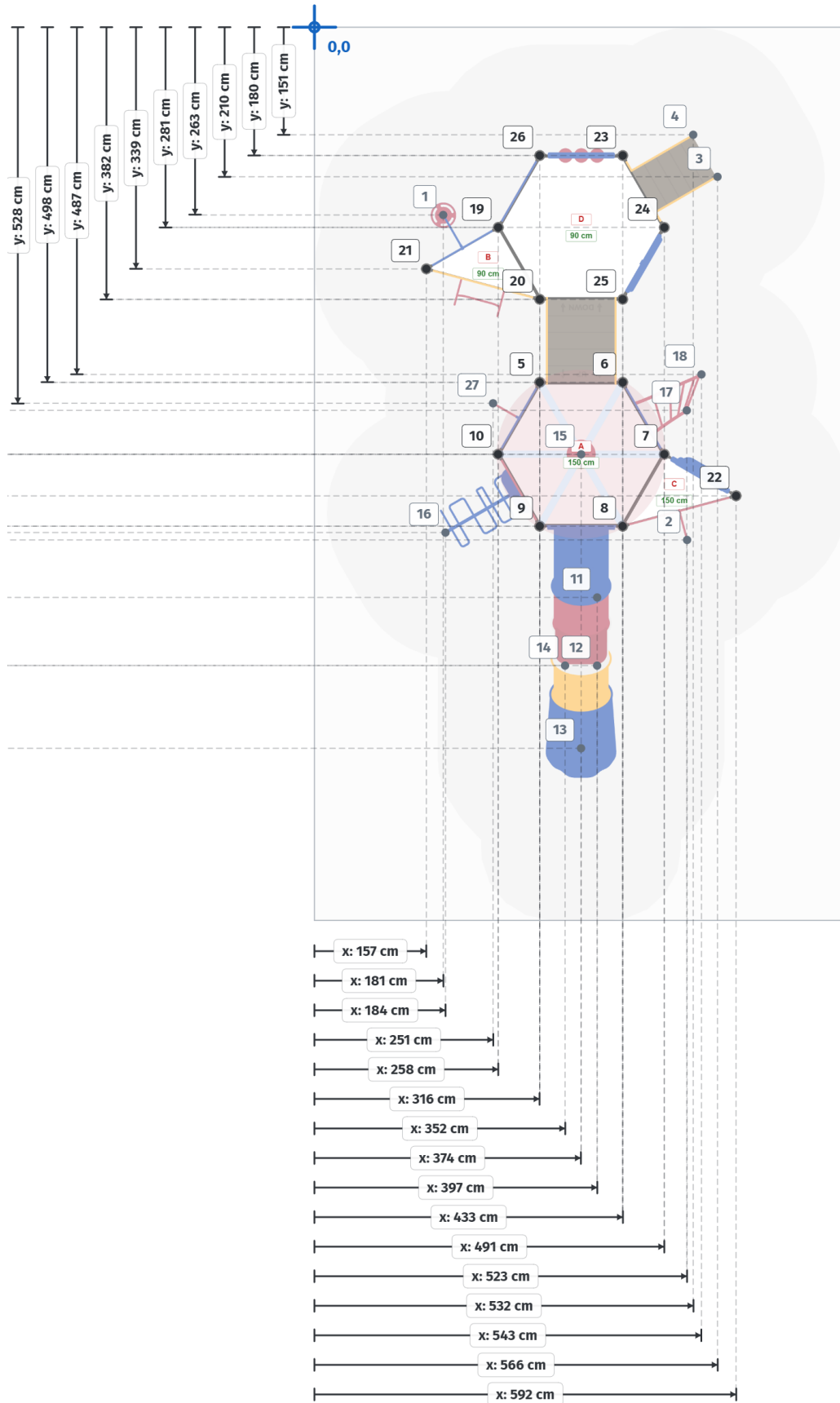

Paaldata

Staanders			
Label	X	Y	Hoogte
1	181 cm	264 cm	0 cm
2	524 cm	720 cm	0 cm
3	566 cm	210 cm	0 cm
4	532 cm	151 cm	0 cm
5	317 cm	499 cm	390 cm
6	433 cm	499 cm	390 cm
7	491 cm	600 cm	390 cm
8	433 cm	701 cm	390 cm
9	317 cm	701 cm	390 cm
10	258 cm	600 cm	390 cm
11	397 cm	801 cm	0 cm
12	397 cm	896 cm	0 cm
13	375 cm	1012 cm	0 cm
14	352 cm	896 cm	0 cm
15	375 cm	600 cm	0 cm
16	184 cm	710 cm	0 cm
17	523 cm	538 cm	0 cm
18	544 cm	488 cm	0 cm
19	258 cm	281 cm	290 cm
20	317 cm	382 cm	290 cm
21	158 cm	340 cm	290 cm
22	592 cm	658 cm	350 cm
23	433 cm	181 cm	290 cm
24	492 cm	281 cm	290 cm
25	433 cm	382 cm	290 cm
26	317 cm	181 cm	290 cm
27	251 cm	528 cm	0 cm

Paaldata (vervolgd)

Vloeren	
Label	Hoogte
A	150 cm
B	90 cm
C	150 cm
D	90 cm

Onderdeel handleidingen

Op de volgende pagina's van dit document vindt u alle individuele onderdelen met bijbehorende technische tekeningen en eventuele montage instructies.

Staander 290cm

Hoofdafmetingen: 290x11,5cm

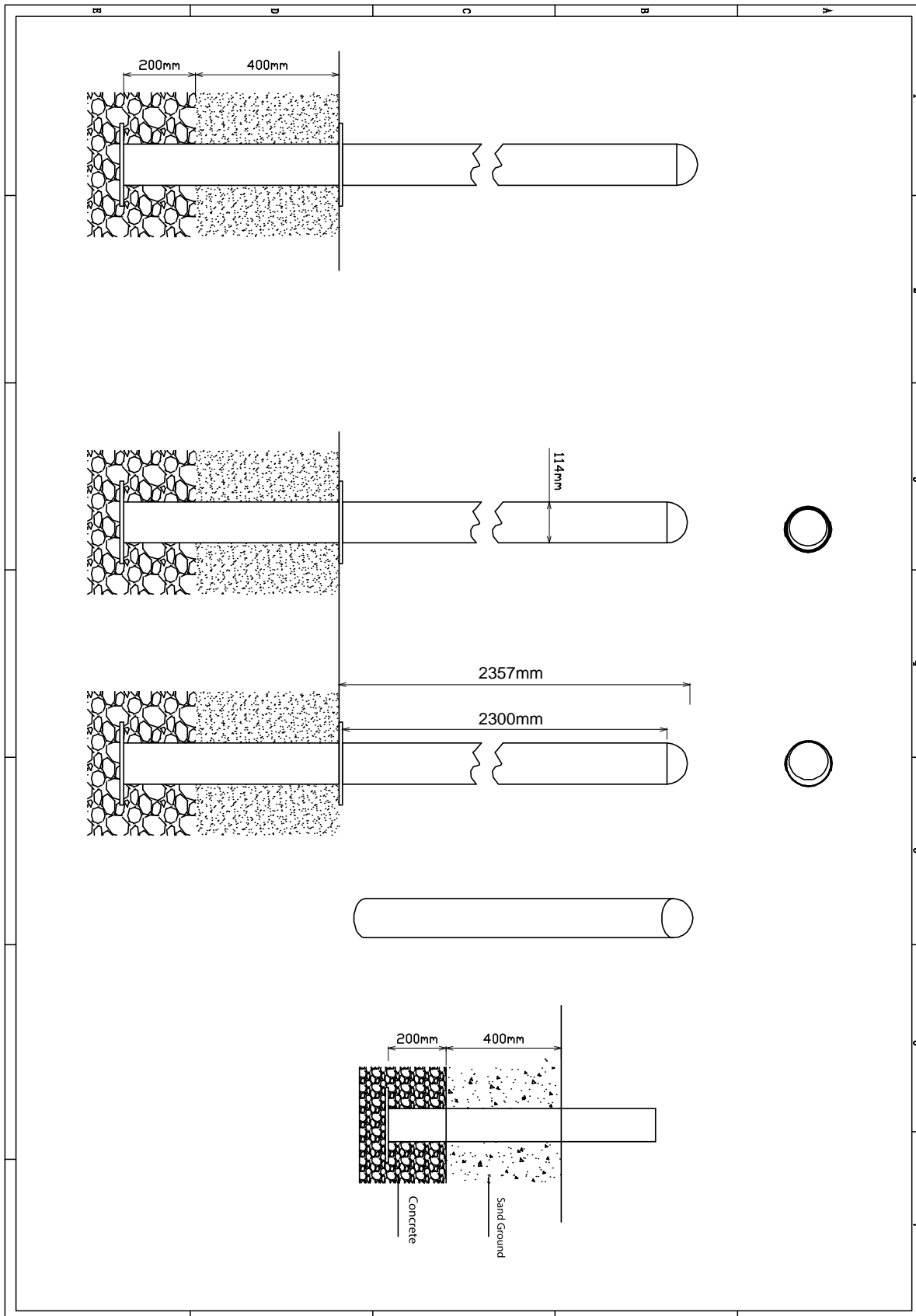



Staander

STAP 1 van 1

Omschrijving: Paalkap losdraaien en opnieuw bevestigen met loctite op het draadeind

1 st. Loctite

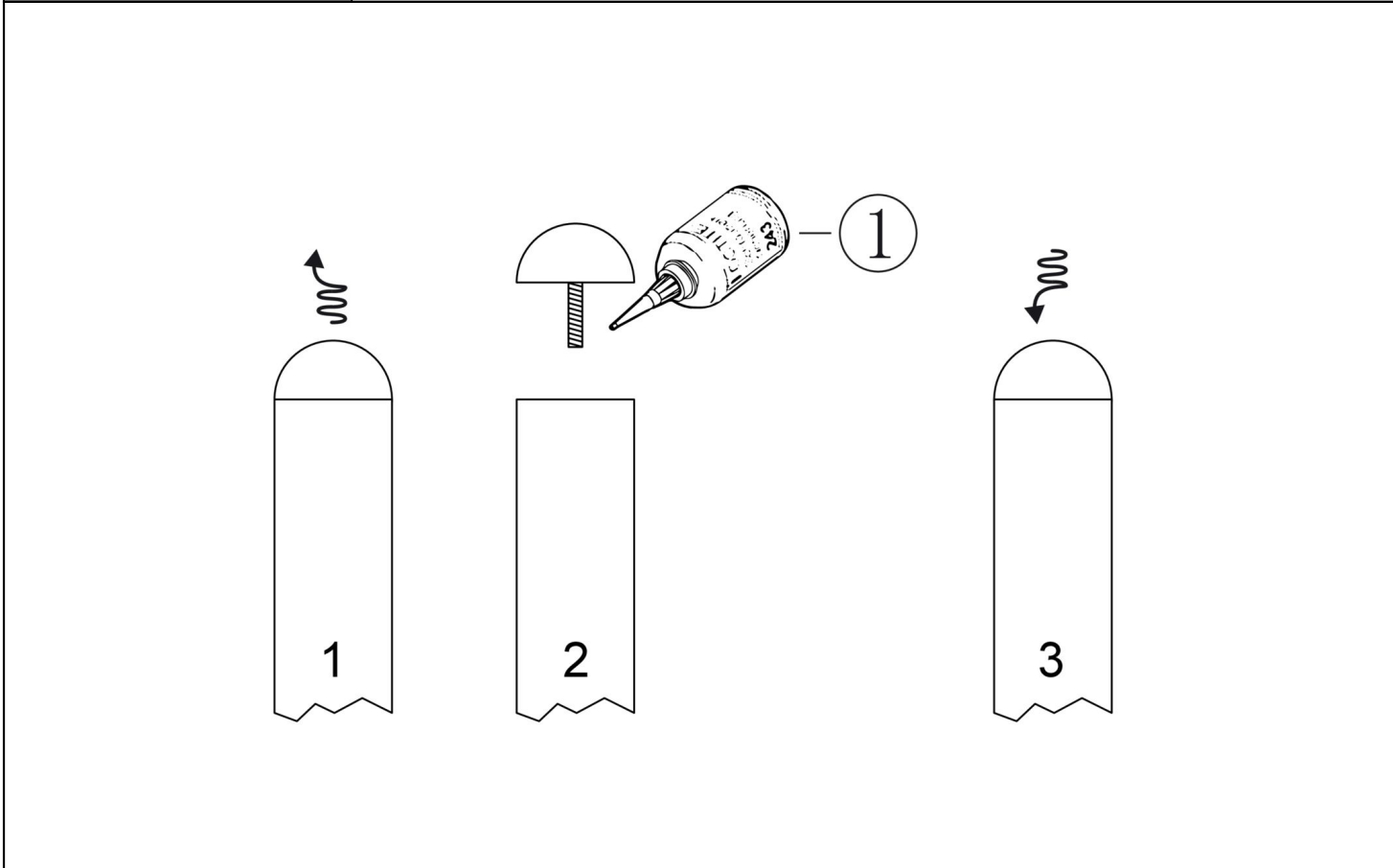
1



Bevestigings materiaal is per zakje verpakt en bovenstaande afbeelding zit in het zakje

Staander 390cm

Hoofdafmetingen: 390x11,5cm

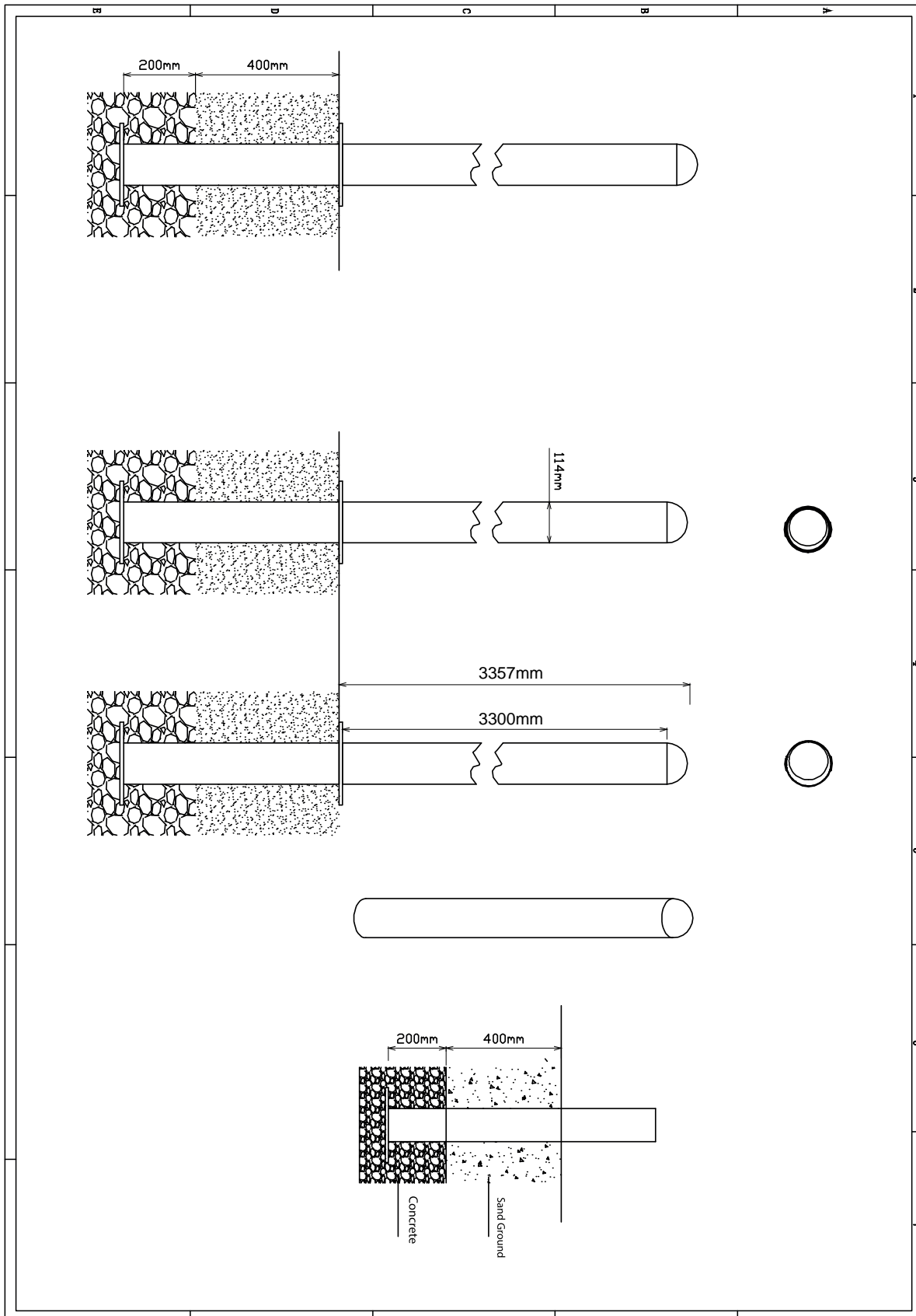



Staander

STAP 1 van 1

Omschrijving: Paalkap losdraaien en opnieuw bevestigen met loctite op het draadeind

1 st. Loctite

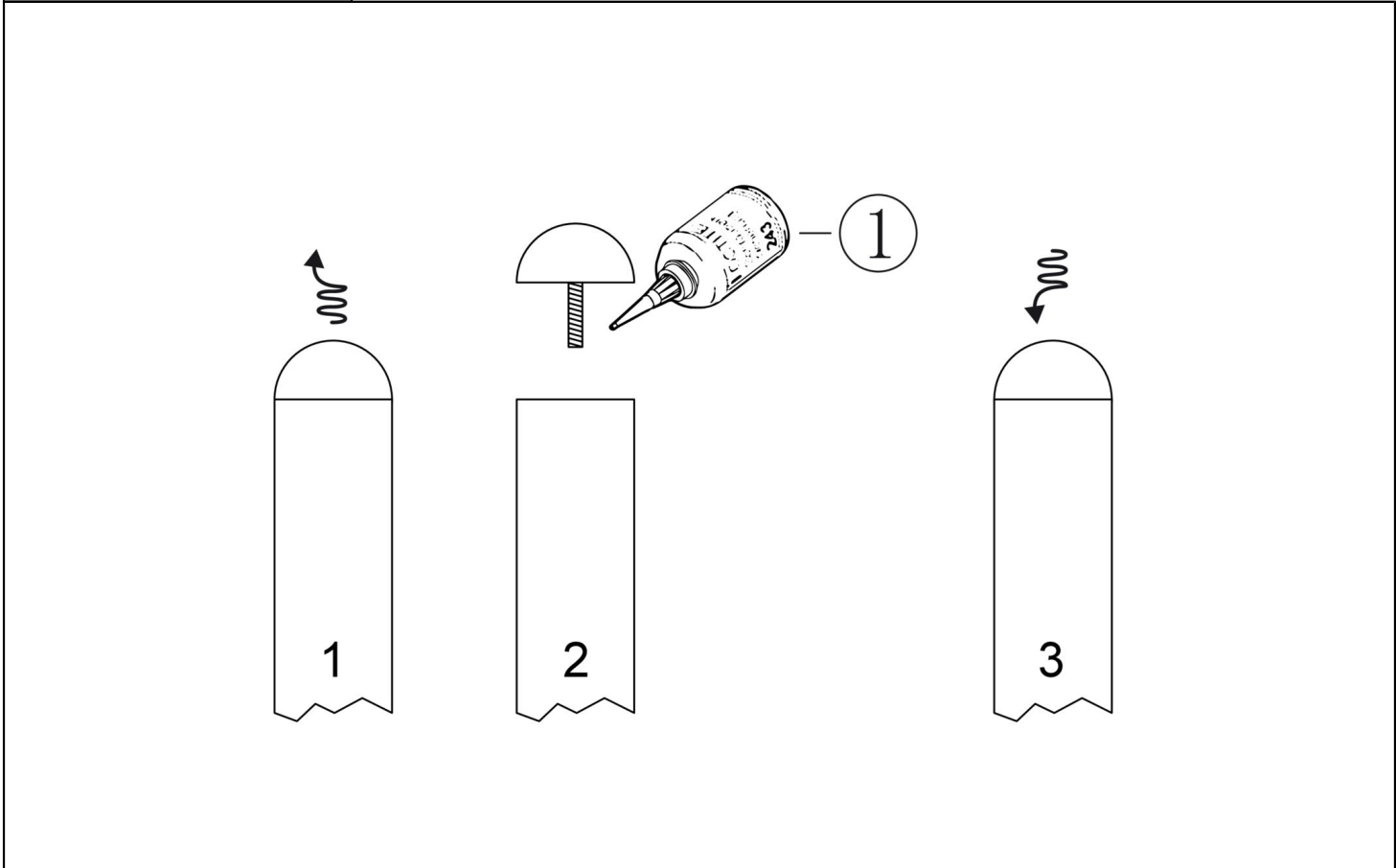
1



Bevestigings materiaal is per zakje verpakt en bovenstaande afbeelding zit in het zakje

Staander 350cm

Hoofdafmetingen: 350x11,5cm

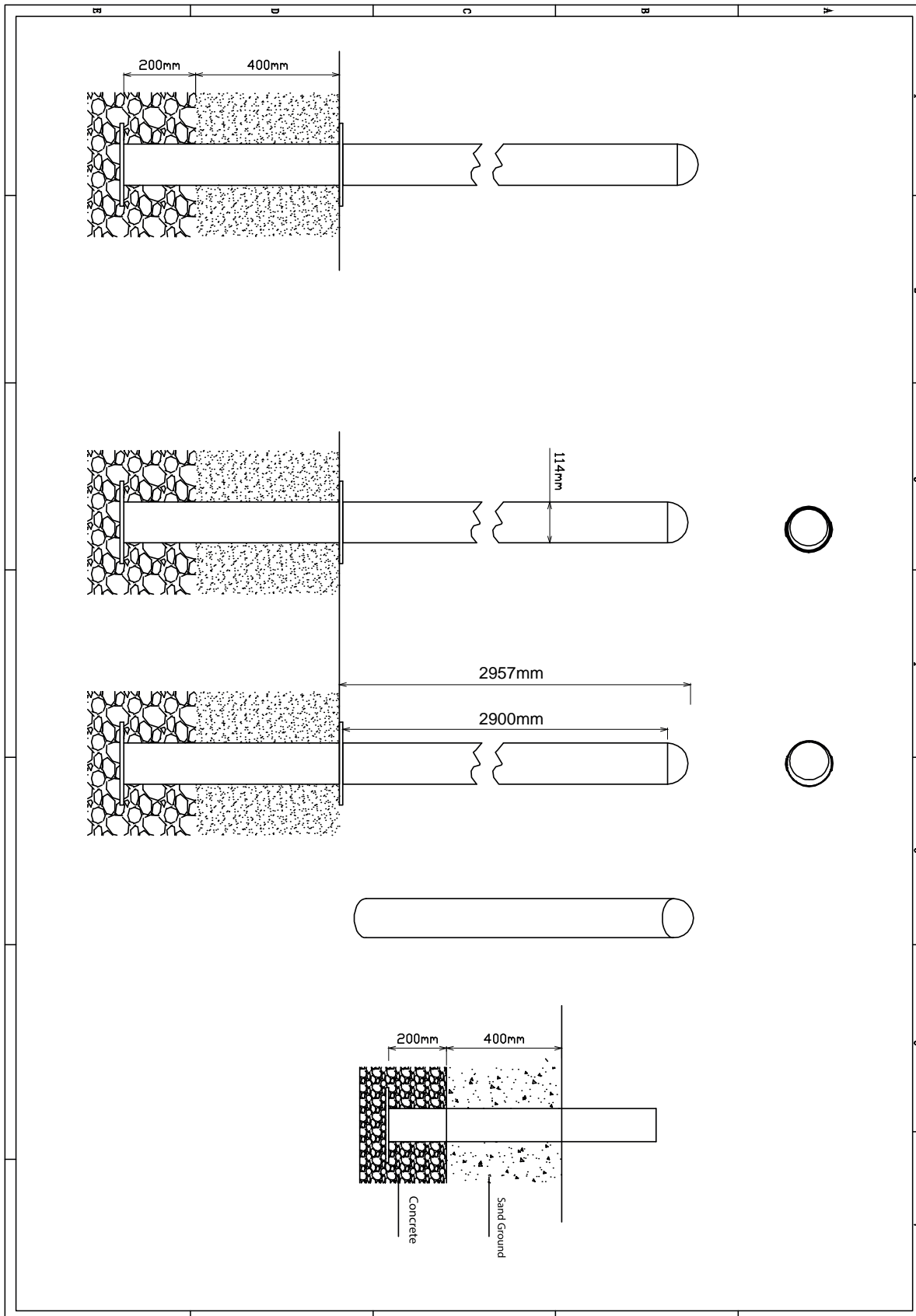



Staander

STAP 1 van 1

Omschrijving: Paalkap losdraaien en opnieuw bevestigen met loctite op het draadeind

1 st. Loctite

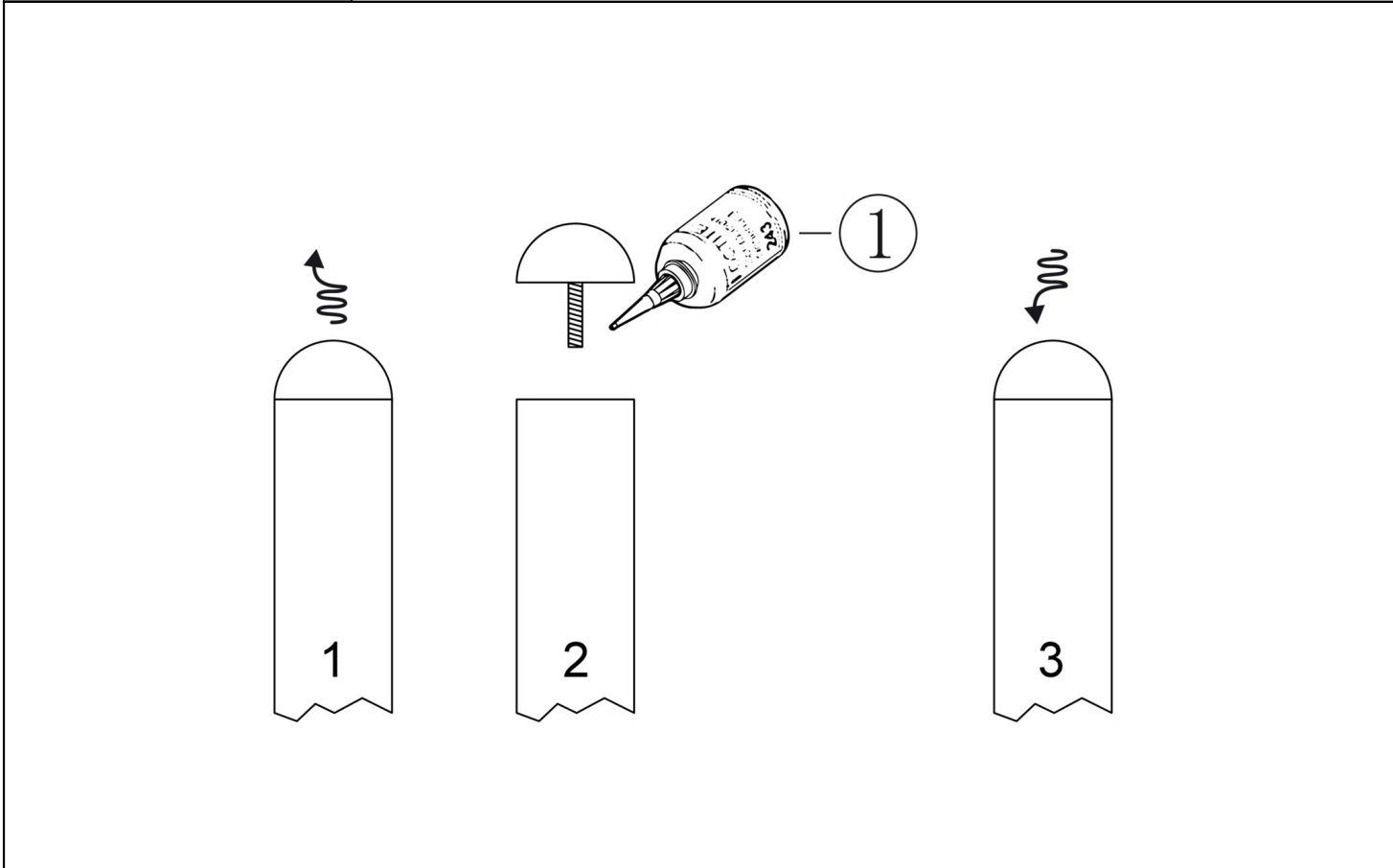
1



Bevestigings materiaal is per zakje verpakt en bovenstaande afbeelding zit in het zakje

Halve zeskant vloer HPL (4 staanders)

Hoofdafmetingen: 227x101x8,5cm

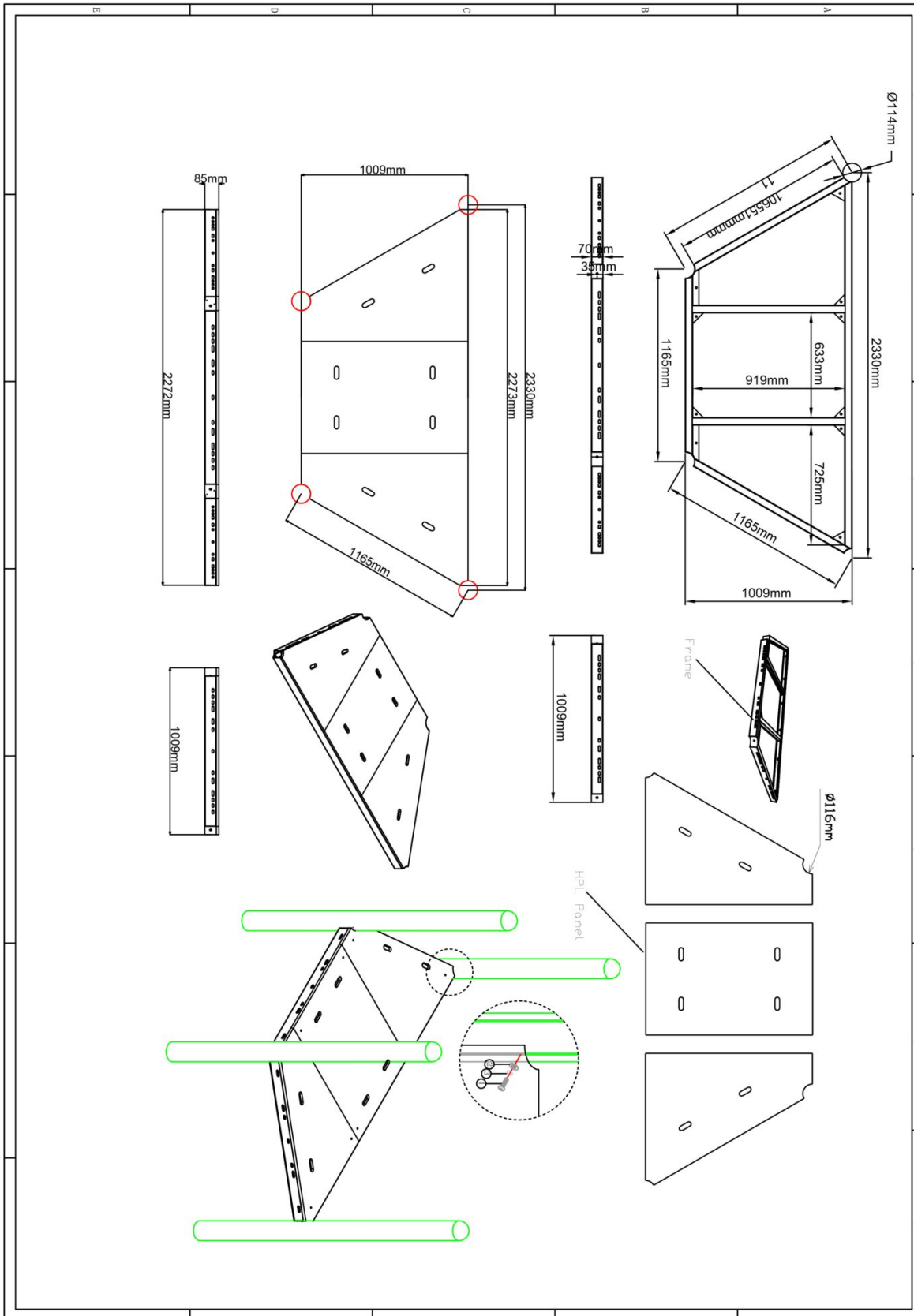

Halve zeskant vloer HPL (4 staanders)

STAP 1 van 1

Omschrijving: Bevestiging van de vloer aan de staander. In de staander zitten al voor gemonteerde M10 bussen op de juiste hoogte waar de bout ingedraaid dienen te worden.

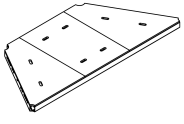
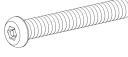
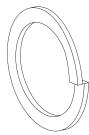
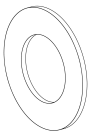
1 st. Halve zeskant vloer HPL (4 staanders)	4 st. Torx M10X30	4 st. Veerring M10	4 st. Ring M10 (middel)
			

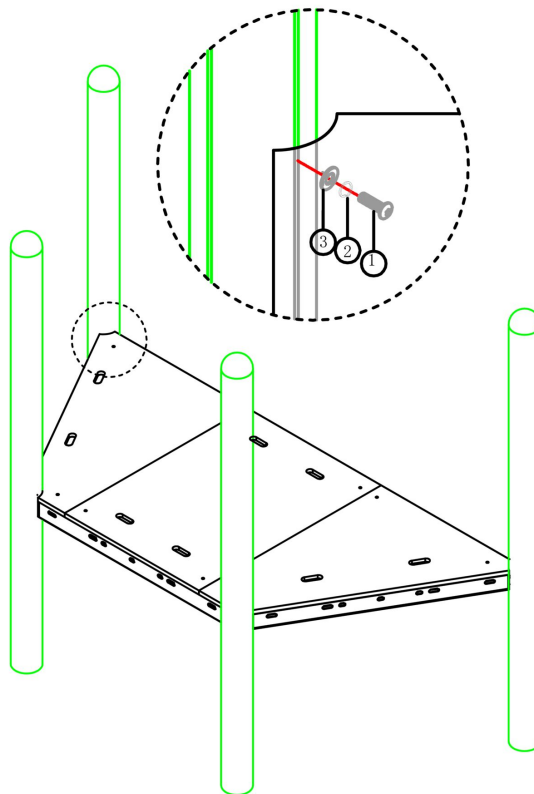

Bevestigings materiaal is per zakje verpakt en bovenstaande afbeelding zit in het zakje

Vloer driehoek HPL

Hoofdafmetingen: 113x165x8,5cm

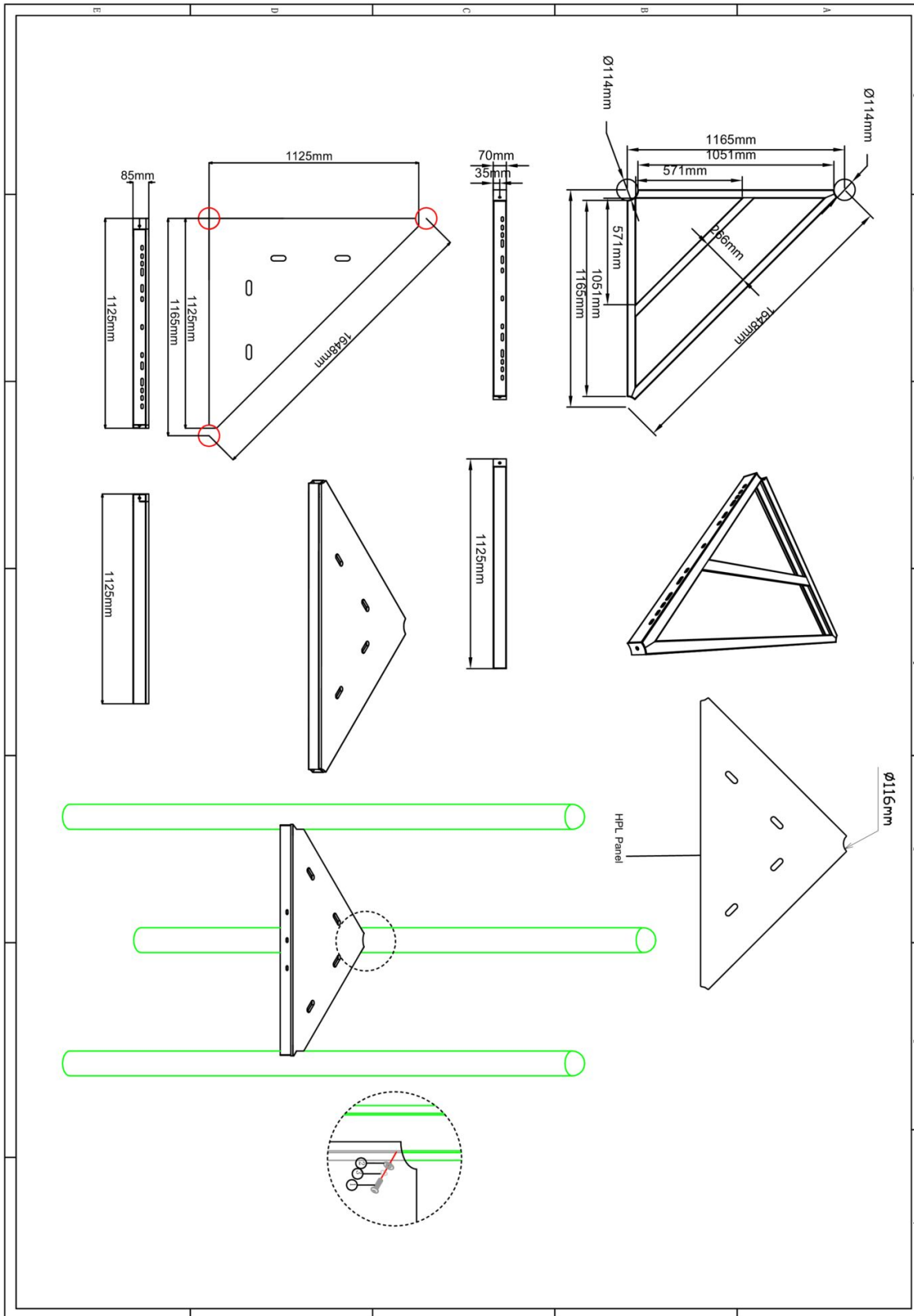

Vloer driehoek HPL

STAP 1 van 1

Omschrijving: Bevestiging van de vloer aan de staander. In de staander zitten al voor gemonteerde M10 bussen op de juiste hoogte waar de bout ingedraaid dienen te worden.

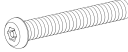
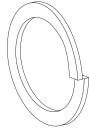
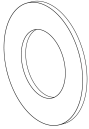
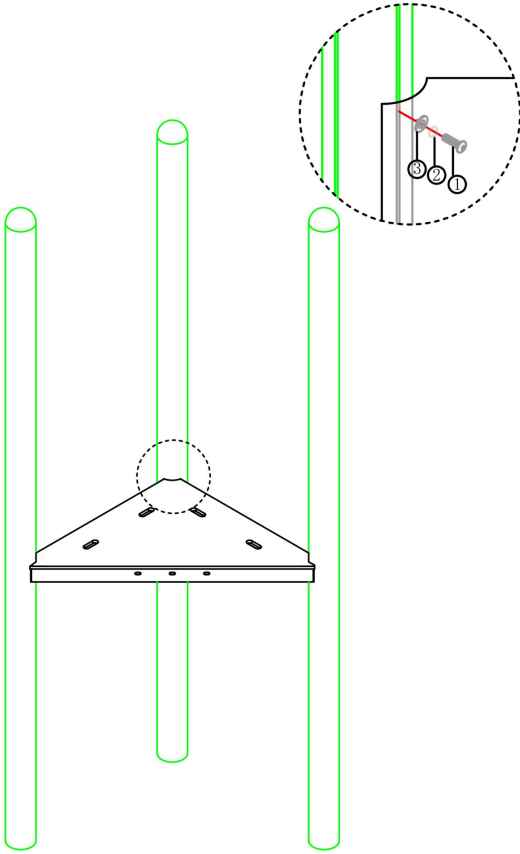
1 st. Vloer driehoek HPL	3 st. Torx M10X30	3 st. Veerring M10	3 st. Ring M10 (middel)
	<p>1</p> 	<p>2</p> 	<p>3</p> 
			
<p>Bevestigings materiaal is per zakje verpakt en bovenstaande afbeelding zit in het zakje</p>			

60cm tussentrap HPL

Hoofdafmetingen: 117x97x75cm

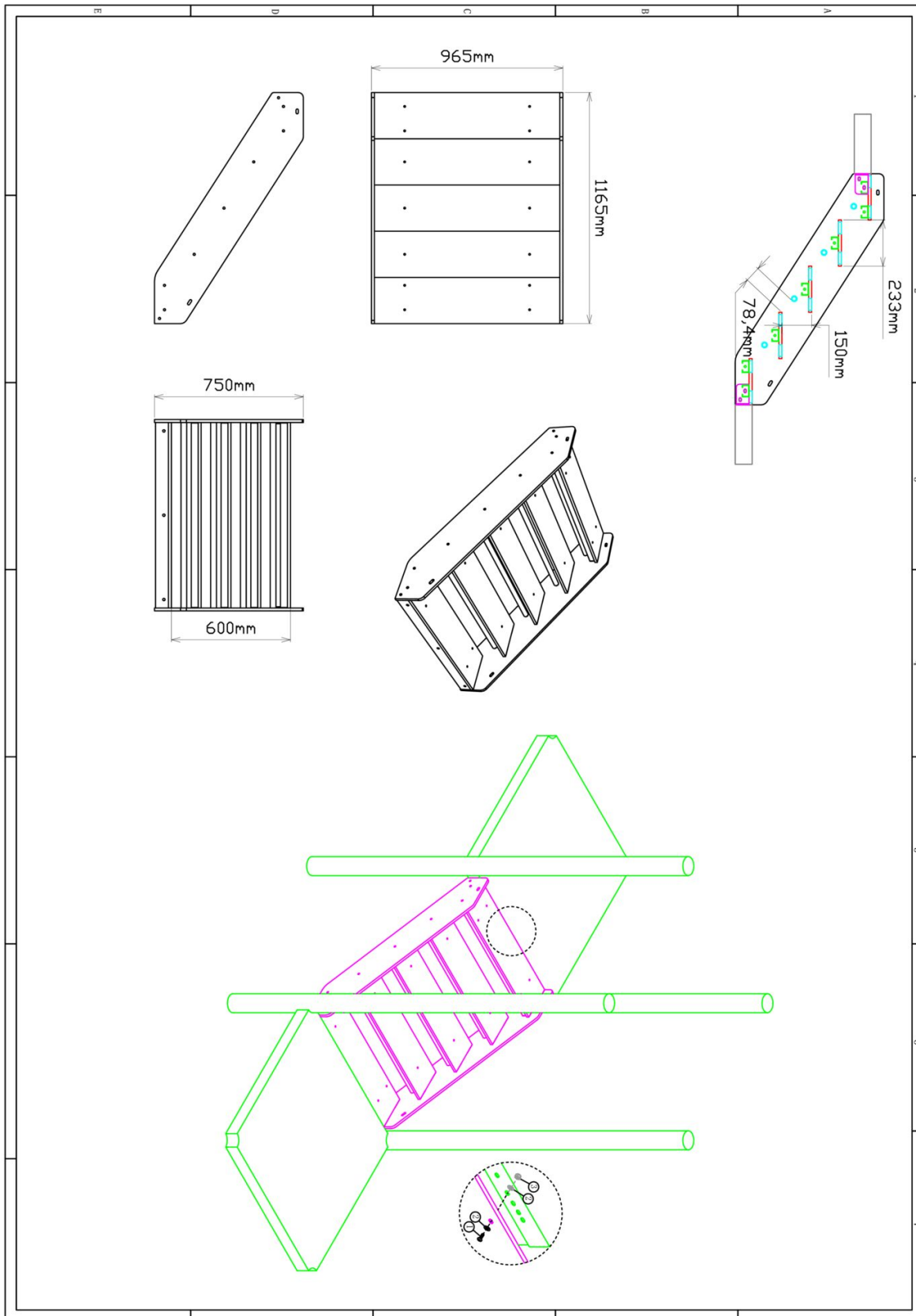

60cm tussentrap HPL

STAP 1 van 1

Omschrijving: Bevestiging tussen de trap en de vloeren

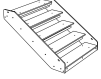
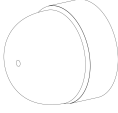
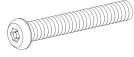
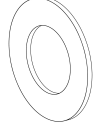
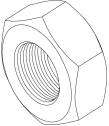
1 st. 60cm tussentrap HPL	6 st. Afdekdop M10	6 st. Torx M10X30	12 st. Ring M10 (middel)
		1 	2 
6 st. Lock Moer M10			
3 			

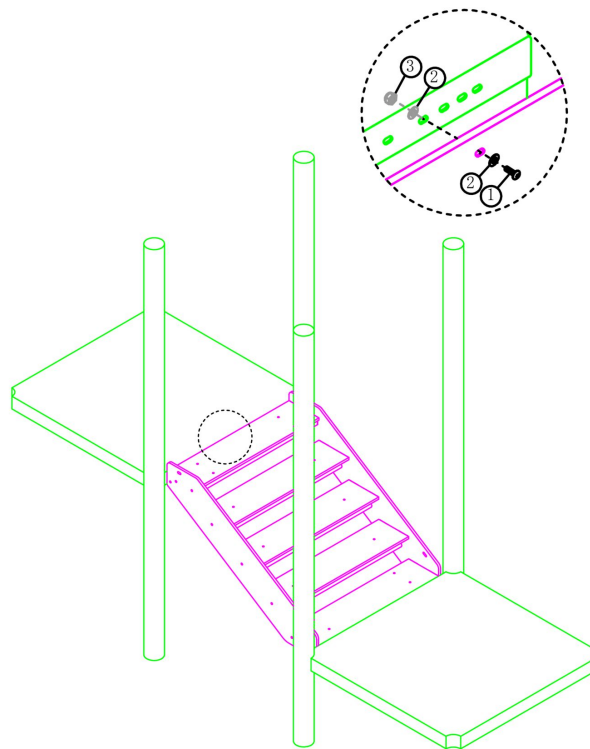

Bevestigings materiaal is per zakje verpakt en bovenstaande afbeelding zit in het zakje

60cm tussentrap railing HPL (per 2stuks)

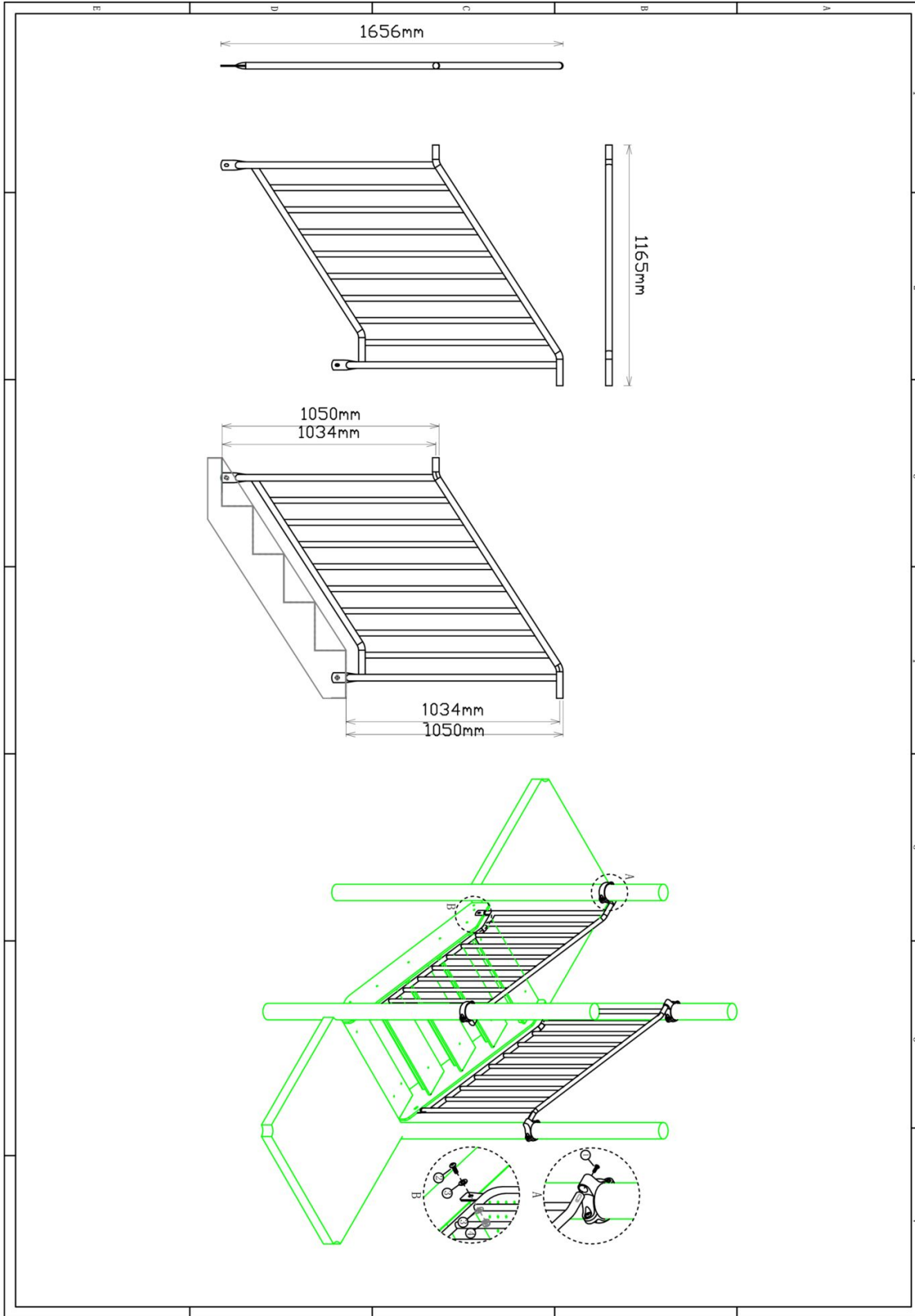

Hoofdafmetingen: 166x116,5cm



60cm tussentrap railing HPL (per 2stuks)

STAP 1 van 1

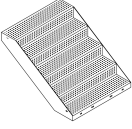
Omschrijving: Bevestiging van de railing aan de paal en trap

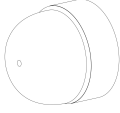
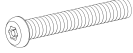
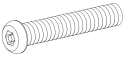
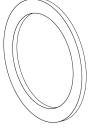
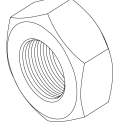
1 st. 60cm tussen-trap	4 st. Ring	4 st. Afdekdop M10	4 st. Torx M8X30
			
4 st. Torx M10X25	8 st. Ring M10 (groot)	4 st. Lock Moer M10	
			

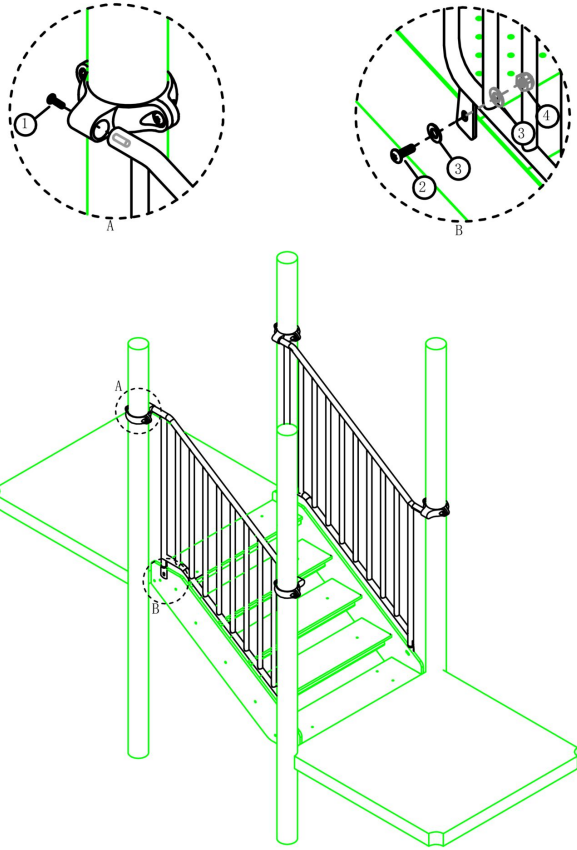

Bevestigings materiaal is per zakje verpakt en bovenstaande afbeelding zit in het zakje

Ruit paneel kunststof



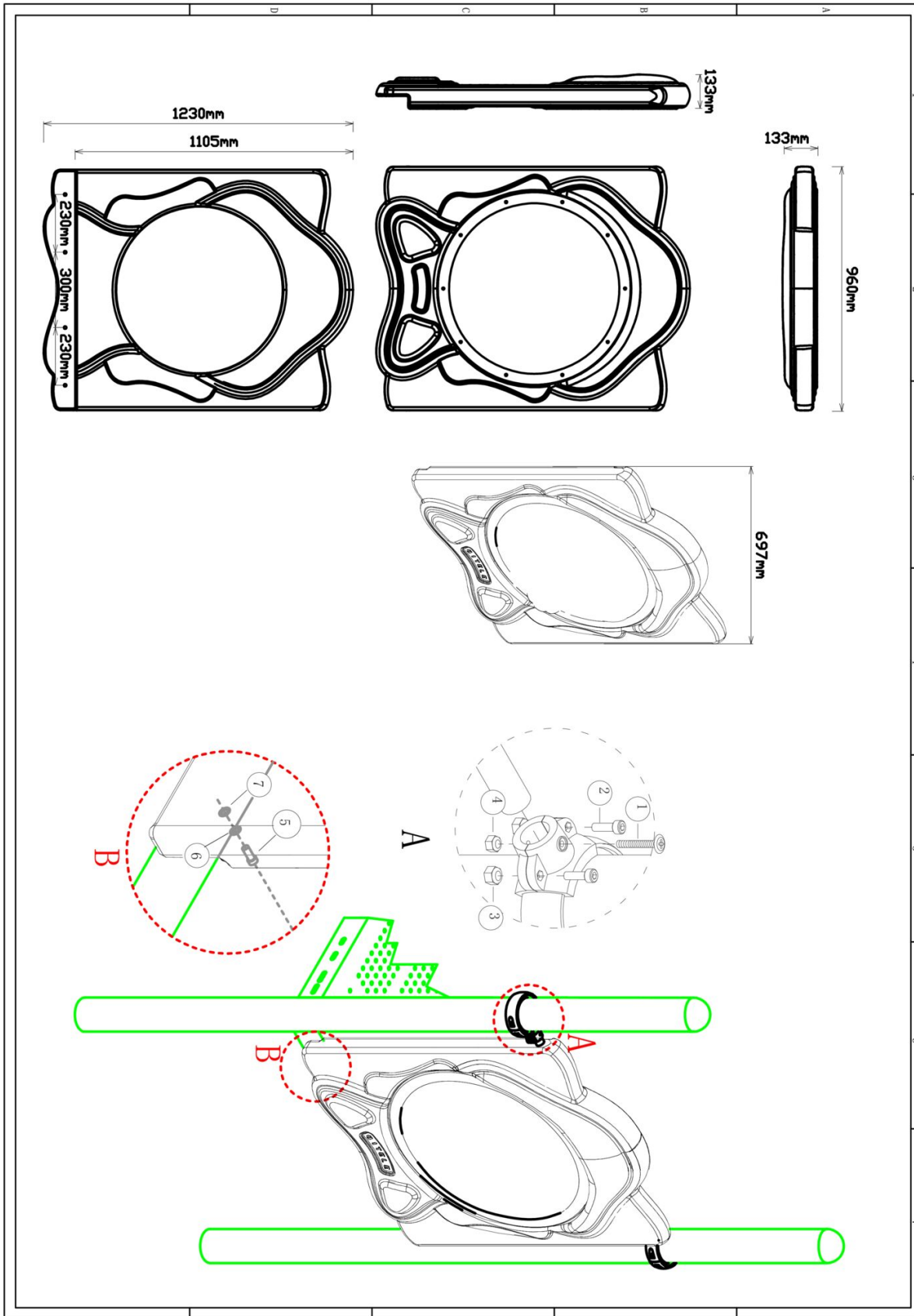



Hoofdafmetingen: 123x96x13cm

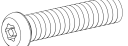

Ruit paneel kunststof

STAP 1 van 1

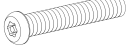
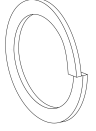
Omschrijving: Bevestiging van het paneel tussen vloer/staander

1 st. Raam paneel kunststof	2 st. Small clamp + ring	2 st. Kruiskop M6X65	4 st. Torx M8X20
		① 	② 
4 st. Lock Moer M8	2 st. Lock Moer M6	2 st. Torx M10X25	2 st. Veerring M10
③ 	④ 	⑤ 	⑥ 
2 st. Ring M10 (middel)			
⑦ 			

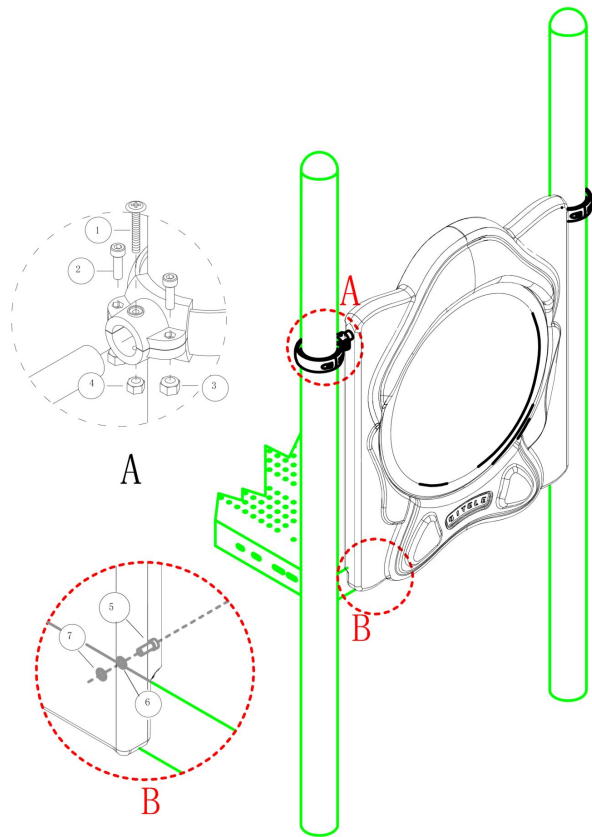

Bevestigings materiaal is per zakje verpakt en bovenstaande afbeelding zit in het zakje

X0 paneel kunststof(tussen palen)



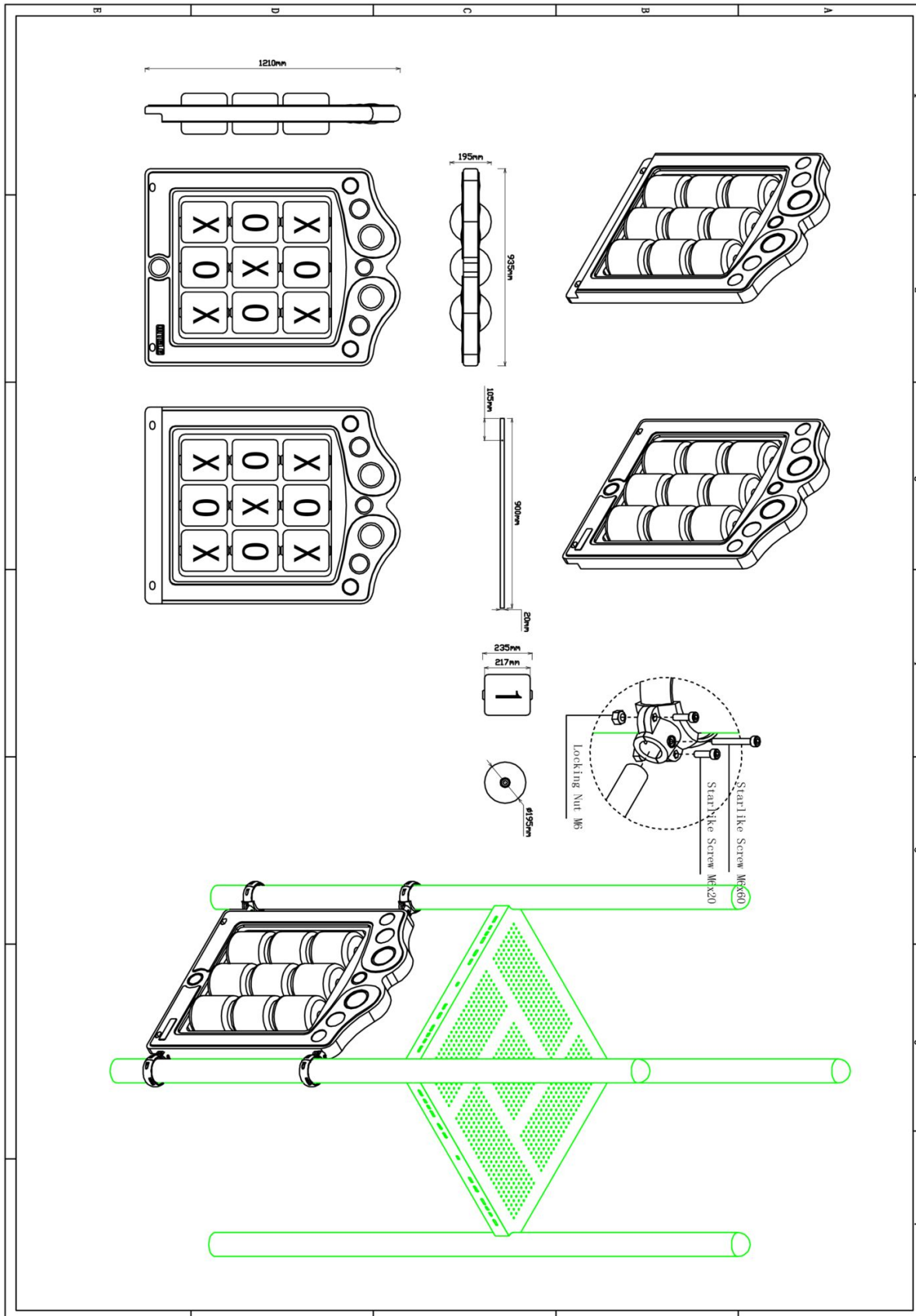

Hoofdafmetingen: 121x101x20cm

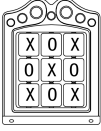

X0 paneel kunststof(tussen palen)

STAP 1 van 1

Omschrijving: Bevestiging van het paneel tussen de staanders

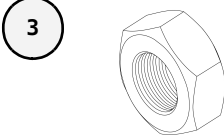
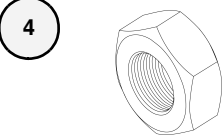
1 st. X0 paneel kunststof(tussen palen)	4 st. Small clamp + ring	4 st. Kruiskop M6X65	8 st. Torx M8X20
			
8 st. Lock Moer M8	4 st. Lock Moer M6		
			

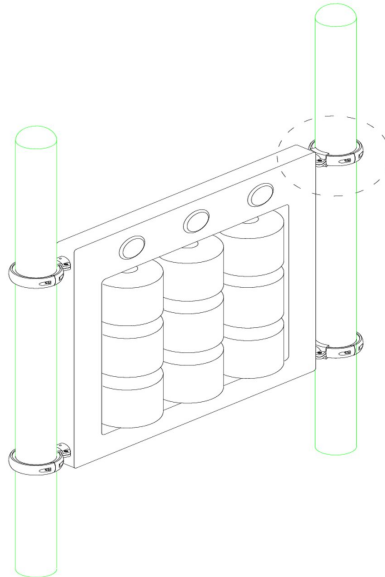
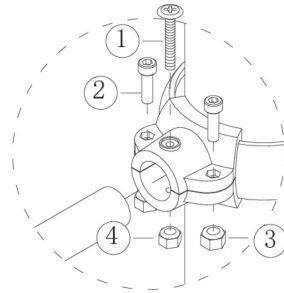

Bevestigings materiaal is per zakje verpakt en bovenstaande afbeelding zit in het zakje

Tandwielen paneel kunststof



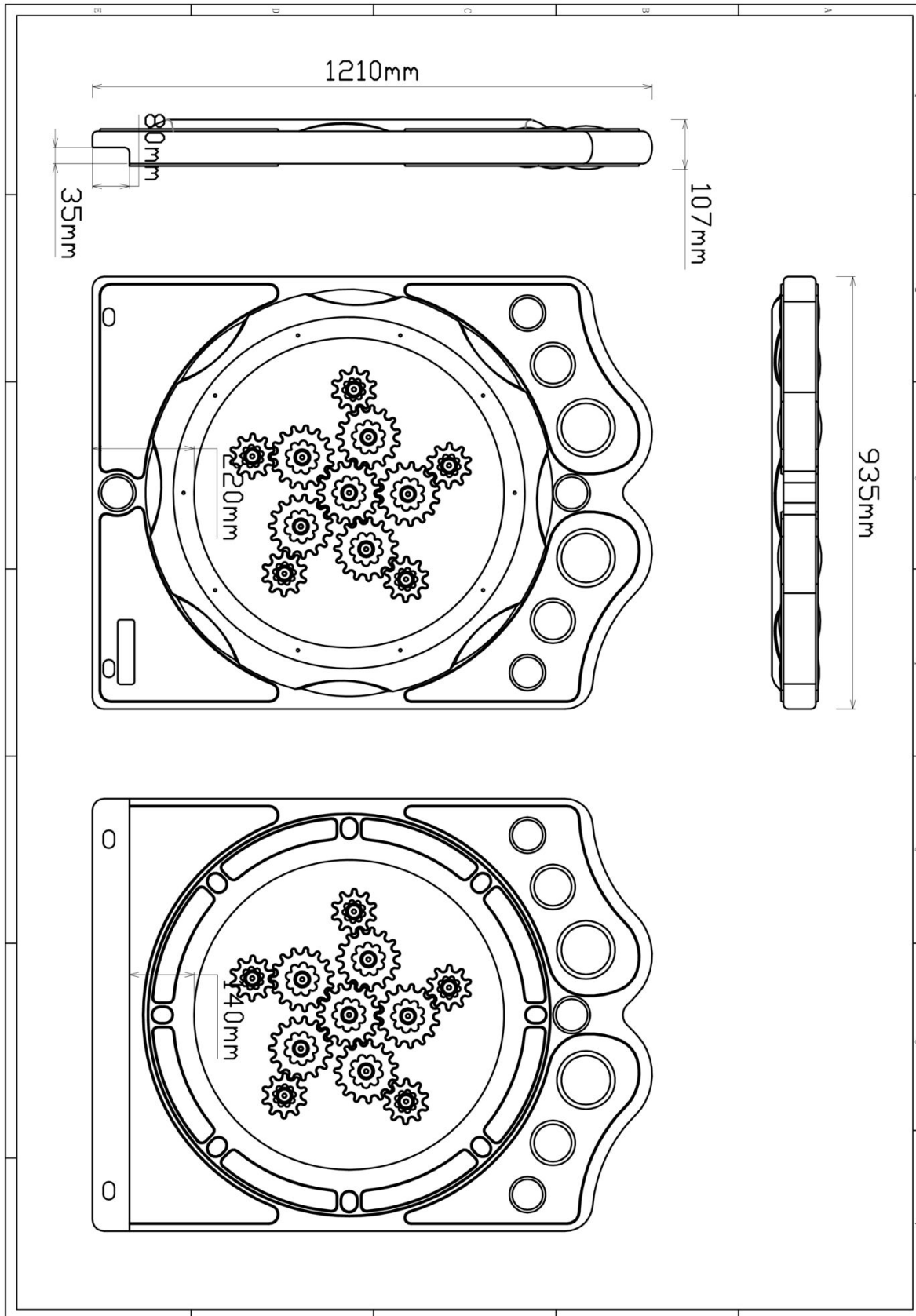





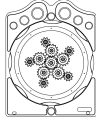

Hoofdafmetingen: 121x101x11cm

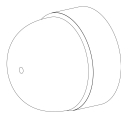

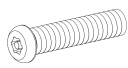
Tandwielen paneel kunststof

STAP 1 van 1

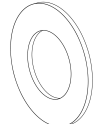
Omschrijving: Bevestiging van het paneel tussen vloer/staander

1 st. Tandwielen paneel kunststof	2 st. Small clamp + ring	2 st. Afdekdop M10	2 st. Kruiskop M6X65
			① 
4 st. Torx M8X20	4 st. Lock Moer M8	2 st. Lock Moer M6	2 st. Bout M10X50
② 	③ 	④ 	⑤ 
4 st. Ring M10 (middel)	2 st. Lock Moer M10		
⑥ 	⑦ 		

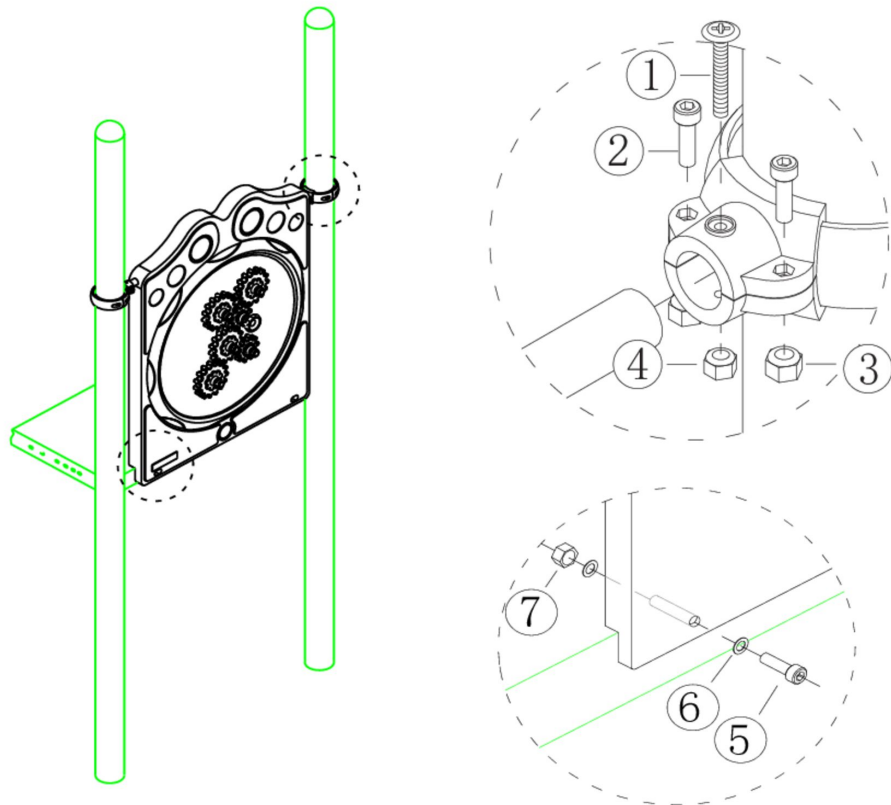

Bevestigings materiaal is per zakje verpakt en bovenstaande afbeelding zit in het zakje

90cm trap HPL

Hoofdafmetingen: 101x64x19cm

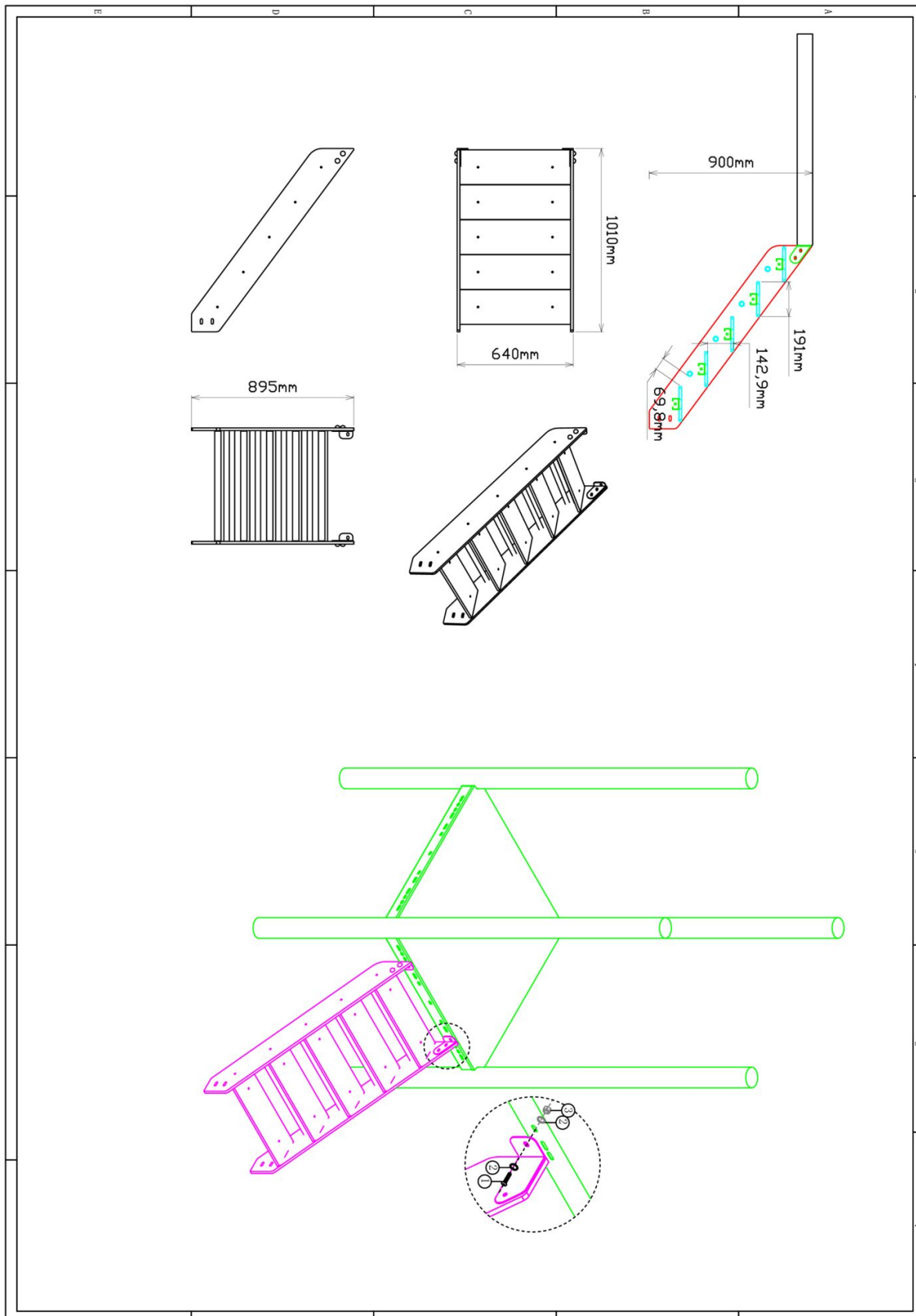

90cm trap HPL

STAP 1 van 1

Omschrijving: Bevestiging van de trap aan de vloer

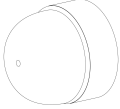
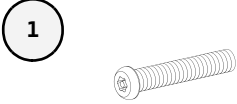
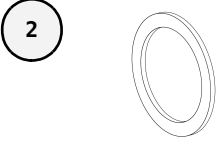
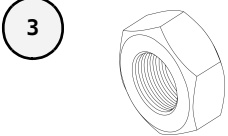
1 st. 90cm trap HPL	3 st. Afdekdop M10	3 st. Torx M10X25	6 st. Ring M10 (groot)
			
3 st. Lock Moer M10			
			

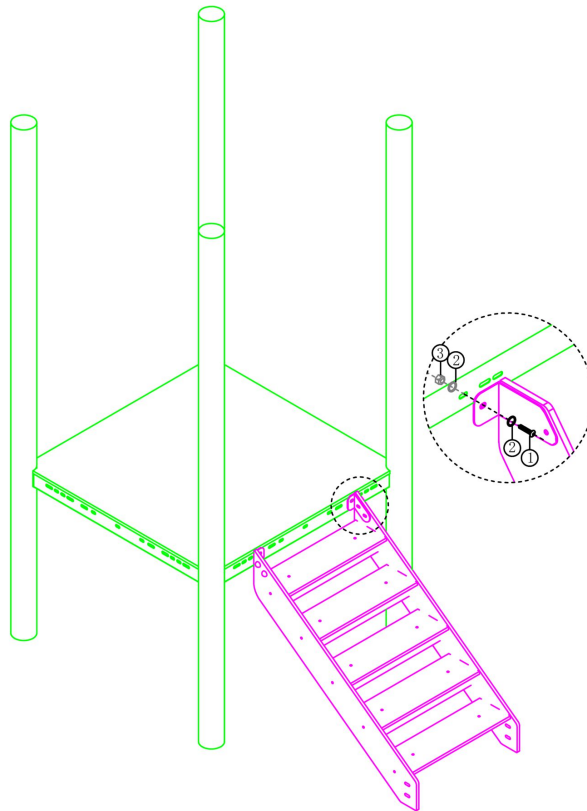

Bevestigings materiaal is per zakje verpakt en bovenstaande afbeelding zit in het zakje

90cm trapleuningen HPL (2 stuks)

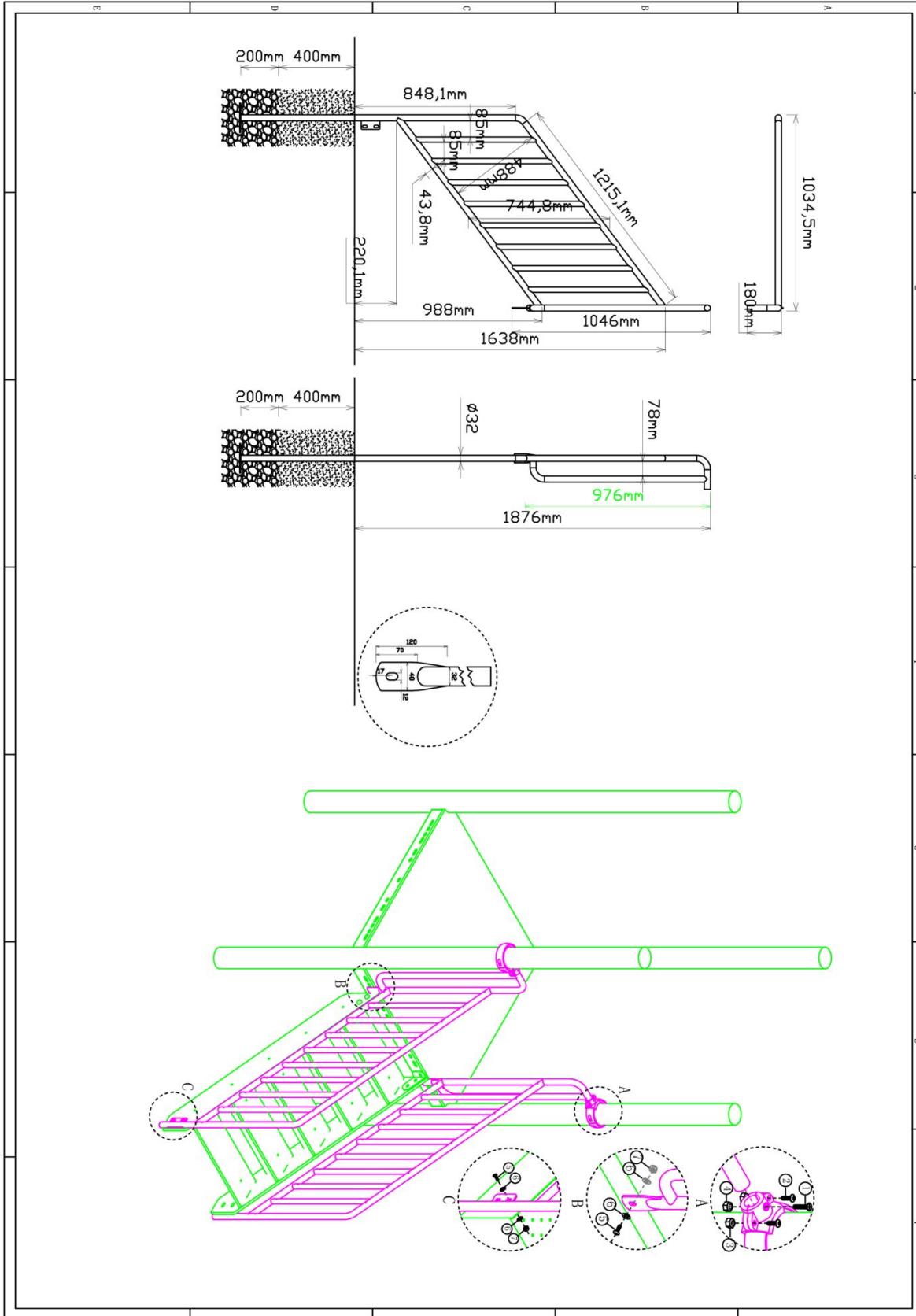

Hoofdafmetingen: 248x103x18cm



90cm trapleuningen HPL (2 stuks)

STAP 1 van 1

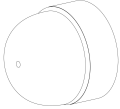
Omschrijving: Bevestiging van de trapleuning aan de vloer, staander en de trap

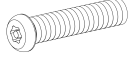
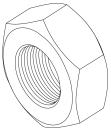
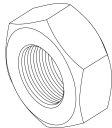
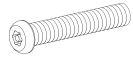
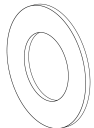
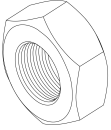
2 st. Small clamp + ring	6 st. Afdekdop M10	2 st. Kruiskop M6X65	4 st. Torx M8X20
		① 	② 
4 st. Lock Moer M8	2 st. Lock Moer M6	6 st. Torx M10X25	12 st. Ring M10 (middel)
③ 	④ 	⑤ 	⑥ 
6 st. Lock Moer M10			
⑦ 			

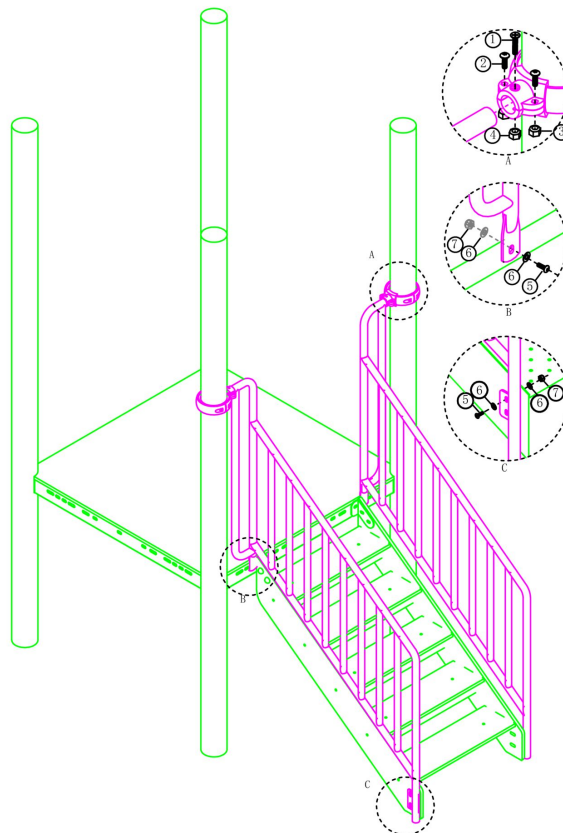

Bevestigings materiaal is per zakje verpakt en bovenstaande afbeelding zit in het zakje

Hek Driehoeksvloer voor verticale opgang

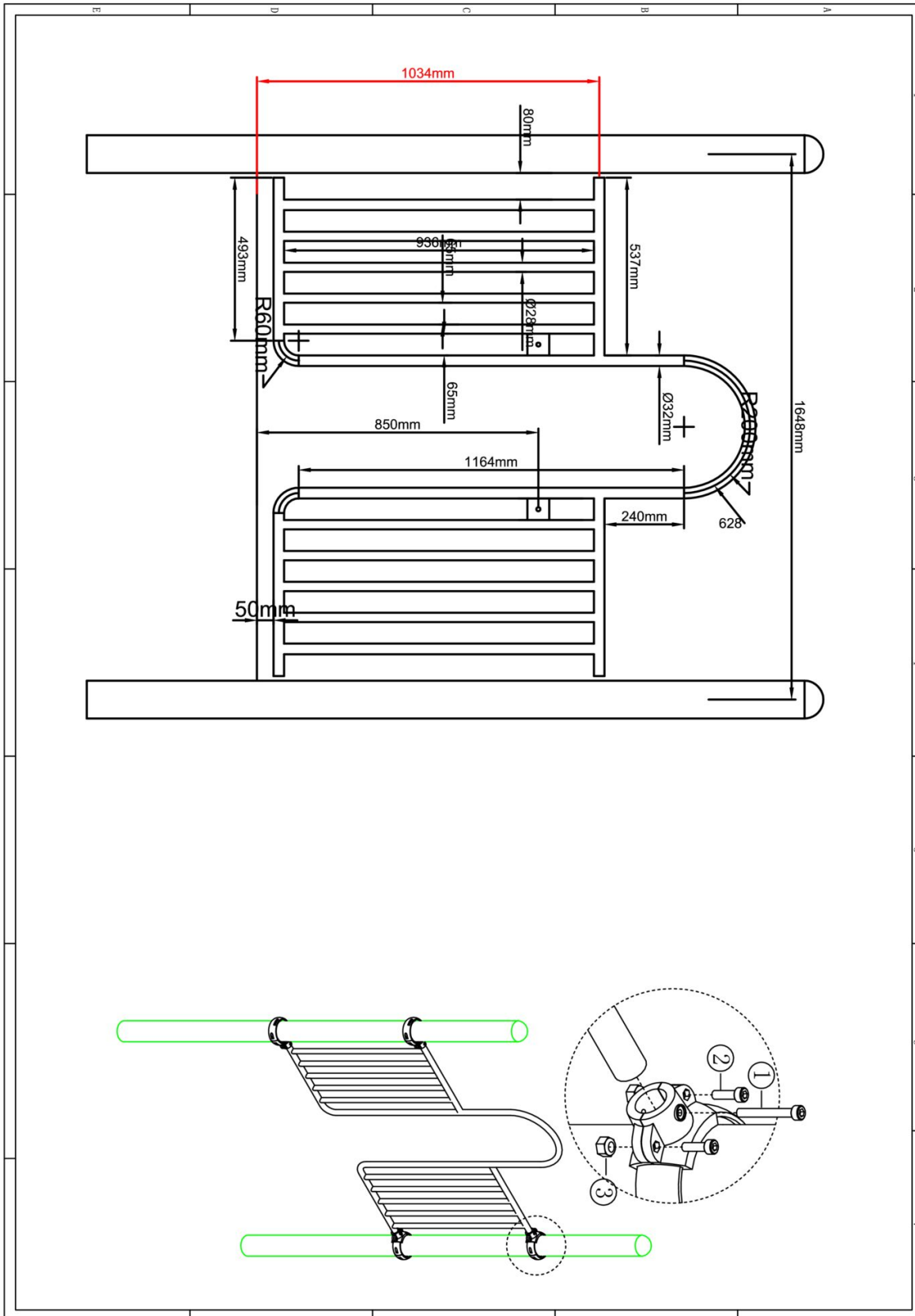

Hoofdafmetingen: 145x156cm



Hek Driehoeksvloer voor verticale opgang

STAP 1 van 1

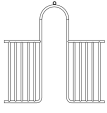
Omschrijving: Bevestiging van het hek tussen de vloer/staander

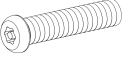
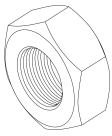
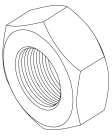
1 st. Hek Driehoeksvloer met bevestiging	4 st. Small clamp + ring	4 st. Kruiskop M6X65	8 st. Torx M8X20
			
8 st. Lock Moer M8	4 st. Lock Moer M6		
			

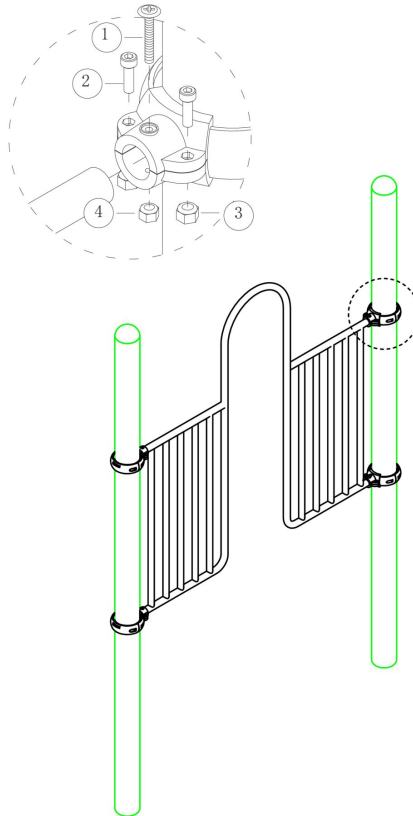

Bevestigings materiaal is per zakje verpakt en bovenstaande afbeelding zit in het zakje

90cm Vertical Climber

Hoofdafmetingen: 230x55x45cm

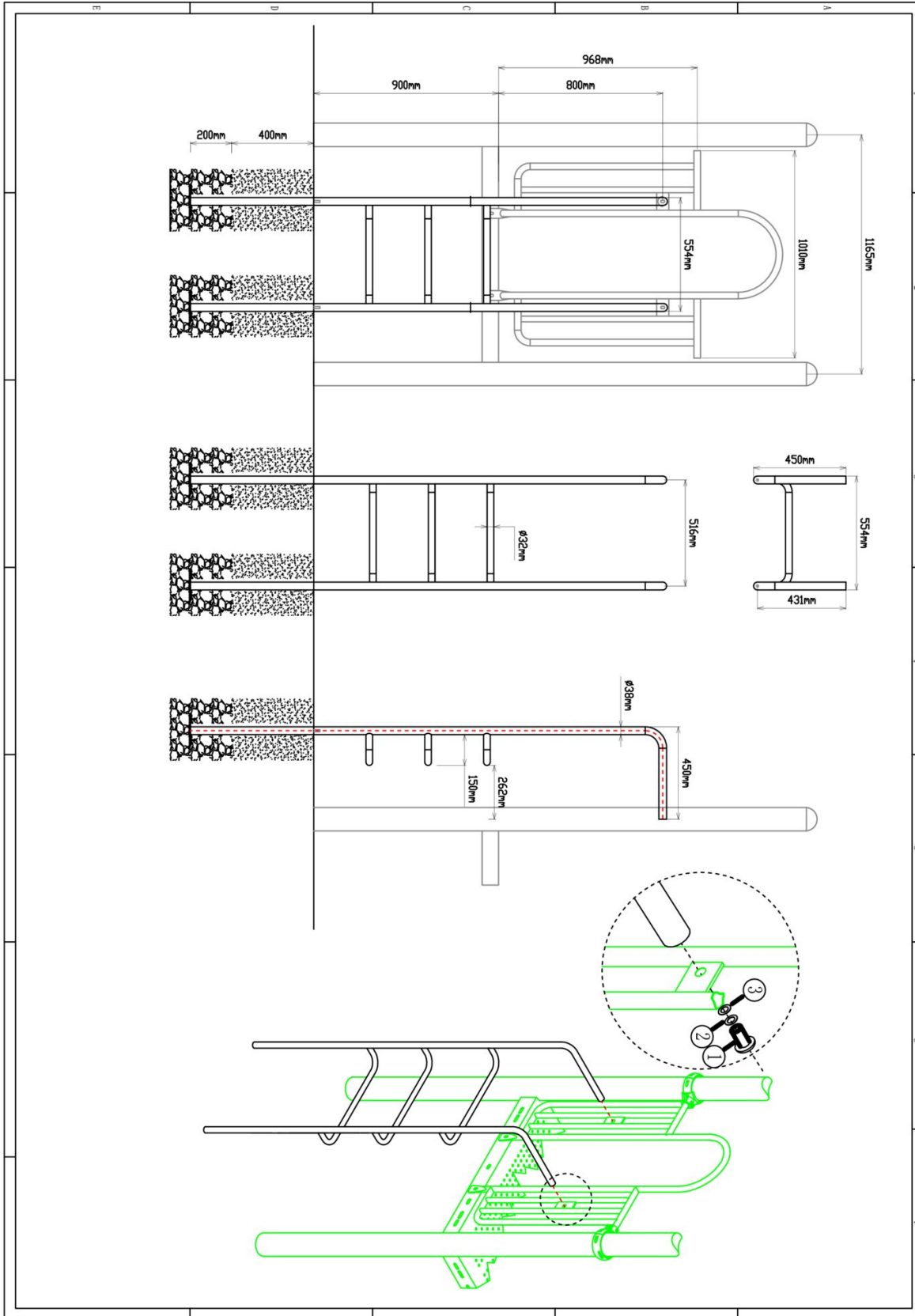

90cm Vertical Climber

STAP 1 van 1

Omschrijving: Bevestiging tussen de Vertical climber en het hek

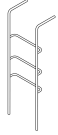
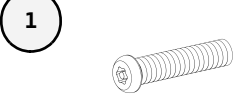
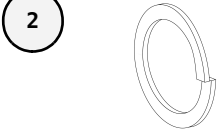
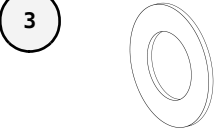
1 st. 90cm Vertical Climber	2 st. Torx M10X20	2 st. Veerring M10	2 st. Ring M10 (middel)
			

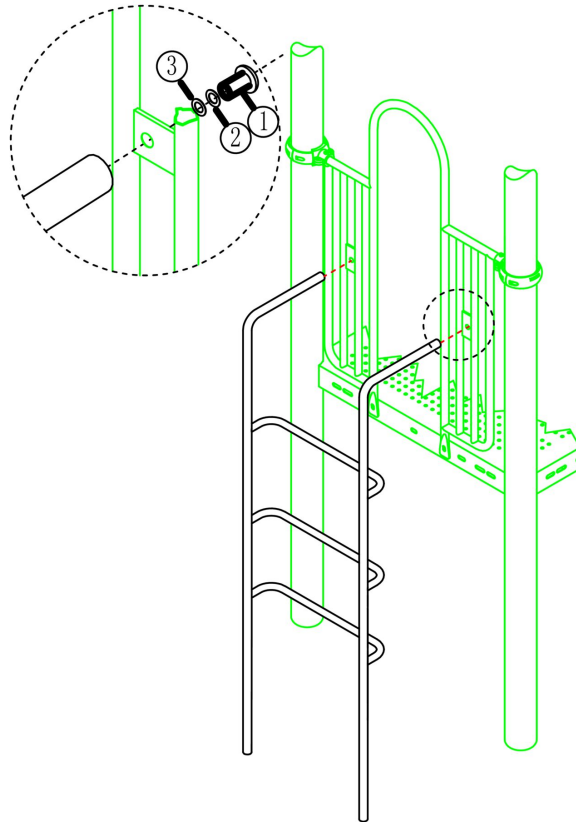

Bevestigings materiaal is per zakje verpakt en bovenstaande afbeelding zit in het zakje

Hekje tbv Snake climber

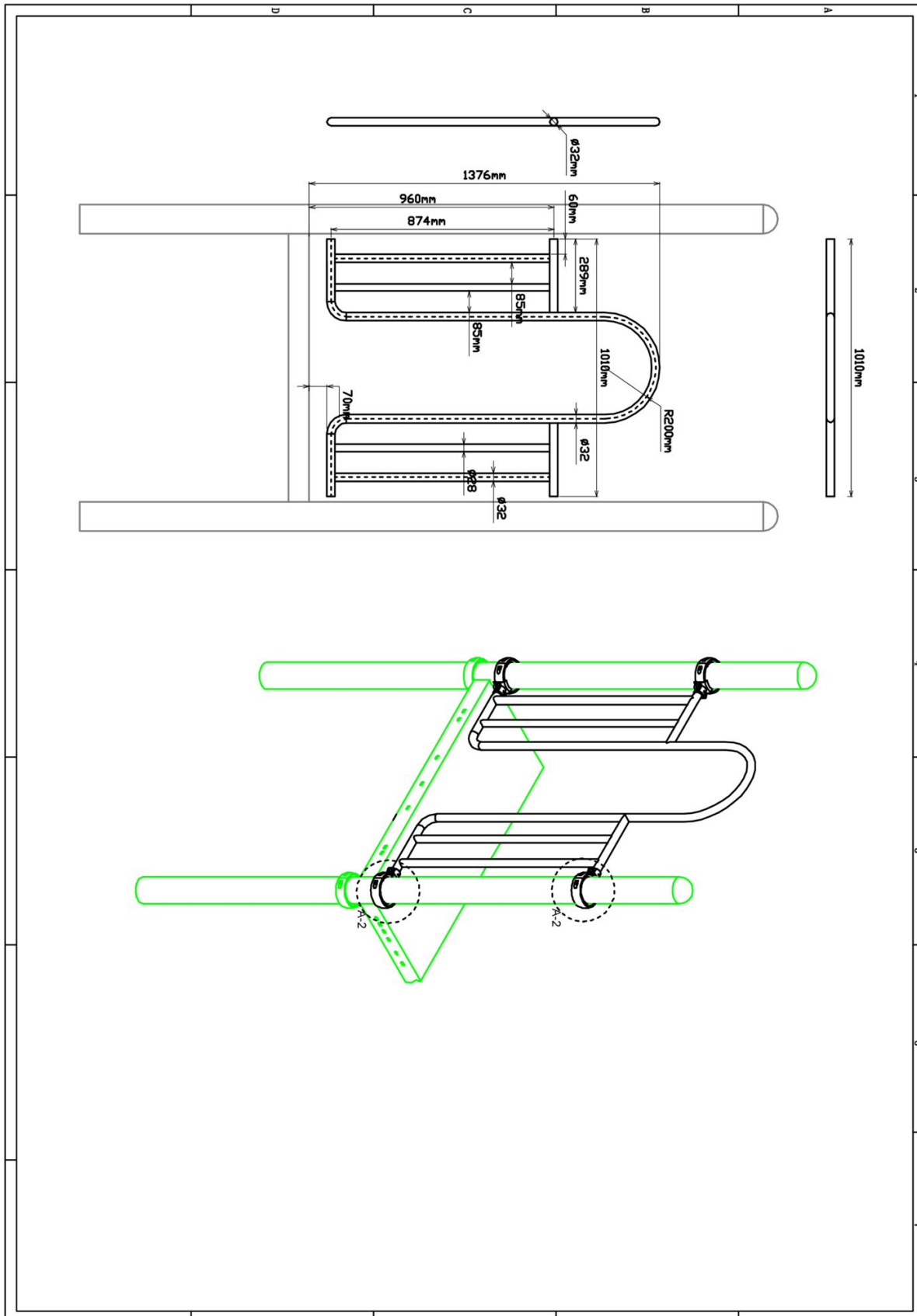

Hoofdafmetingen: 138x101cm



Hekje tbv Snake climber

STAP 1 van 1

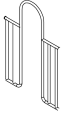
Omschrijving: Bevestiging van het paneel tussen de staanders

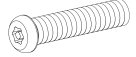
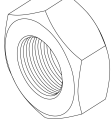
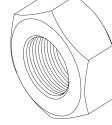
1 st. Hekje tbv Snake climber	4 st. Small clamp + ring	4 st. Kruiskop M6X65	8 st. Torx M8X20
		1 	2 
8 st. Lock Moer M8	4 st. Lock Moer M6		
3 	4 		

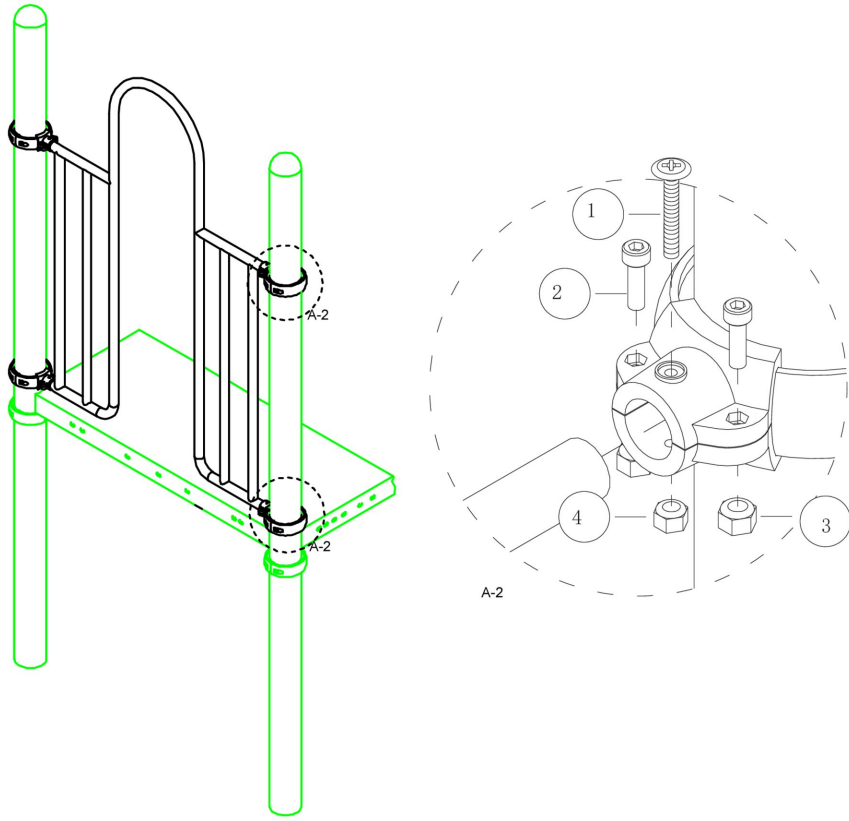

Bevestigings materiaal is per zakje verpakt en bovenstaande afbeelding zit in het zakje

150cm Curve climber



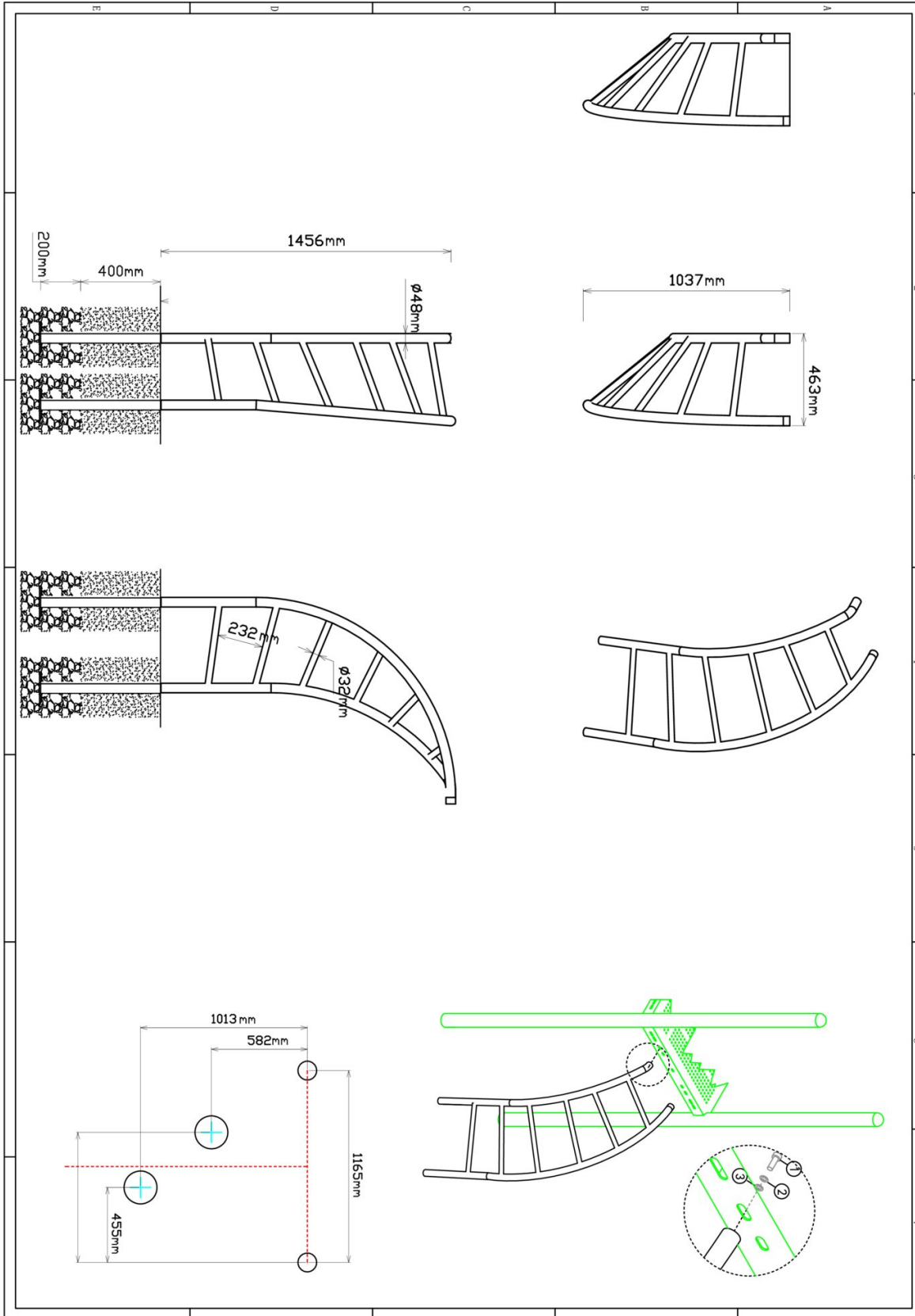



Hoofdafmetingen: 206x104x46cm

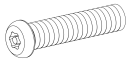

150cm Curve climber

STAP 1 van 1

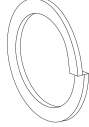
Omschrijving: Bevestiging tussen curve climber en vloer

1 st. 150cm Curve climber	2 st. Torx M10X20	2 st. Veerring M10	2 st. Ring M10 (middel)
	 	 	 

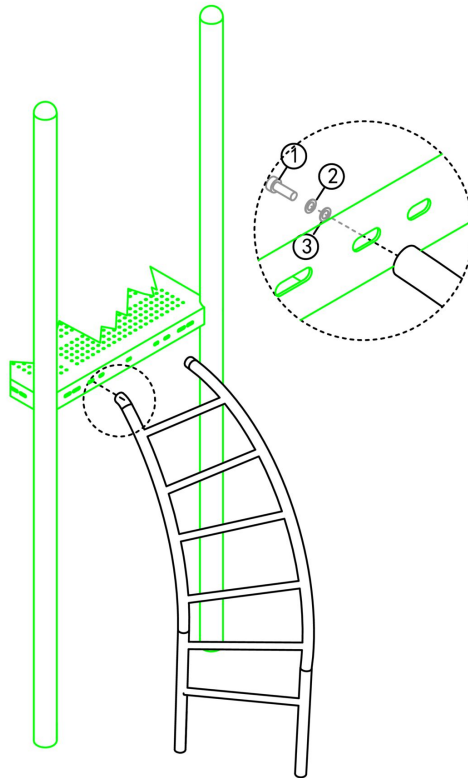





Bevestigings materiaal is per zakje verpakt en bovenstaande afbeelding zit in het zakje

Hekje zonder bevestiging (boven)

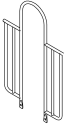
STAP 1 van 1

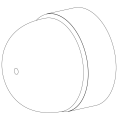
Omschrijving: Bevestiging van het hek tussen de vloer/staander

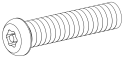
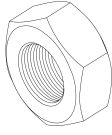
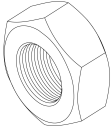
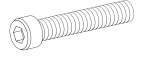
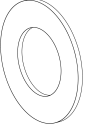
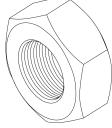
1 st. Hekje zonder bevestiging (boven)	2 st. Small clamp + ring	2 st. Afdekdop M10	2 st. Kruiskop M6X65
			
4 st. Torx M8X20	4 st. Lock Moer M8	2 st. Lock Moer M6	2 st. Bout M10X25
			
4 st. Ring M10 (middel)	2 st. Lock Moer M10		
			

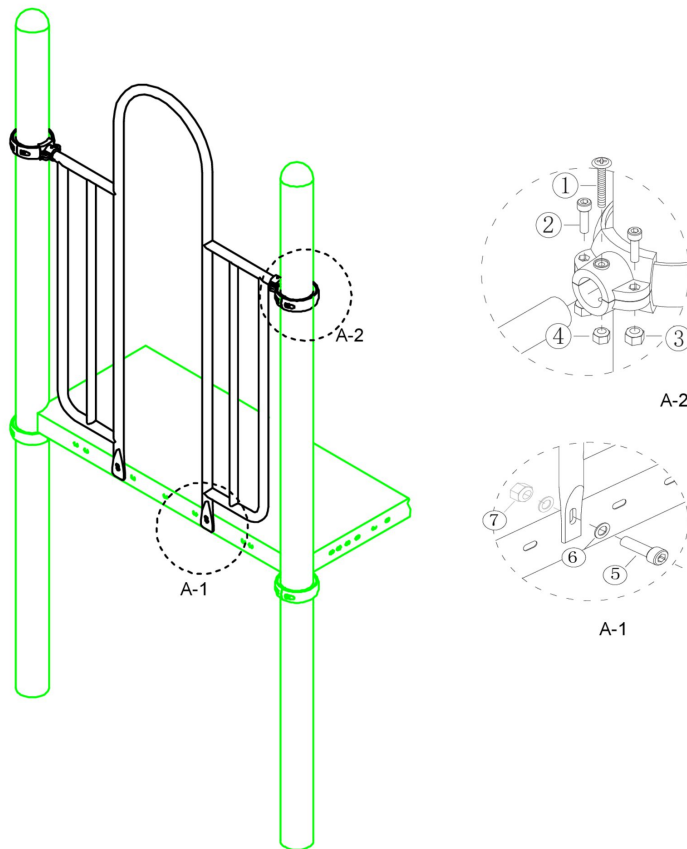

Bevestigings materiaal is per zakje verpakt en bovenstaande afbeelding zit in het zakje

Stangenopgang 90cm

Hoofdafmetingen: 3,2x101 (stang 1x)

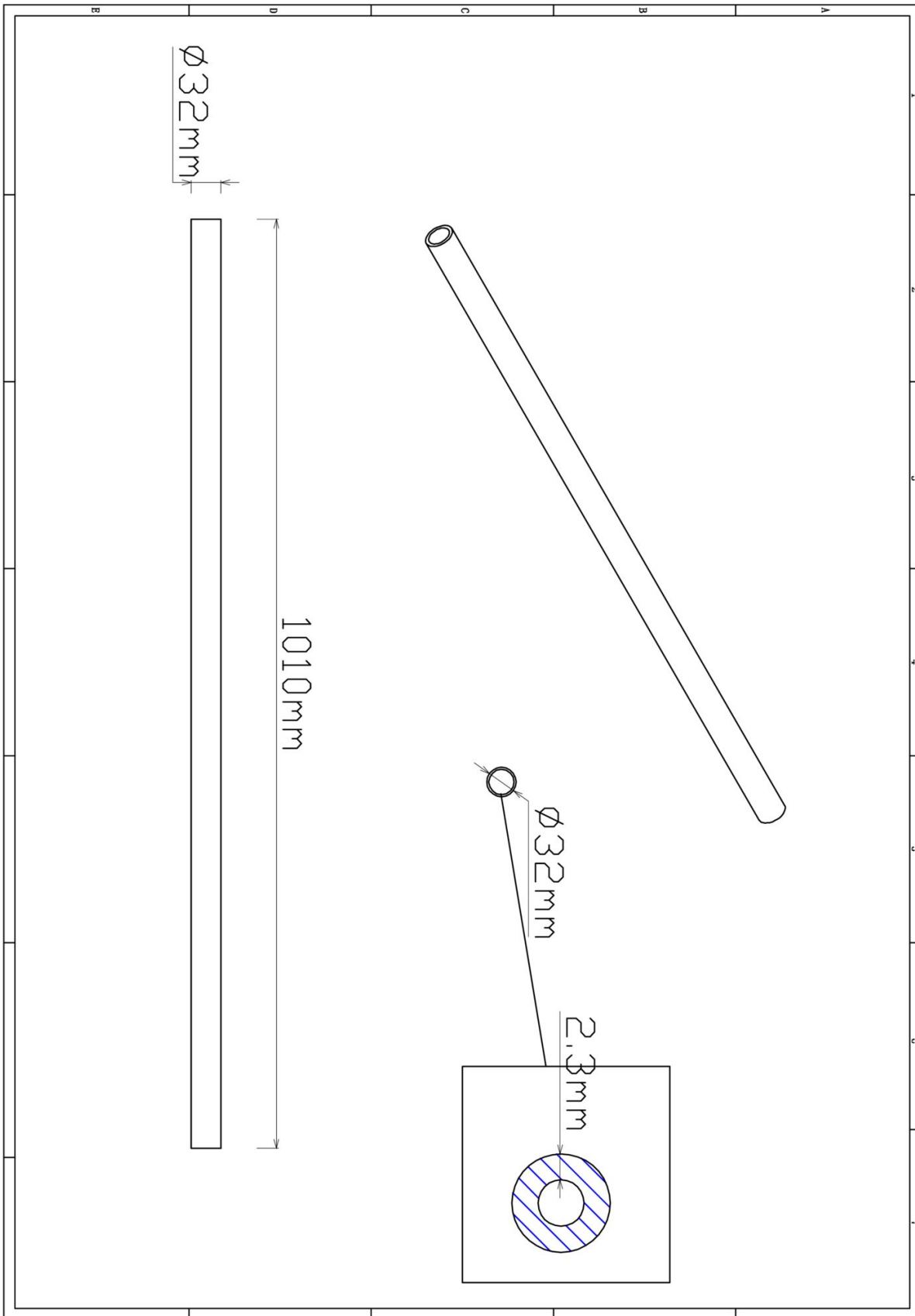

Stangenopgang 90cm

STAP 1 van 3

Omschrijving: Zelftap bouten aanbrengen aan de binnenkant van de palen

2 st. Zeskant M3X16
Zelftap

1

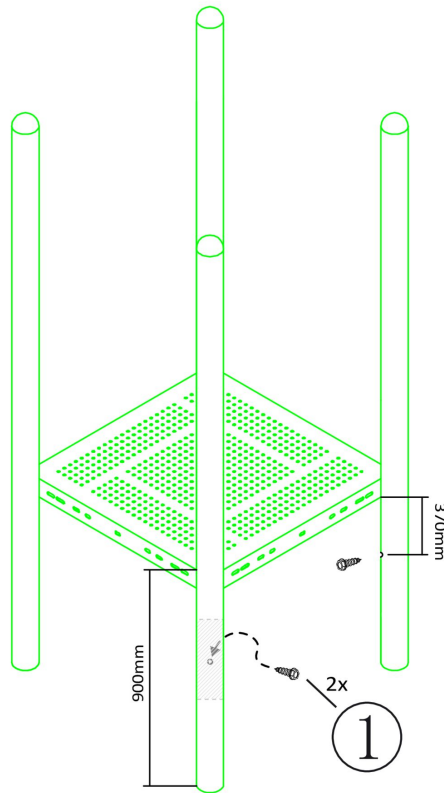

Bevestigings materiaal is per zakje verpakt en bovenstaande afbeelding zit in het zakje

Stangenopgang 90cm

STAP 2 van 3

Omschrijving: Koppelingsring over de schroef schuiven en vastzetten zodat de schroef niet meer zichtbaar is en de ring door de schroef niet kan zakken op de paal

4 st. Small clamp + ring

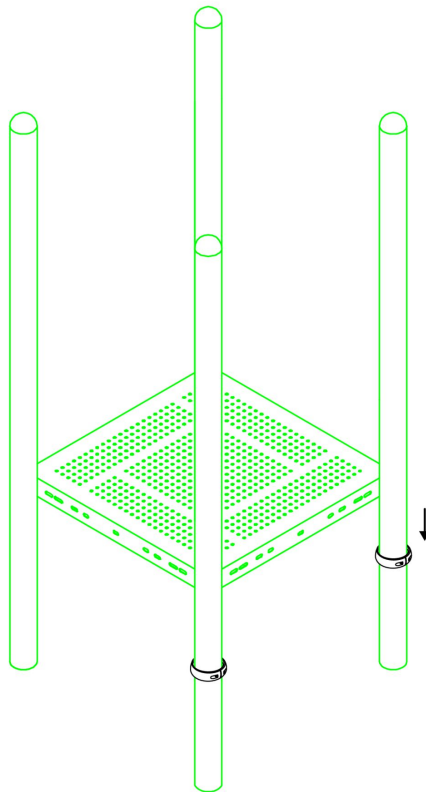

Bevestigings materiaal is per zakje verpakt en bovenstaande afbeelding zit in het zakje

Stangenopgang 90cm

STAP 3 van 3

Omschrijving: Stang vastzetten met behulp van de klemmen

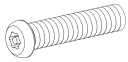
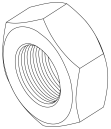
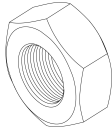
2 st. Kruiskop M6X65	4 st. Torx M8X20
1 	2 
4 st. Lock Moer M8	2 st. Lock Moer M6
3 	4 

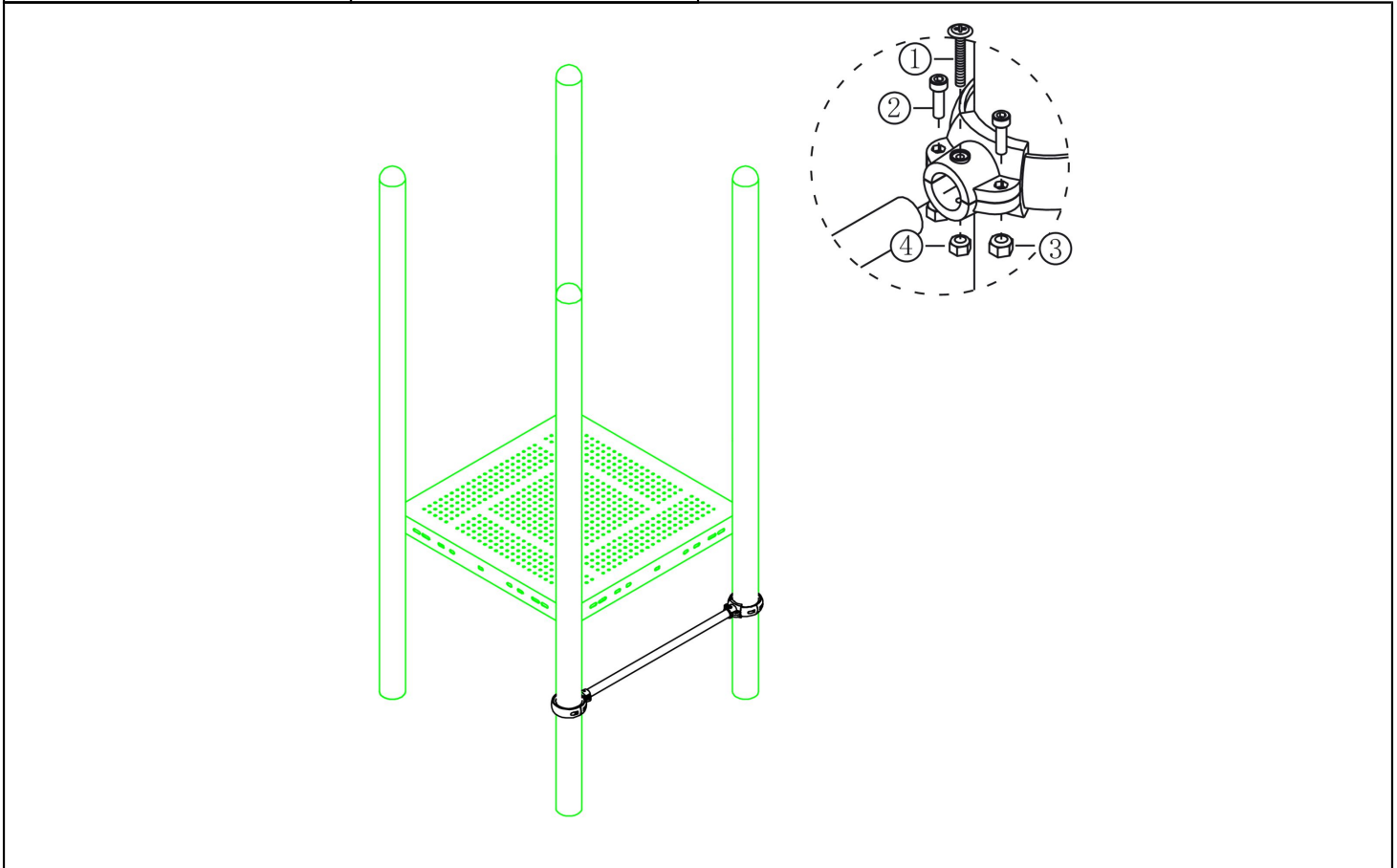

Bevestigings materiaal is per zakje verpakt en bovenstaande afbeelding zit in het zakje

Hekje tbv glijstang



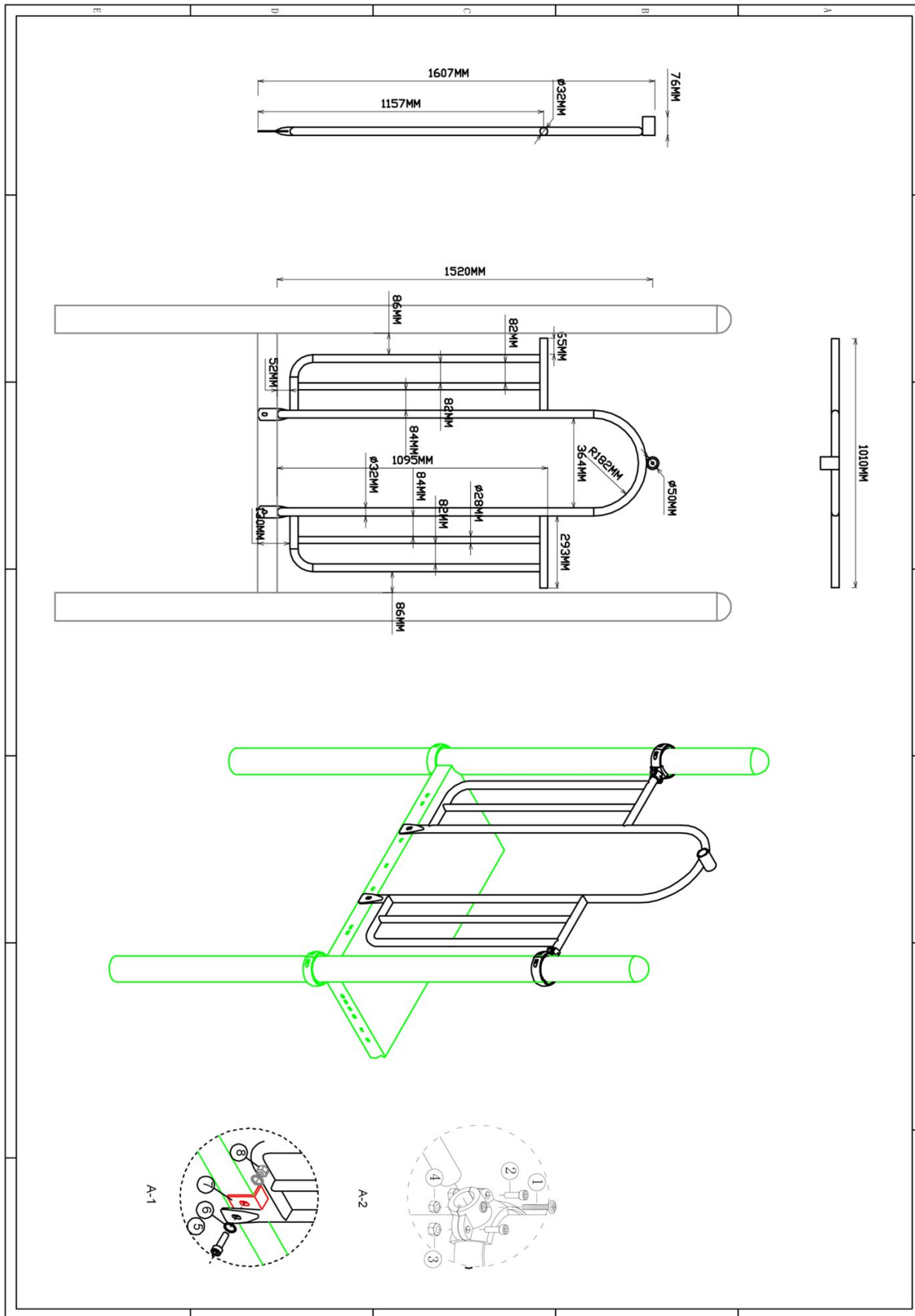





Hoofdafmetingen: 152x101cm

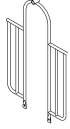

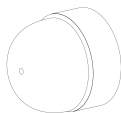
Hekje tbv glijstang

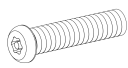
STAP 1 van 1

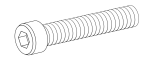
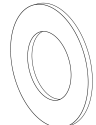
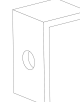
Omschrijving: Bevestiging van het hek tussen de vloer/staander

1 st. Hekje tbv glijstang	2 st. Small clamp + ring	2 st. Afdekdop M10	2 st. Kruiskop M6X65
			
4 st. Torx M8X20	4 st. Lock Moer M8	2 st. Lock Moer M6	2 st. Bout M10X25
			
4 st. Ring M10 (middel)	2 st. Hoekje	2 st. Lock Moer M10	
			

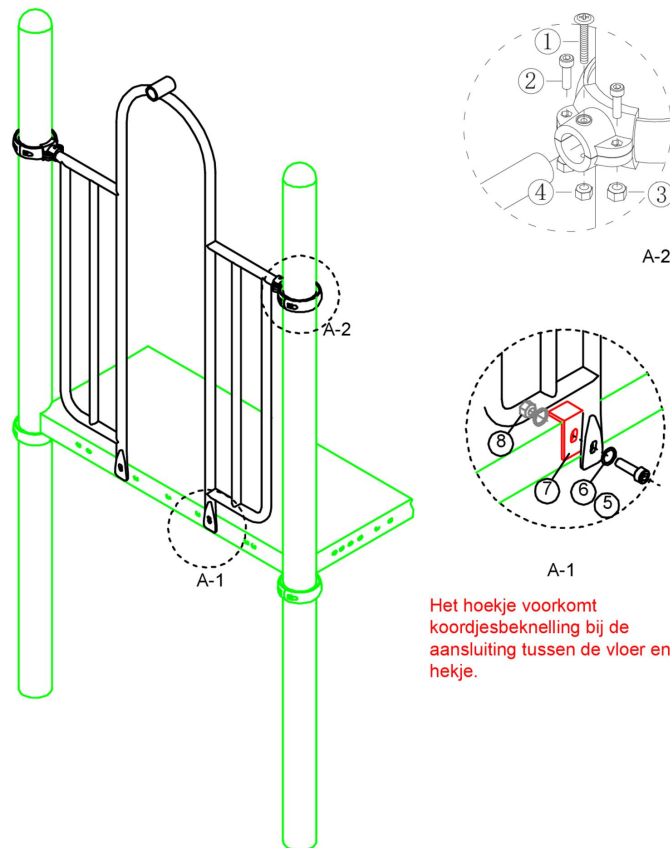

Het hoekje voorkomt koordjesbeknelling bij de aansluiting tussen de vloer en het hekje.

Bevestigings materiaal is per zakje verpakt en bovenstaande afbeelding zit in het zakje

150cm Glijstang

Hoofdafmetingen: 362x42cm

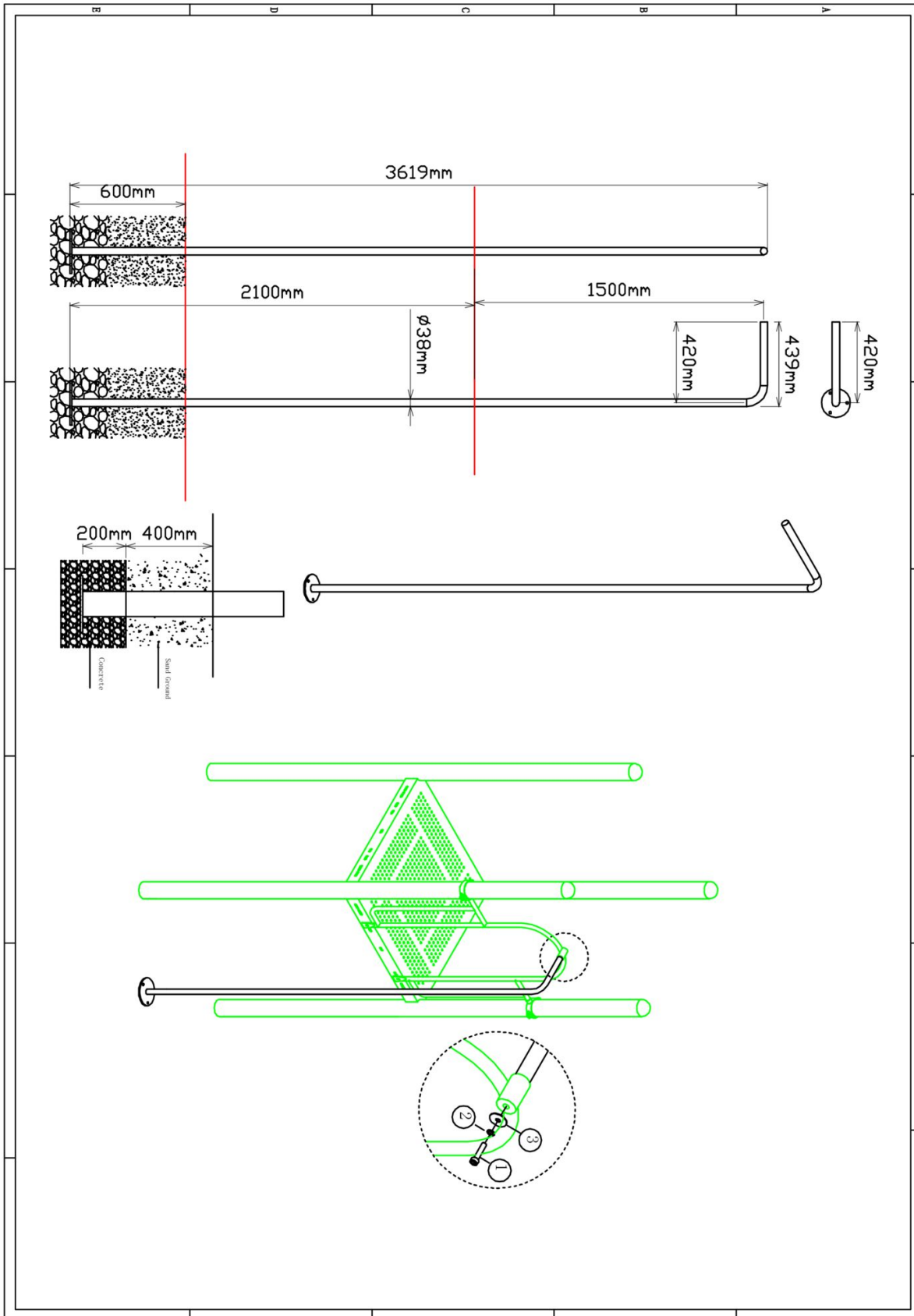

150cm Glijstang

STAP 1 van 1

Omschrijving: Bevestiging tussen de glijstang en het hek

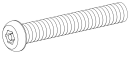
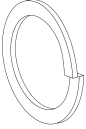
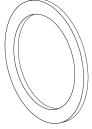
1 st. 150cm Glijstang	1 st. Torx M10X30	1 st. Veerring M10	1 st. Ring M10 (groot)
			

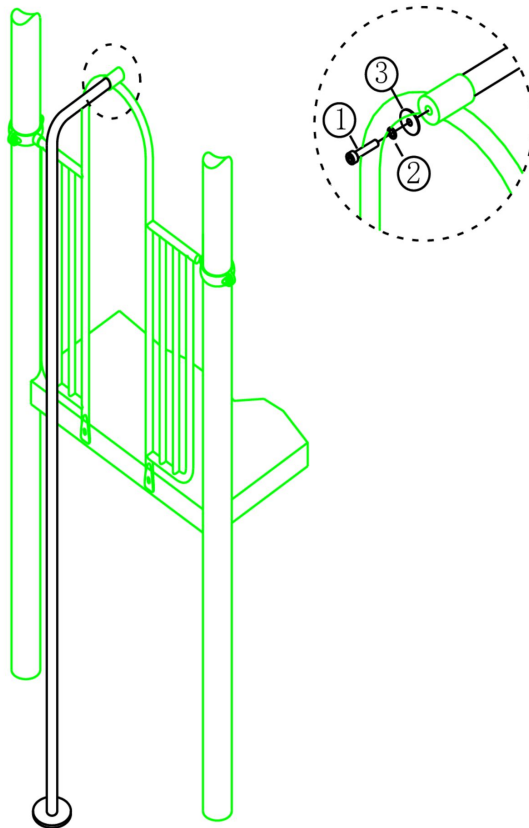





Bevestigings materiaal is per zakje verpakt en bovenstaande afbeelding zit in het zakje

Hekje tbv: B, Pod en Curly Climber

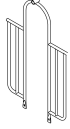
STAP 1 van 1

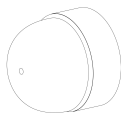
Omschrijving: Bevestiging van het hek tussen de vloer/staander

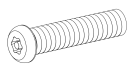
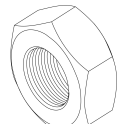
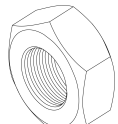
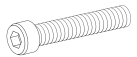
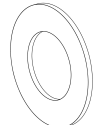
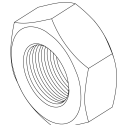
1 st. Hekje tbv: B, Pod en Curly Climber	2 st. Small clamp + ring	2 st. Afdekdop M10	2 st. Kruiskop M6X65
			① 
4 st. Torx M8X20	4 st. Lock Moer M8	2 st. Lock Moer M6	2 st. Bout M10X25
② 	③ 	④ 	⑤ 
4 st. Ring M10 (middel)	2 st. Lock Moer M10		
⑥ 	⑦ 		

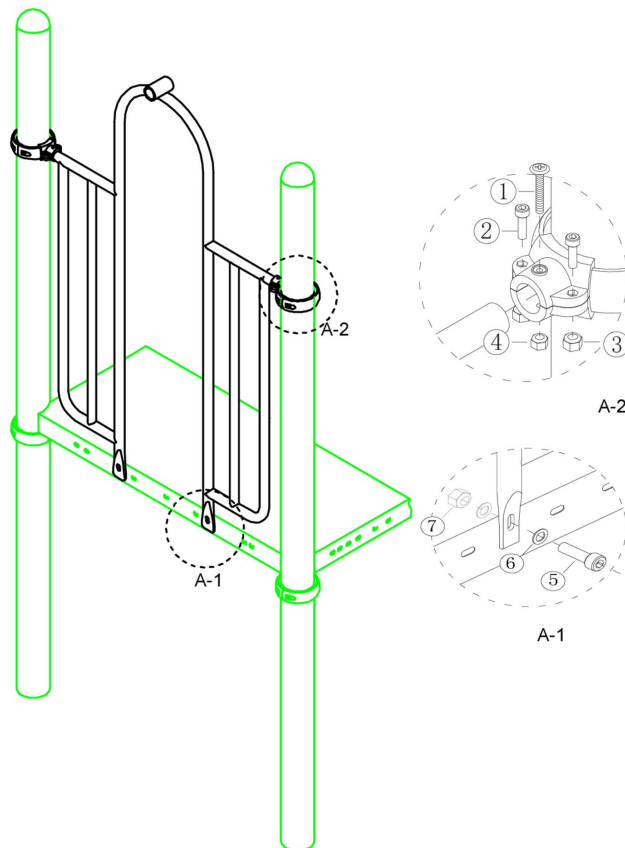

Bevestigings materiaal is per zakje verpakt en bovenstaande afbeelding zit in het zakje

90cm Pod climber

Hoofdafmetingen: 304x71cm

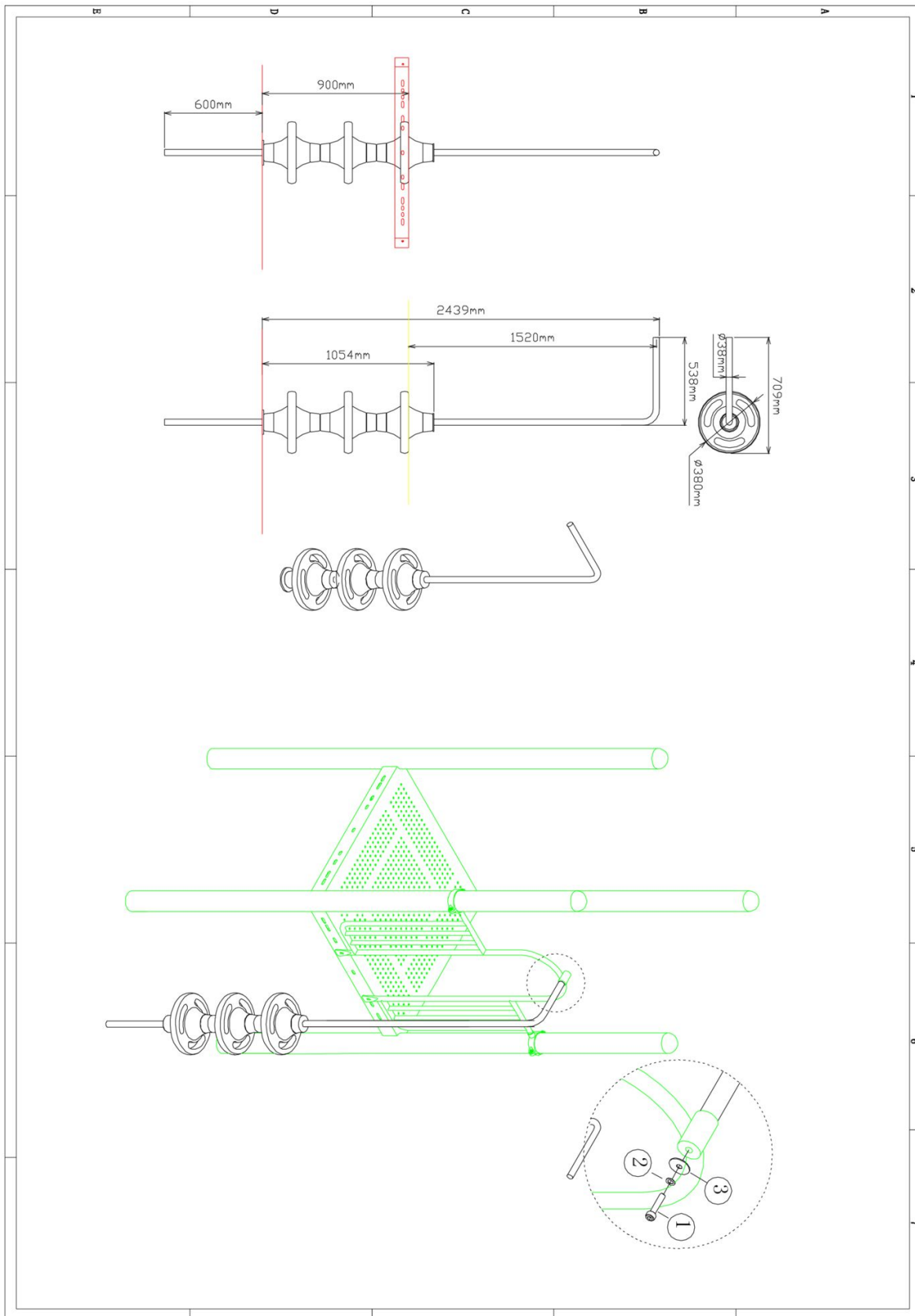

90cm Pod climber

STAP 1 van 1

Omschrijving: Bevestiging tussen hek en pod climber

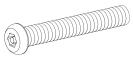
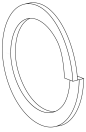
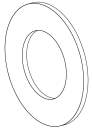
1 st. 90cm Pod climber	1 st. Torx M10X30	1 st. Veerring M10	1 st. Ring M10 (middel)
			

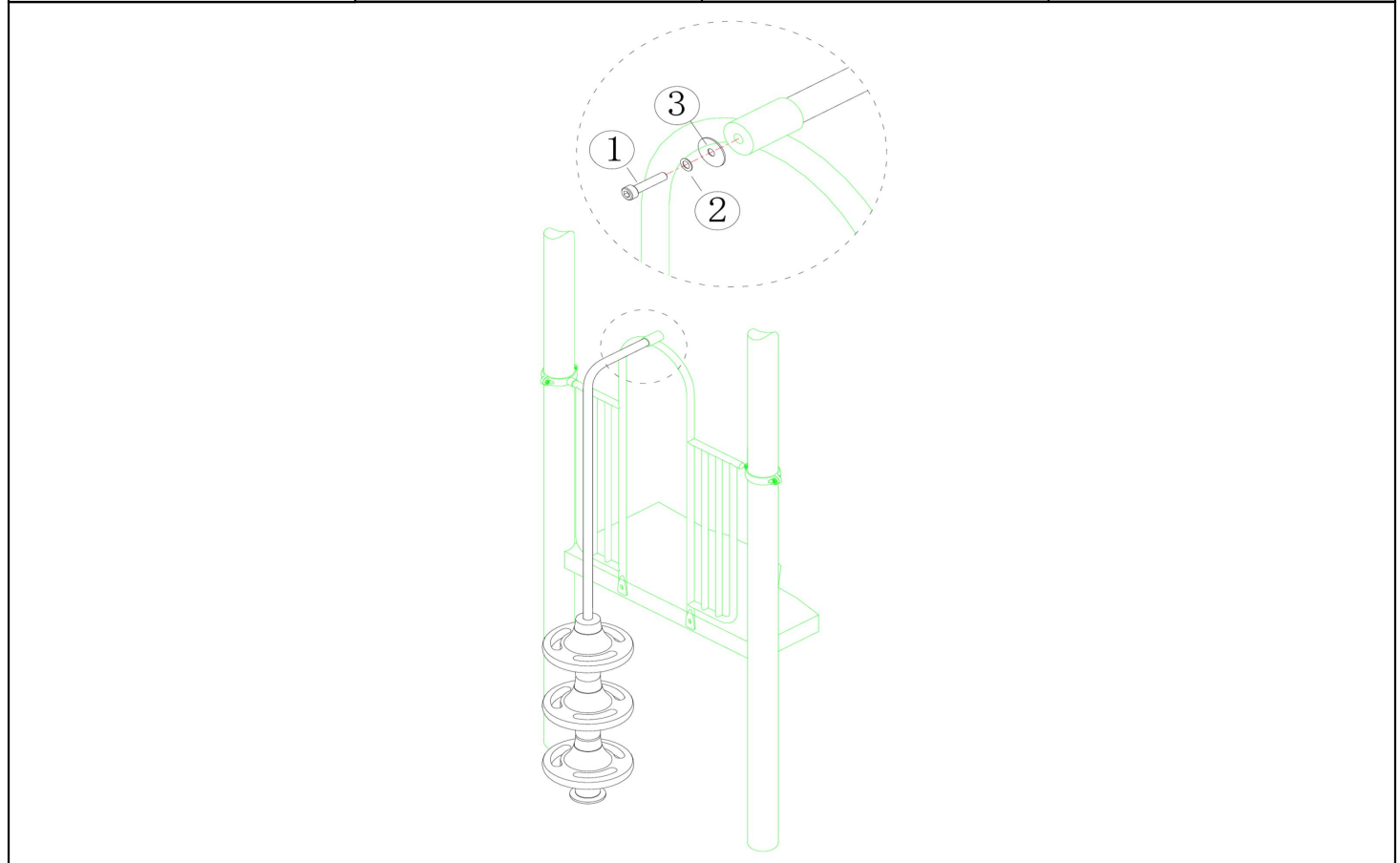

Bevestigings materiaal is per zakje verpakt en bovenstaande afbeelding zit in het zakje

Hekje tbv Snake climber



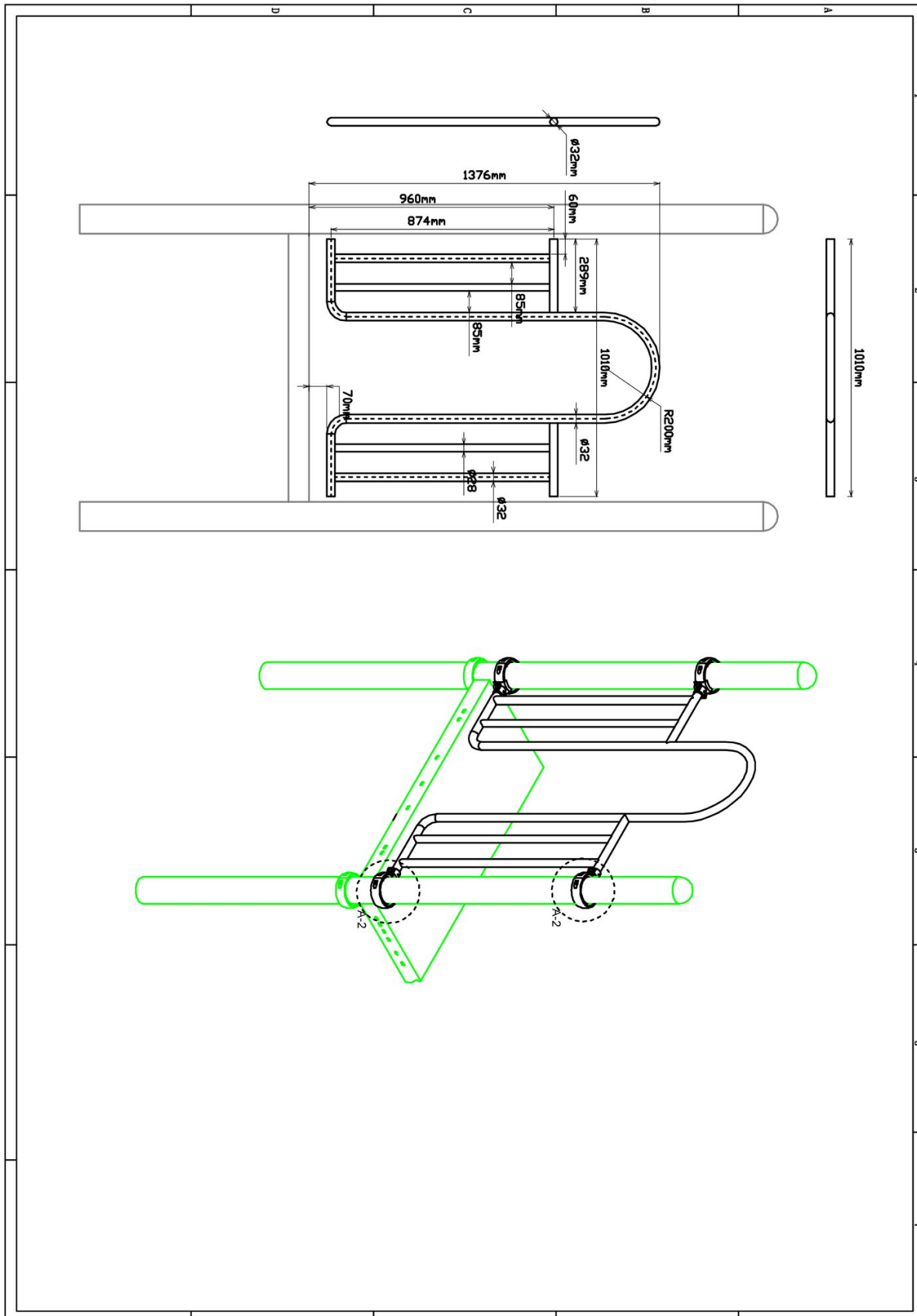

Hoofdafmetingen: 138x101cm

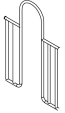

Hekje tbv Snake climber

STAP 1 van 1

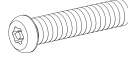
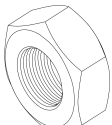
Omschrijving: Bevestiging van het paneel tussen de staanders

1 st. Hekje tbv Snake climber	4 st. Small clamp + ring	4 st. Kruiskop M6X65	8 st. Torx M8X20
		1 	2 
8 st. Lock Moer M8	4 st. Lock Moer M6		
3 	4 		

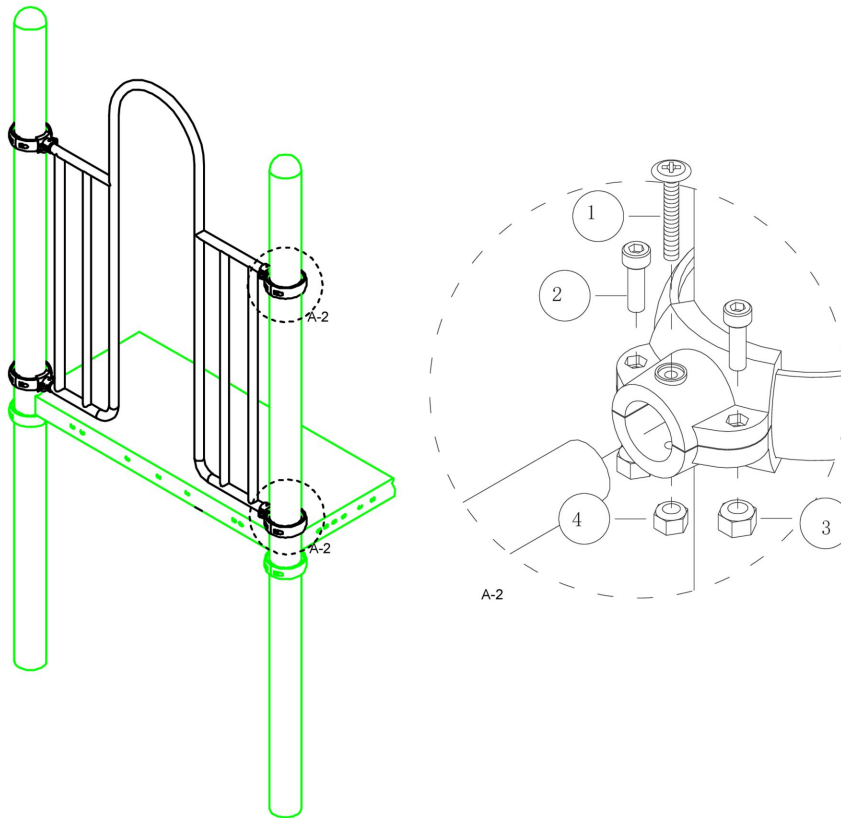

Bevestigings materiaal is per zakje verpakt en bovenstaande afbeelding zit in het zakje

150cm Snake climber

Hoofdafmetingen: 209x67cm

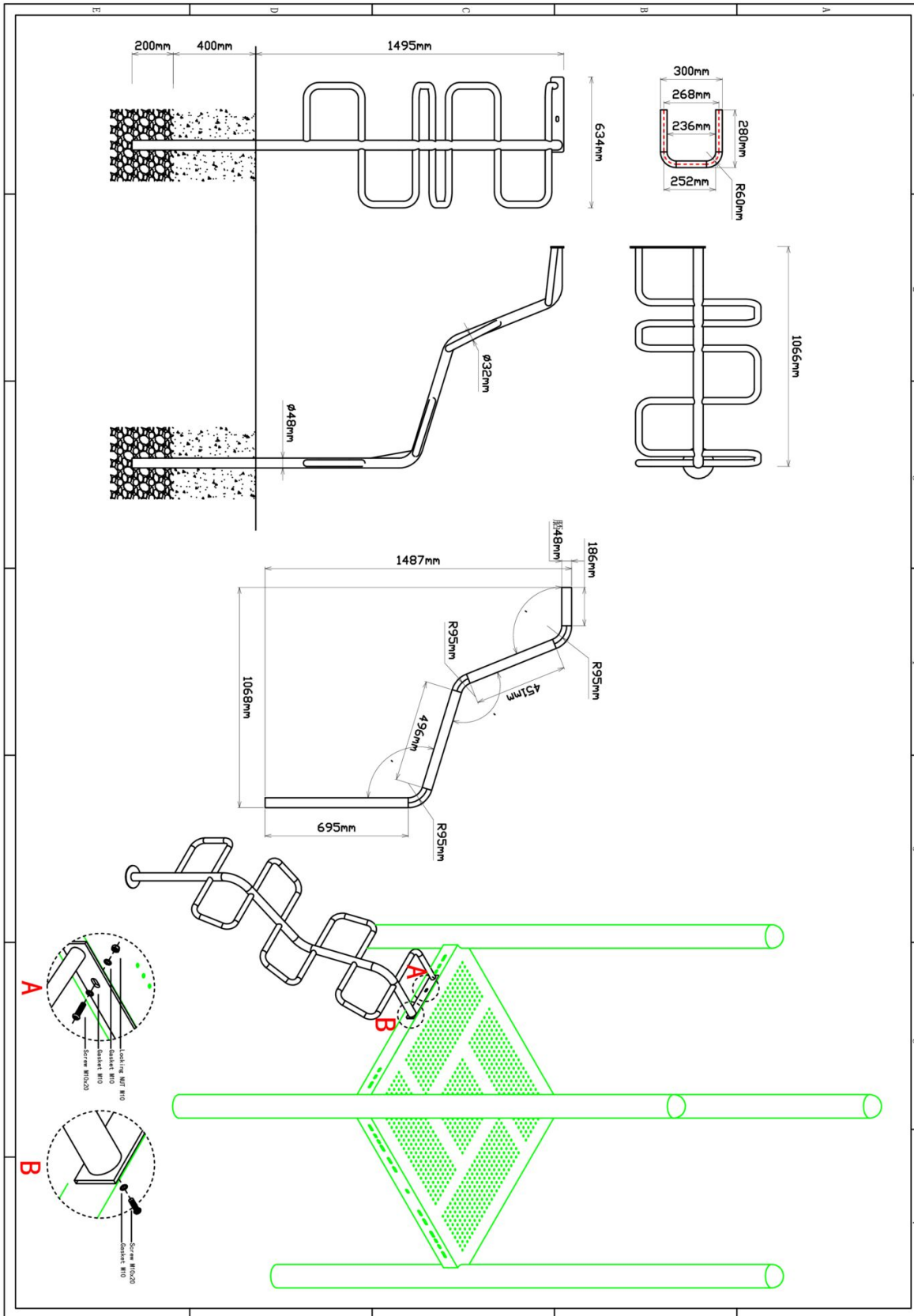

150cm Snake climber

STAP 1 van 1

Omschrijving: Bevestiging tussen snake climber en de vloer

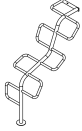
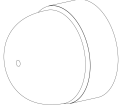
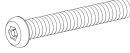
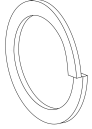
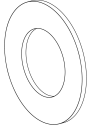
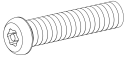
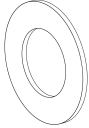
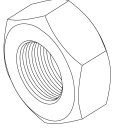
1 st. 150cm Snake climber	1 st. Afdekdop M10	1 st. Torx M10X30	1 st. Veerring M10
		1 	2 
1 st. Ring M10 (middel)	1 st. Torx M10X20	2 st. Ring M10 (middel)	1 st. Lock Moer M10
3 	4 	5 	6 

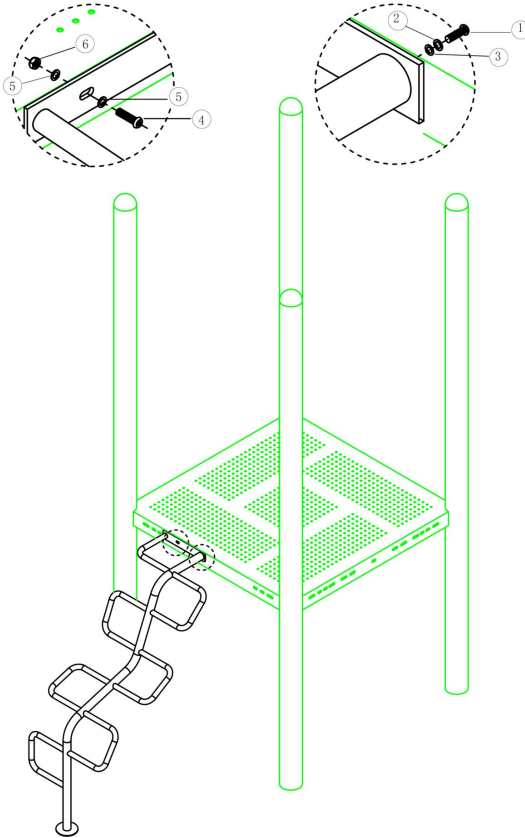





Bevestigings materiaal is per zakje verpakt en bovenstaande afbeelding zit in het zakje

Hek Driehoeksvloer met bevestiging

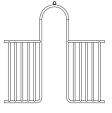
STAP 1 van 1

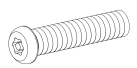
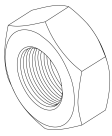
Omschrijving: Bevestiging van het hek tussen de vloer/staander

1 st. Hek Driehoeksvloer met bevestiging	4 st. Small clamp + ring	4 st. Kruiskop M6X65	8 st. Torx M8X20
			
8 st. Lock Moer M8	4 st. Lock Moer M6		
			

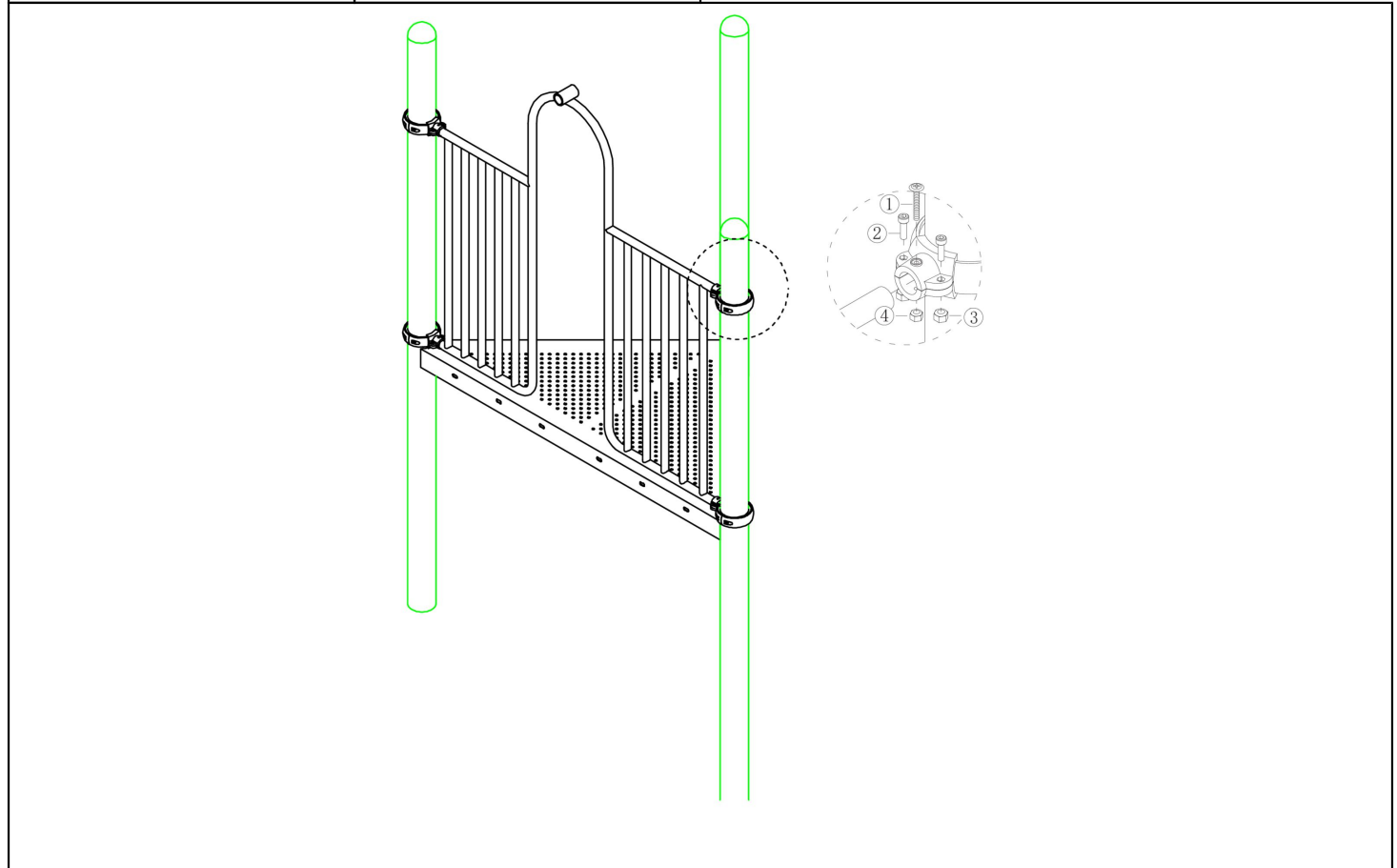

Bevestigings materiaal is per zakje verpakt en bovenstaande afbeelding zit in het zakje

150cm Glijstang

Hoofdafmetingen: 362x42cm

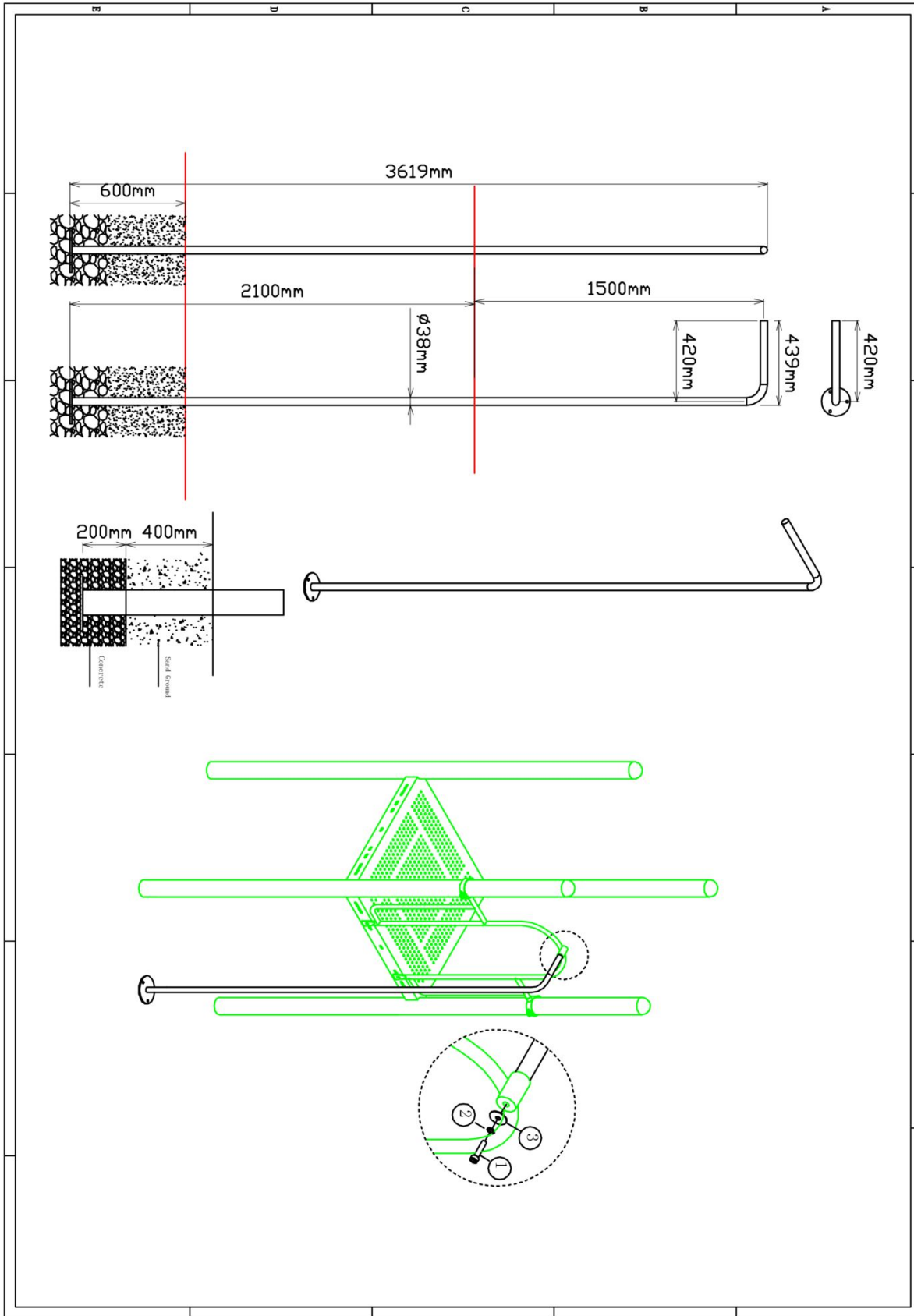

150cm Glijstang

STAP 1 van 1

Omschrijving: Bevestiging tussen de glijstang en het hek

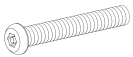
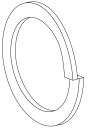
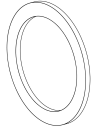
1 st. 150cm Glijstang	1 st. Torx M10X30	1 st. Veerring M10	1 st. Ring M10 (groot)
			

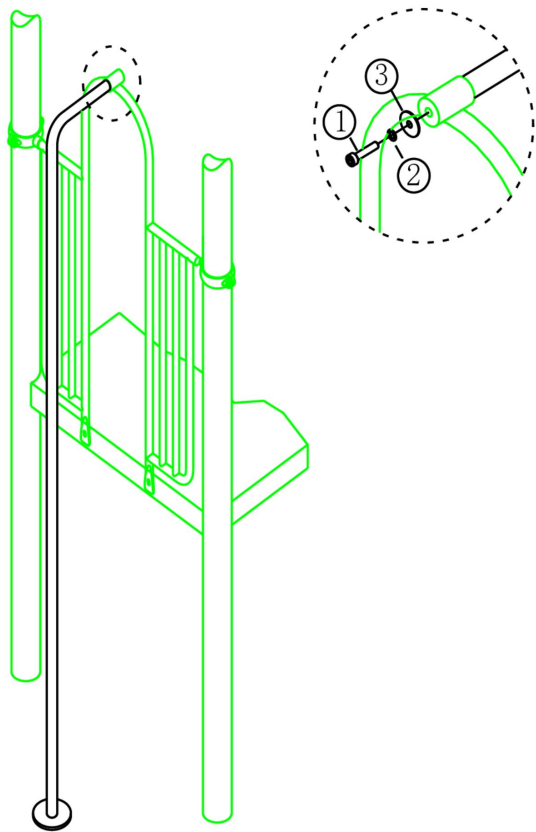

Bevestigings materiaal is per zakje verpakt en bovenstaande afbeelding zit in het zakje

Kruipbuis paneel



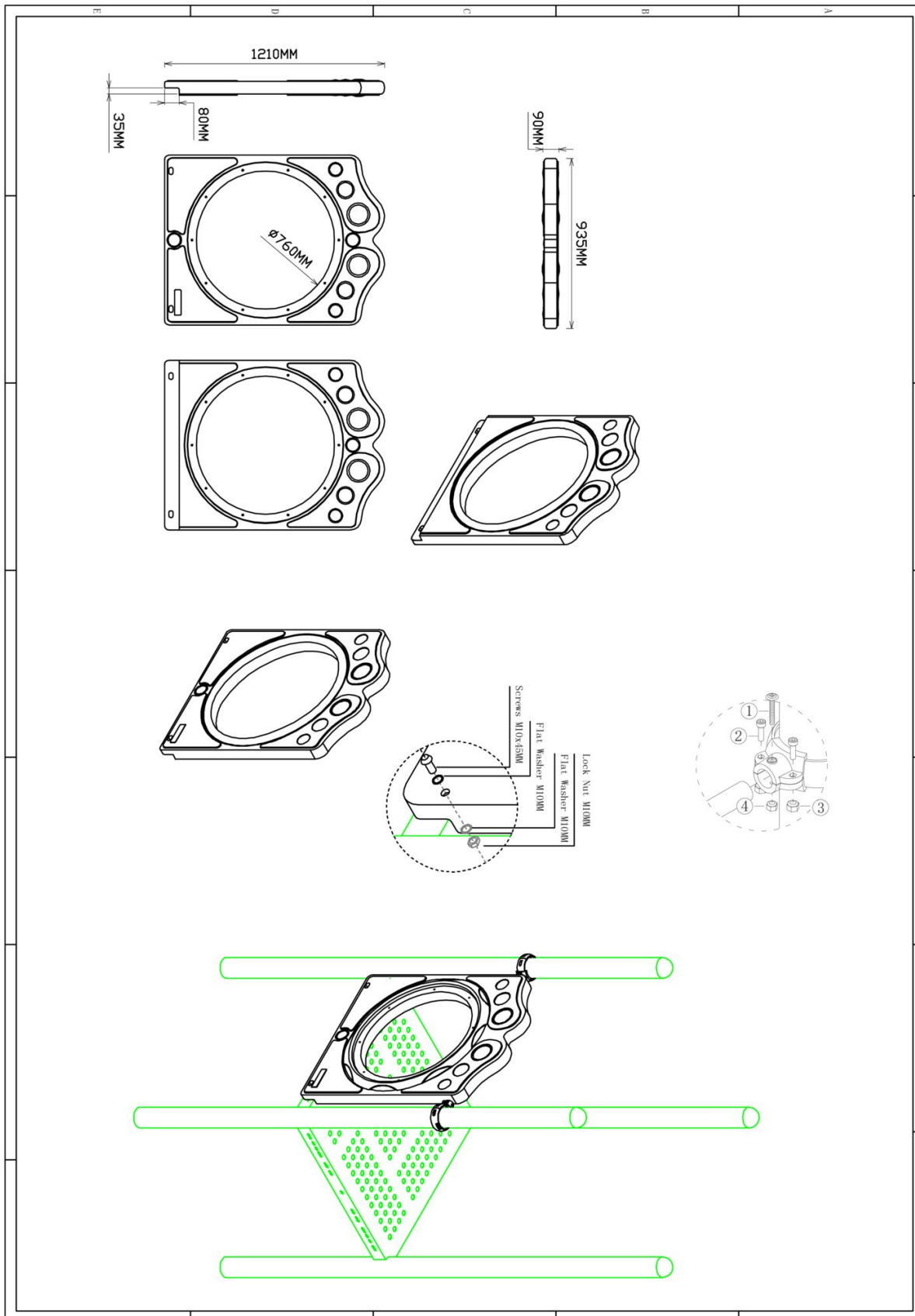



Hoofdafmetingen: 121x94cm

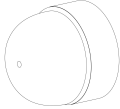

Kruipbuis paneel

STAP 1 van 1

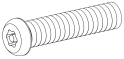
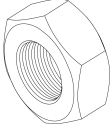
Omschrijving: Bevestiging tussen vloer/staander en kruipbuis-paneel

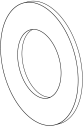
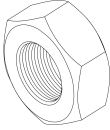
1 st. Kruipbuis paneel	2 st. Small clamp + ring	2 st. Afdekdop M10	2 st. Kruiskop M6X65
			① 
4 st. Torx M8X20	4 st. Lock Moer M8	2 st. Lock Moer M6	2 st. Torx M10X50
② 	③ 	④ 	⑤ 
4 st. Ring M10 (middel)	2 st. Lock Moer M10		
⑥ 	⑦ 		

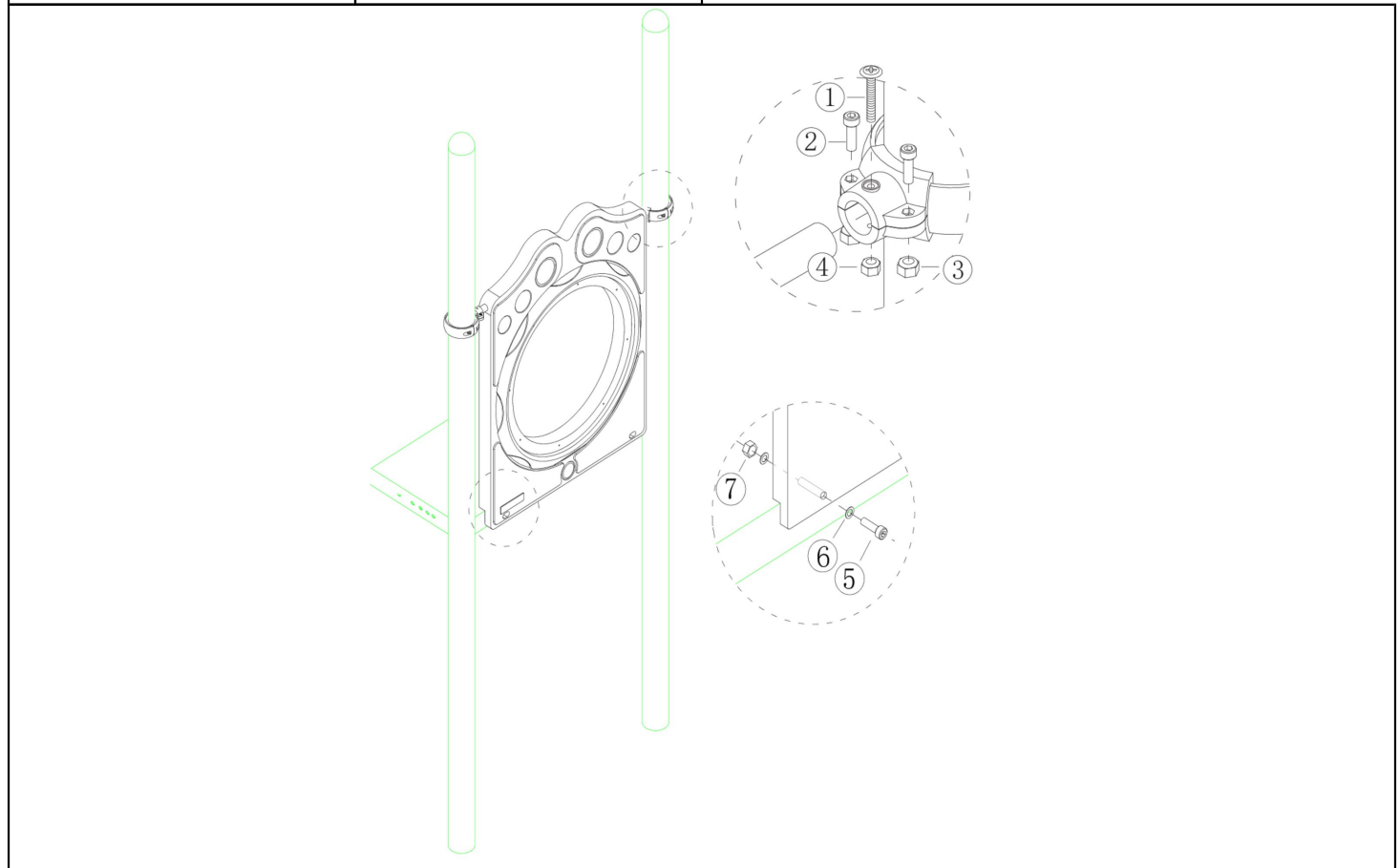

Bevestigings materiaal is per zakje verpakt en bovenstaande afbeelding zit in het zakje

Tube glijbaan 60cm deel recht

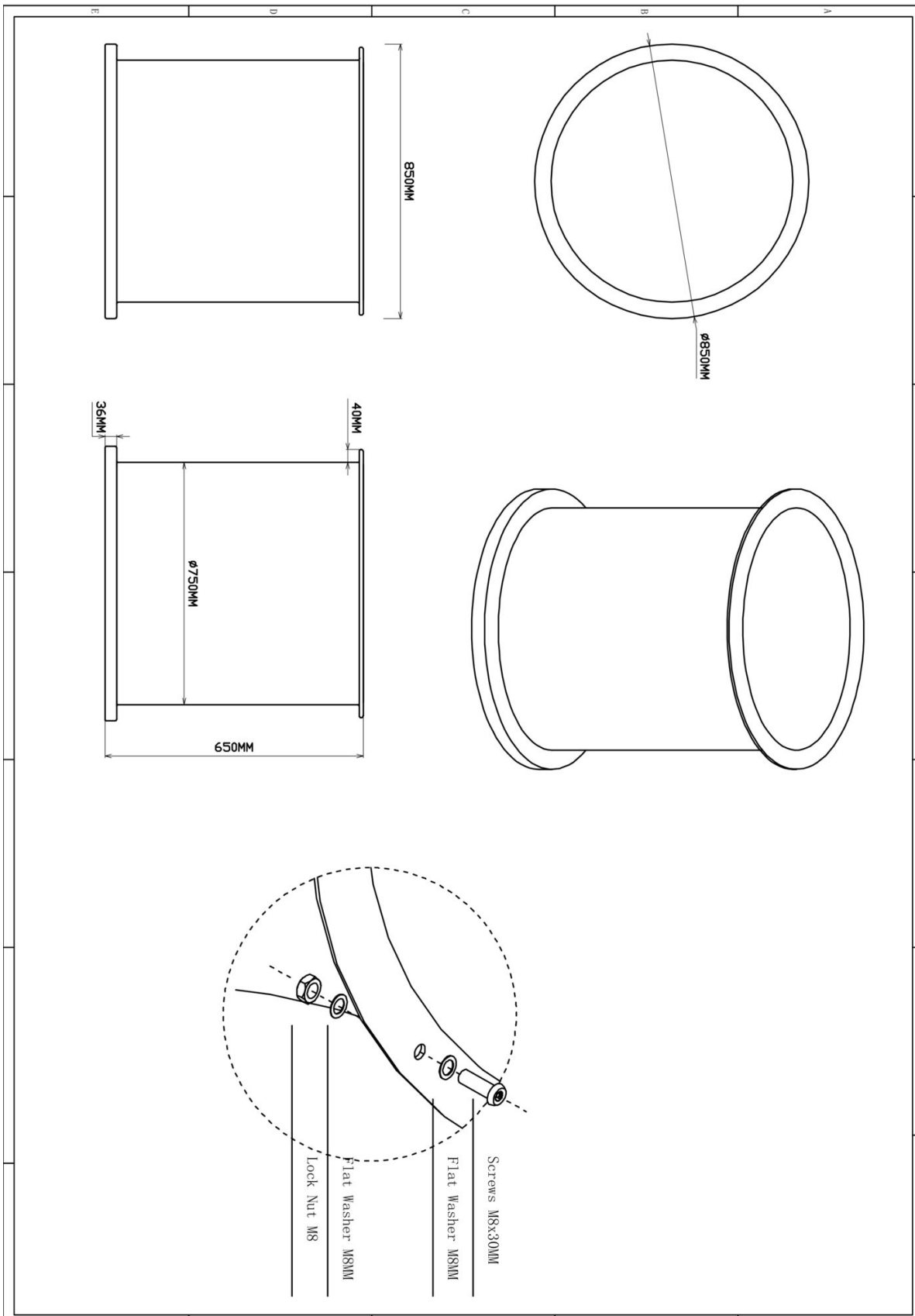

Hoofdafmetingen: $\varnothing 85 \times 60$ cm



Tube glijbaan 60cm deel recht

STAP 1 van 1

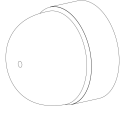
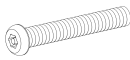
Omschrijving: Bevestiging tussen de buizen

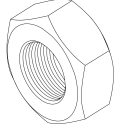
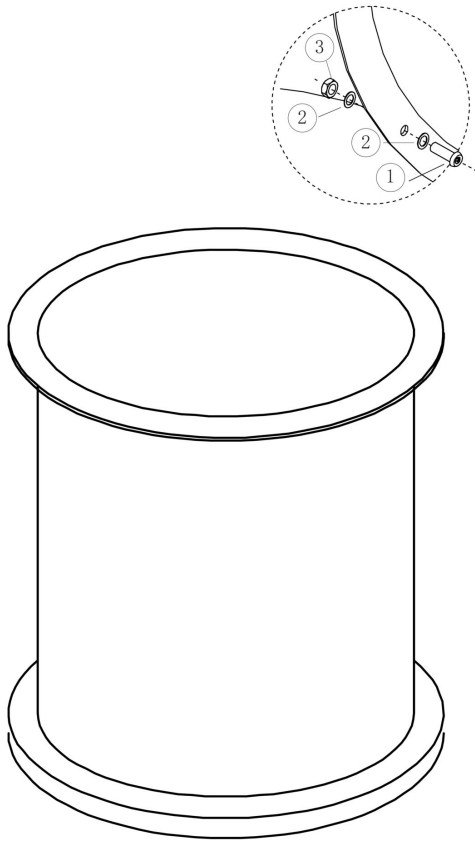
10 st. Afdekdop M8	10 st. Torx M8X30	20 st. Ring M8 (klein)	10 st. Lock Moer M8
	<p>1</p> 	<p>2</p> 	<p>3</p> 
			
<p>Bevestigings materiaal is per zakje verpakt en bovenstaande afbeelding zit in het zakje</p>			

Tube glijbaan 60cm deel recht (transparant)

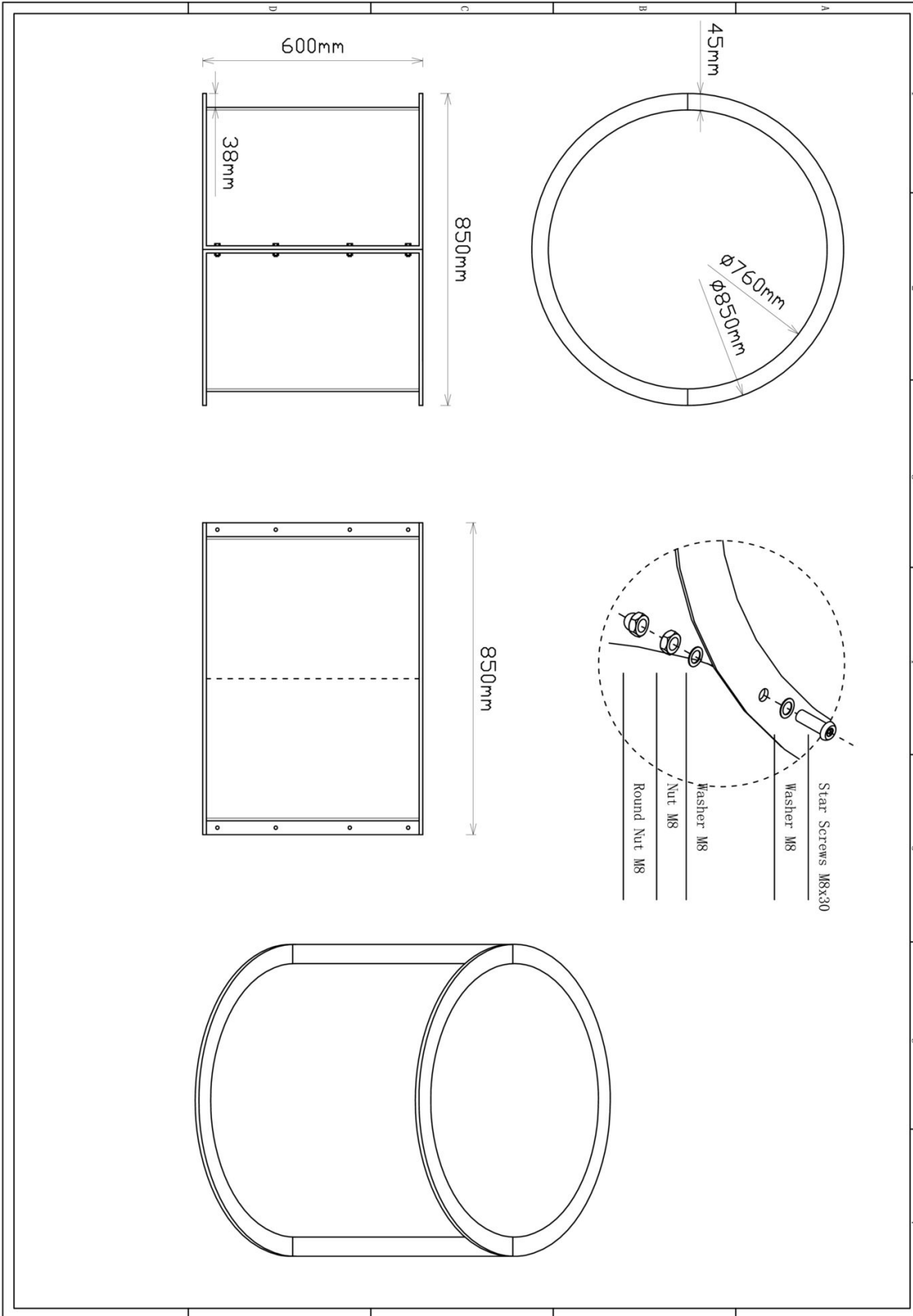

Hoofdafmetingen: Ø85x60 cm



Tube glijbaan 60cm deel recht (transparant)

STAP 1 van 1

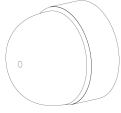
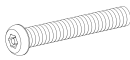
Omschrijving: Bevestiging tussen de buizen

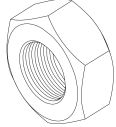
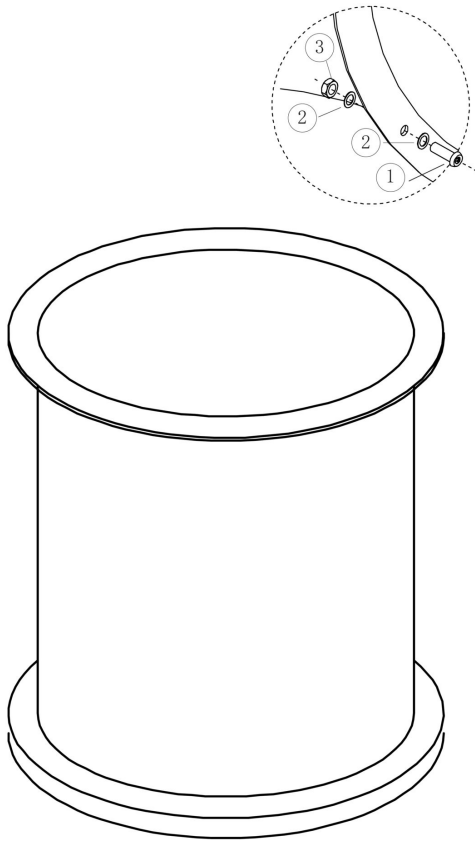
10 st. Afdekdop M8	10 st. Torx M8X30	20 st. Ring M8 (klein)	10 st. Lock Moer M8
	<p>1</p> 	<p>2</p> 	<p>3</p> 
			
<p>Bevestigings materiaal is per zakje verpakt en bovenstaande afbeelding zit in het zakje</p>			

Tube glijbaan 30 graden bocht

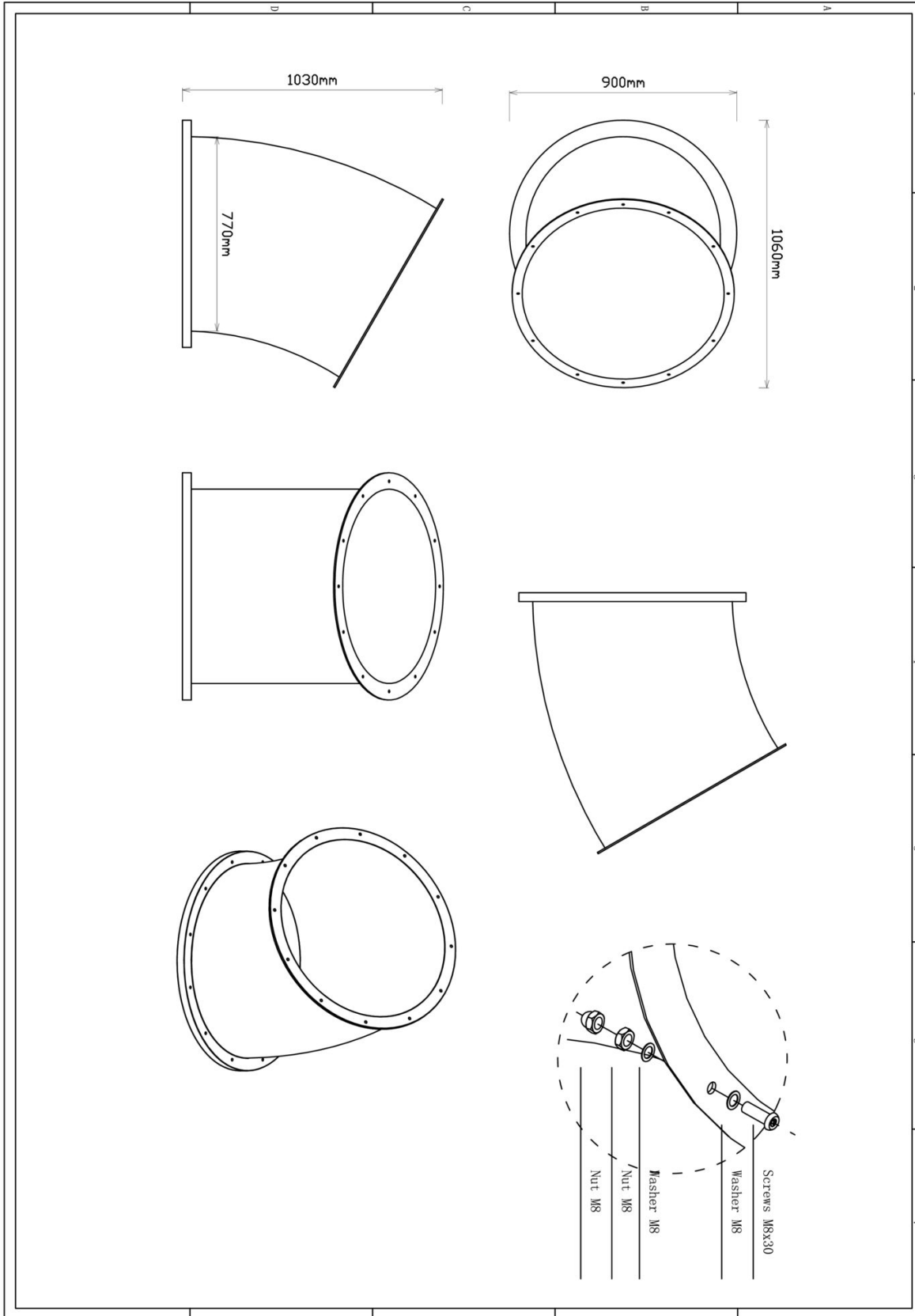

Hoofdafmetingen: 106x103x90 cm



Tube glijbaan 30 graden bocht

STAP 1 van 1

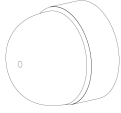
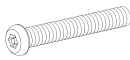
Omschrijving: Bevestiging tussen de tube buizen.

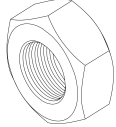
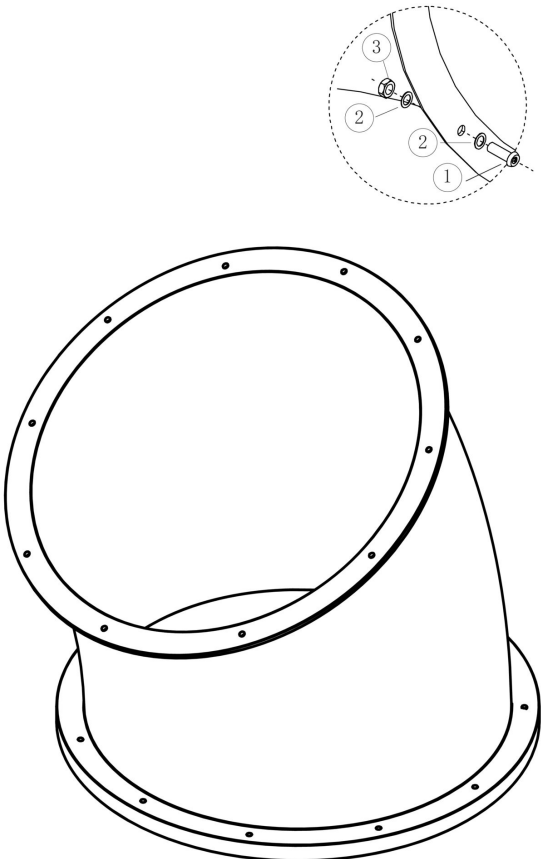
10 st. Afdekdop M8	10 st. Torx M8X30	20 st. Ring M8 (klein)	10 st. Lock Moer M8
	<p>1</p> 	<p>2</p> 	<p>3</p> 
			
<p>Bevestigings materiaal is per zakje verpakt en bovenstaande afbeelding zit in het zakje</p>			

Tube glijbaan exit

Hoofdafmetingen: 165x106x92 cm

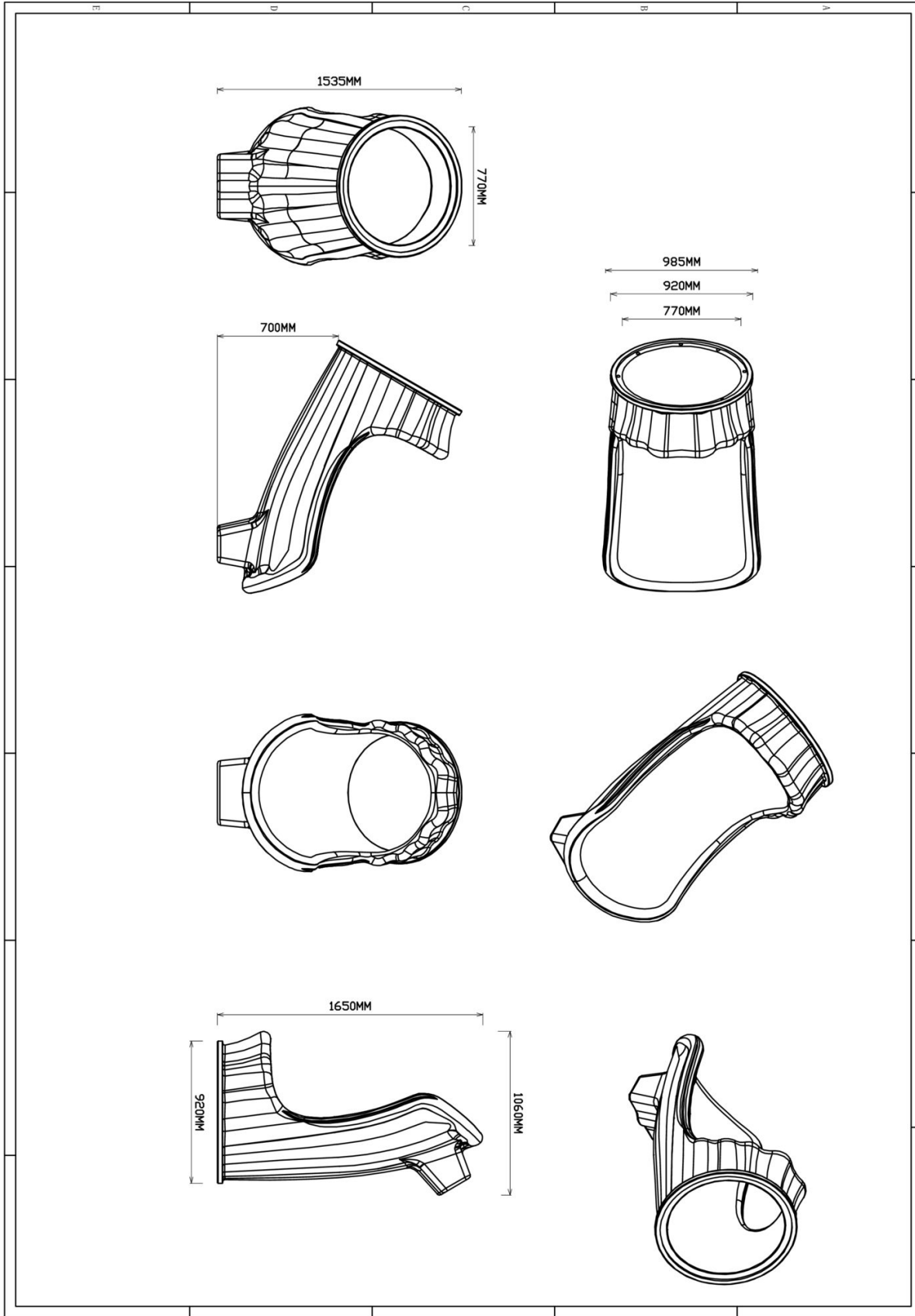

Tube glijbaan exit

STAP 1 van 1

Omschrijving: Bevestiging tussen tube buizen.

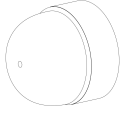
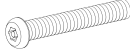
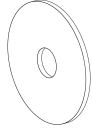
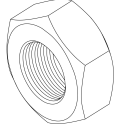
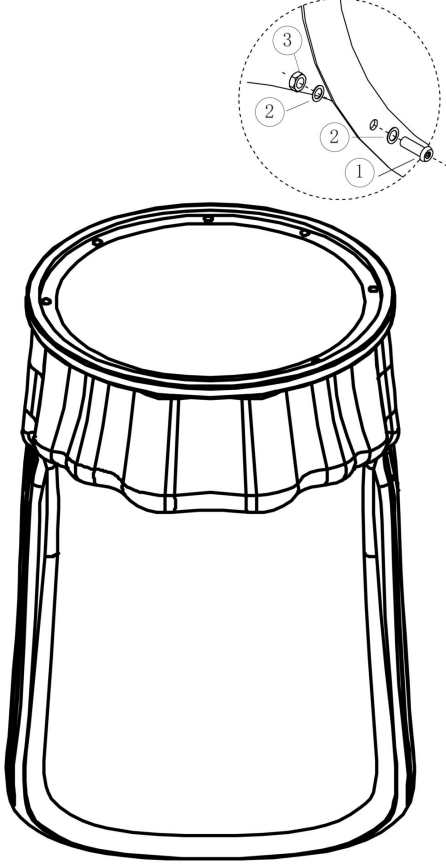
8 st. Afdekdop M8	8 st. Torx M8X30	16 st. Ring M8 (klein)	8 st. Lock Moer M8
	<p>1</p> 	<p>2</p> 	<p>3</p> 
			
<p>Bevestigings materiaal is per zakje verpakt en bovenstaande afbeelding zit in het zakje</p>			

Tube glijbaanvoet 131cm

Hoofdafmetingen: 205x89x18cm

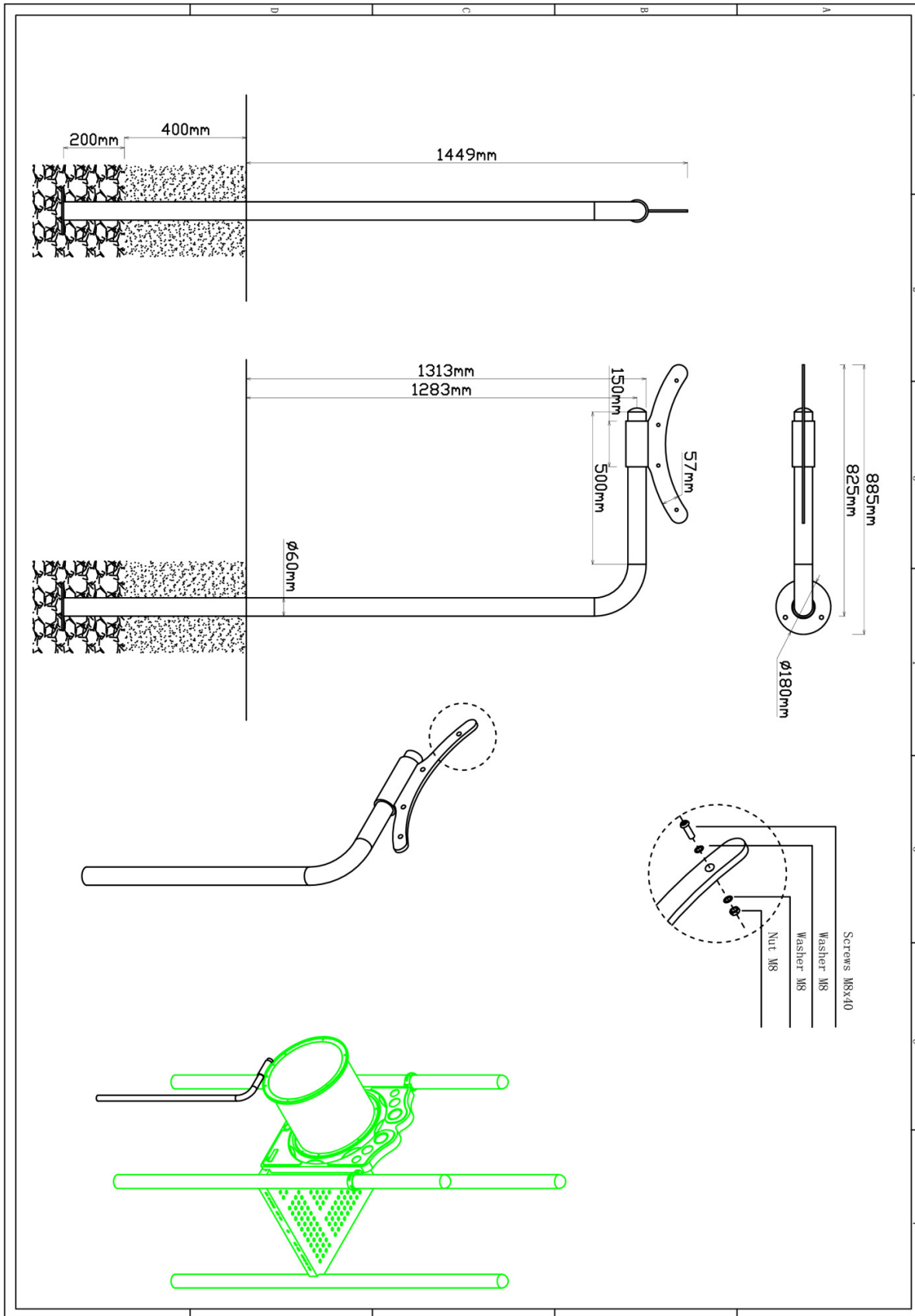

Tube glijbaanvoet 131cm

STAP 1 van 1

Omschrijving: Bevestiging tussen de glijbaanvoet en de tubeglijbaan

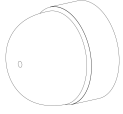
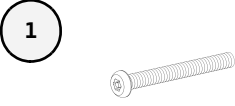
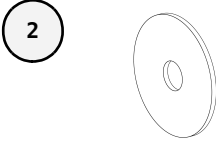
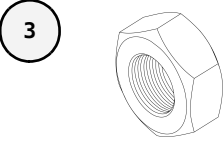
4 st. Afdekdop M8	4 st. Torx M8X40	8 st. Ring M8 (klein)	4 st. Lock Moer M8
			

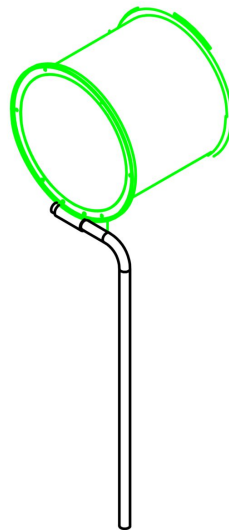
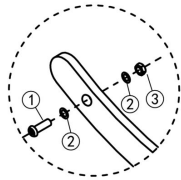

Bevestigings materiaal is per zakje verpakt en bovenstaande afbeelding zit in het zakje

Dubbele voet tube glijbaan

Hoofdafmetingen: 110x70x5 cm

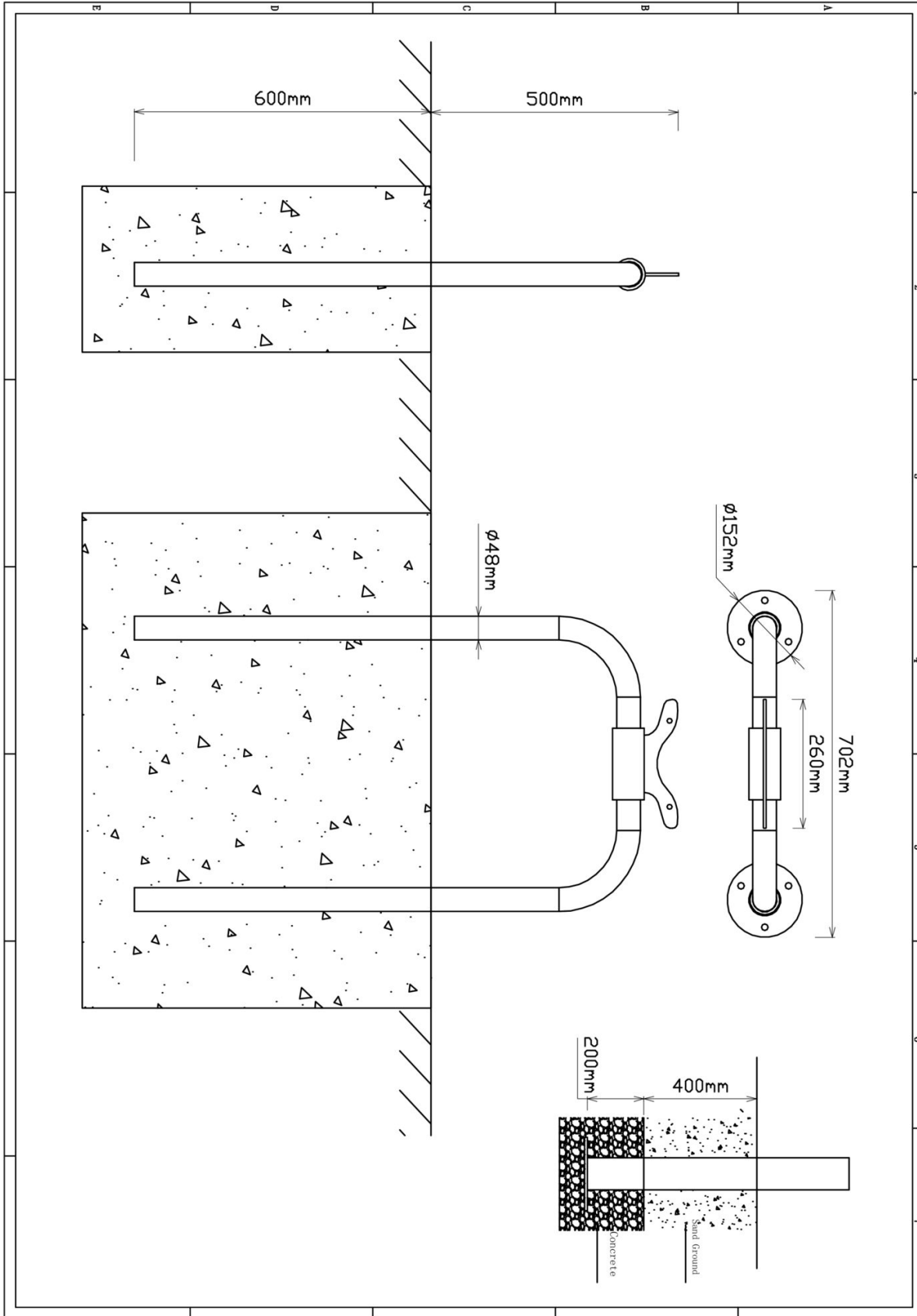

Dubbele voet tube glijbaan

STAP 1 van 1

Omschrijving: Bevestiging tussen de dubbele voet en tube glijbaan

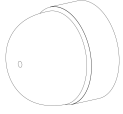
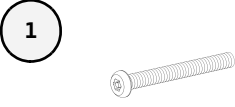
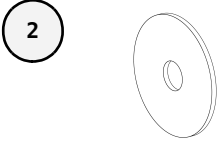
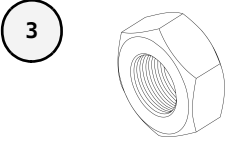
4 st. Afdekdop M8	4 st. Torx M8X40	8 st. Ring M8 (klein)	4 st. Lock Moer M8
			

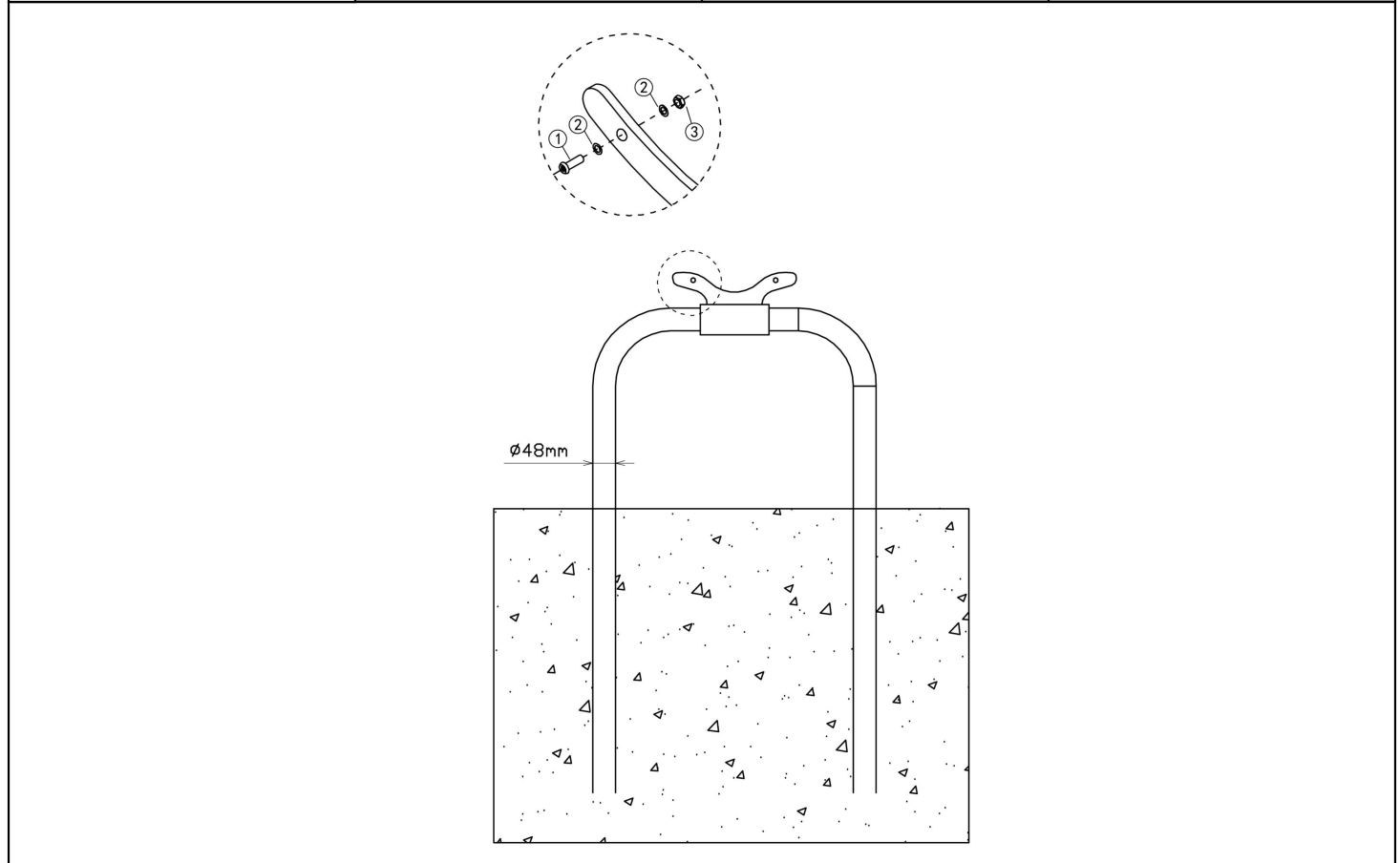

Bevestigings materiaal is per zakje verpakt en bovenstaande afbeelding zit in het zakje

Tube glijbaanvoet voorkant

Hoofdafmetingen: 30x15cm

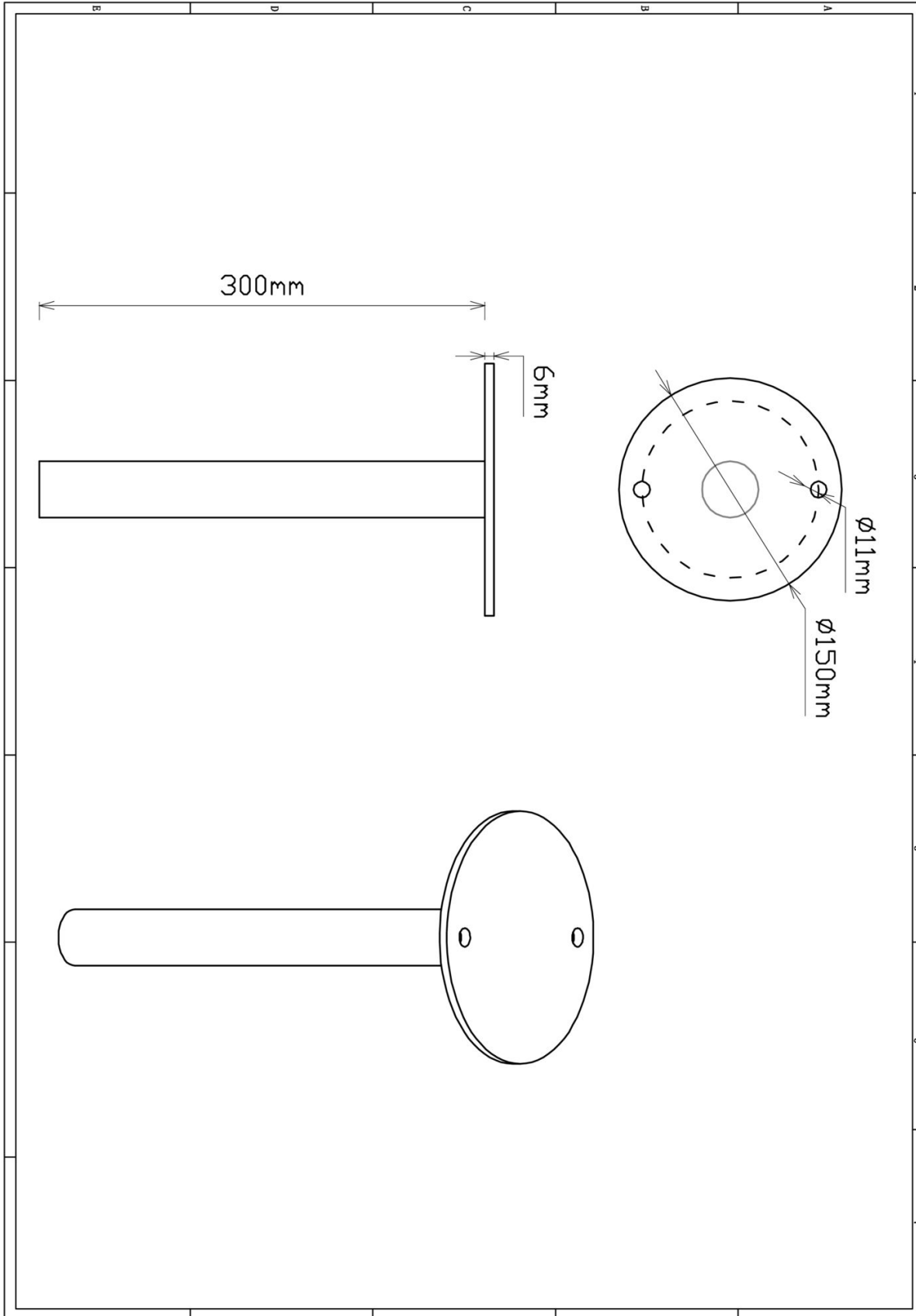

Tube-glijbaanvoet voorkant

STAP 1 van 1

Omschrijving: Bevestiging van de voet onder de tube-glijbaan

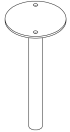
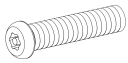
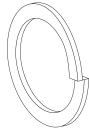
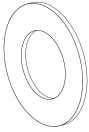
1 st. Glijbaanvoet voorkant	2 st. Torx M8X20	2 st. Veerring M8	2 st. Ring M8 (middel)
	<p>1</p> 	<p>2</p> 	<p>3</p> 

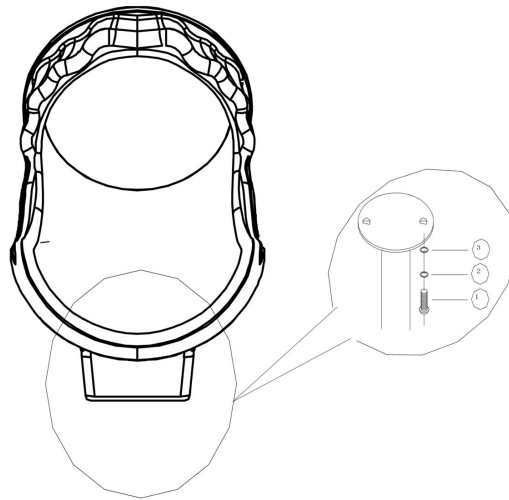

Bevestigings materiaal is per zakje verpakt en bovenstaande afbeelding zit in het zakje

PE Plaat tube-glijbaan

Hoofdafmetingen: 93x77x2cm

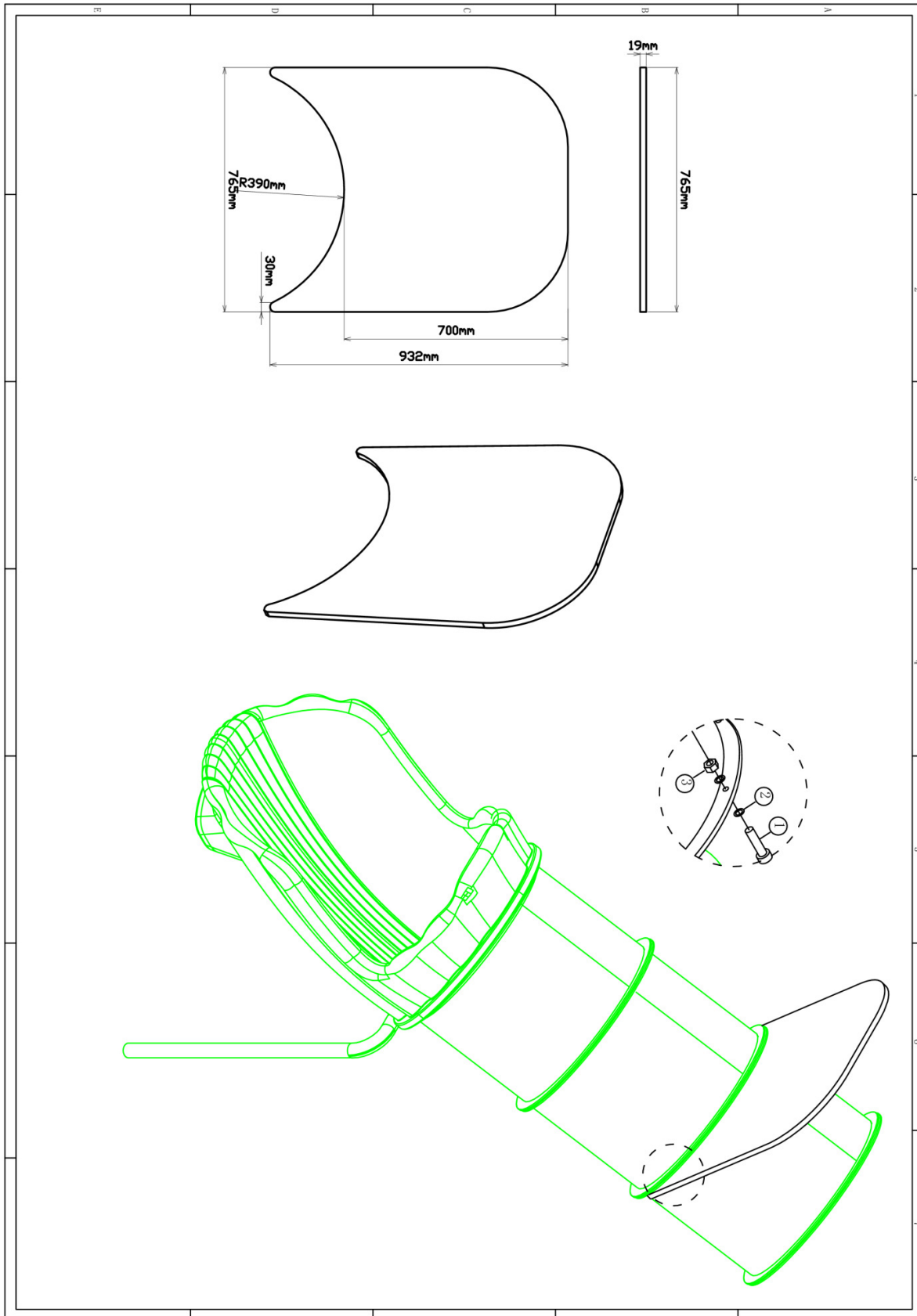

PE Plaat tubeglijbaan

STAP 1 van 1

Omschrijving: Bevestiging tussen de plaat en de tube glijbaan

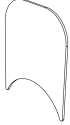
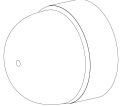
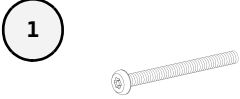
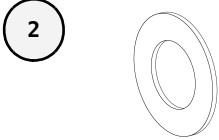
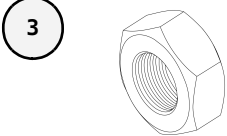
1 st. PE Plaat tubeglijbaan	5 st. Afdekdop M8	5 st. Torx M8X50	10 st. Ring M8 (middel)
			
5 st. Lock Moer M8			
			

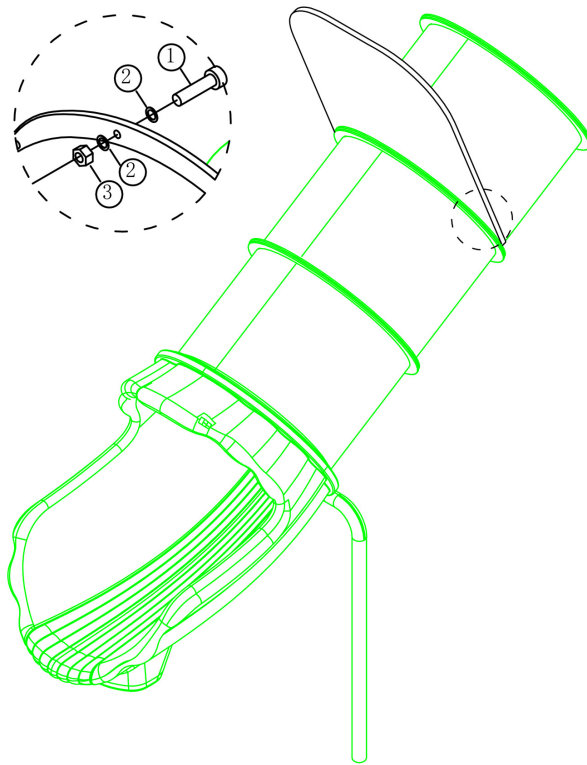

Bevestigings materiaal is per zakje verpakt en bovenstaande afbeelding zit in het zakje

Zeskant dak met panelen

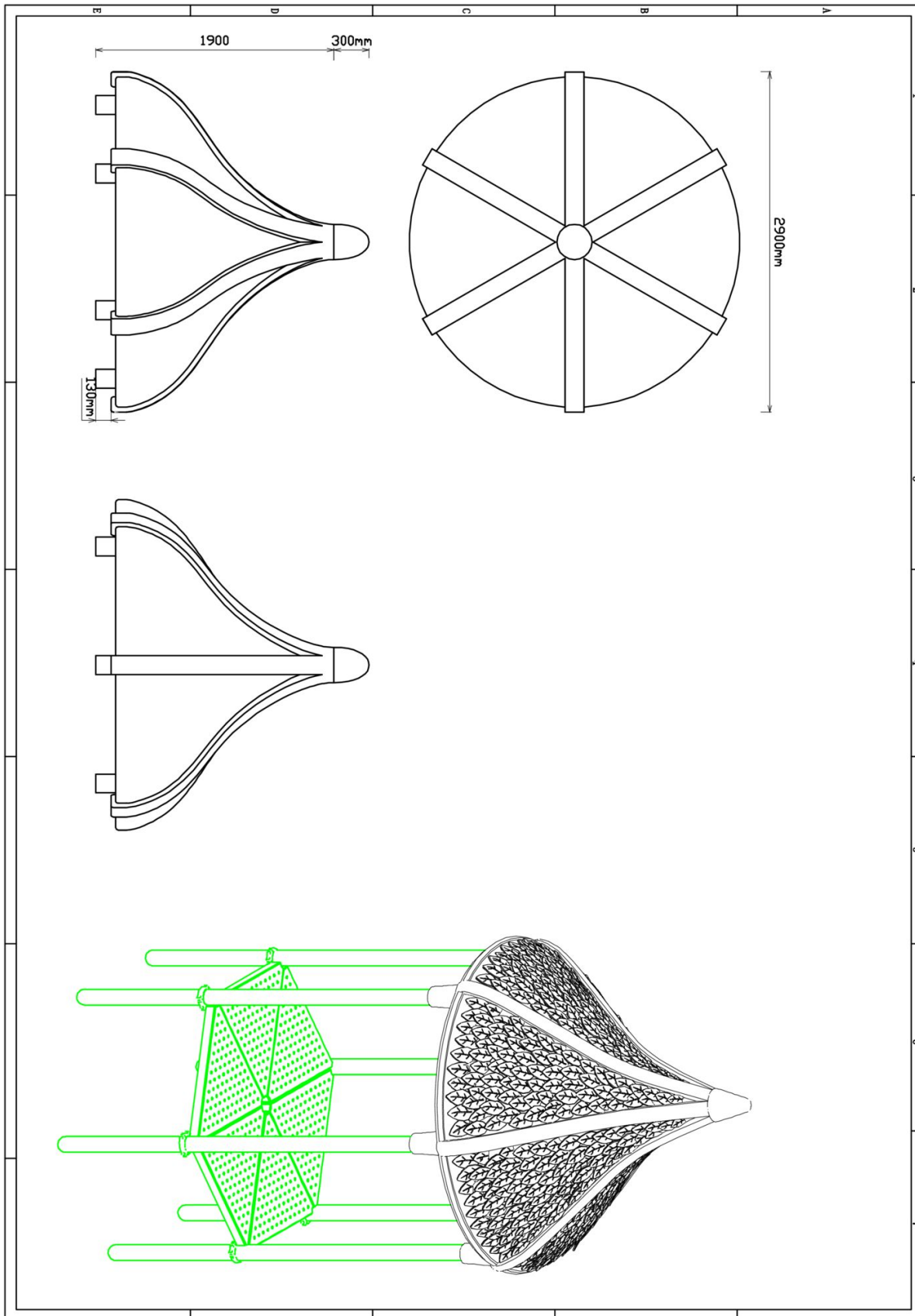

Hoofdafmetingen: 290x290x120cm



Zeskant dak met panelen

STAP 1 van 3

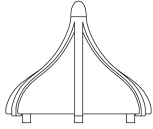
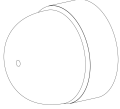
Omschrijving: Bevestiging tussen de dakdelen

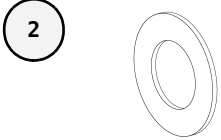
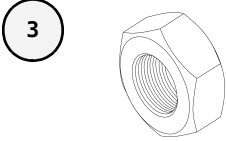
1 st. Zeskant dak met panelen	18 st. Afdekdop M8	18 st. Torx M8X120	36 st. Ring M8 (middel)
			
18 st. Lock Moer M8			
			

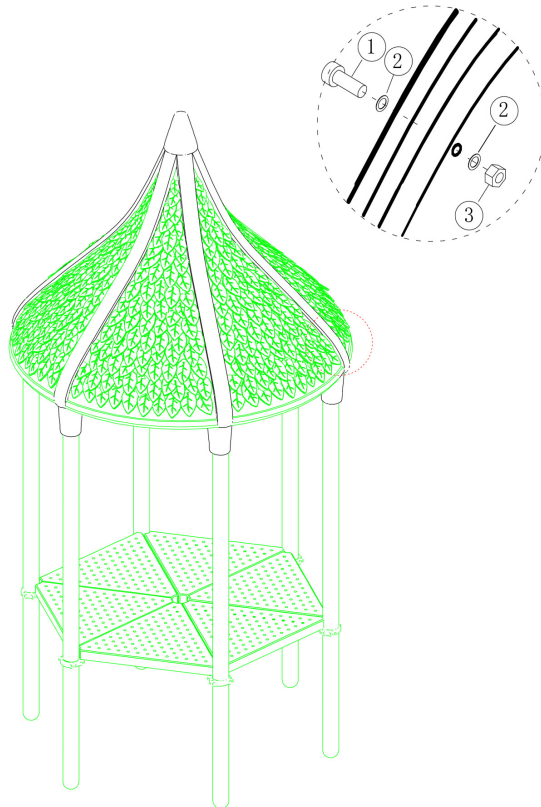

Bevestigings materiaal is per zakje verpakt en bovenstaande afbeelding zit in het zakje

Zeskant dak met panelen

STAP 2 van 3

Omschrijving: Bevestiging tussen het dak en de nok

4 st. Kruiskop M4x50
Zelftap

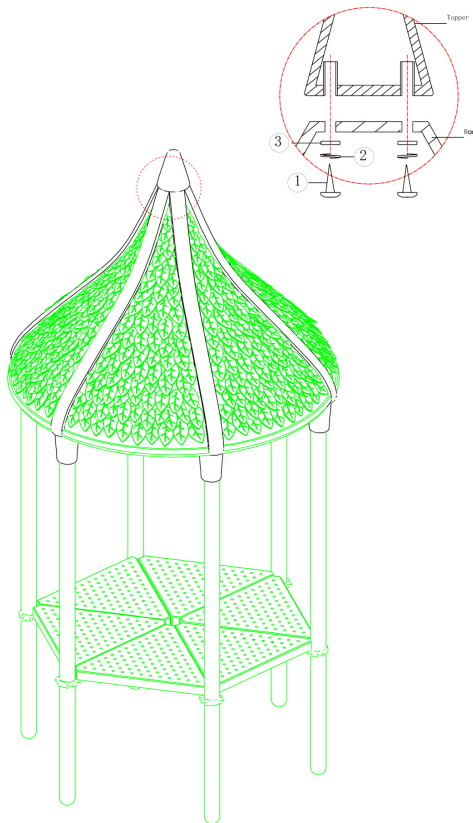
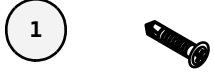



Bevestigings materiaal is per zakje verpakt en bovenstaande afbeelding zit in het zakje

Zeskant dak met panelen

STAP 3 van 3

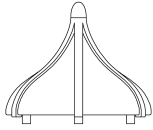
Omschrijving: Bevestiging van het dak op de standers

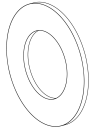
<p>1 st. Zeskant dak met panelen</p>	<p>12 st. Kruiskop M4x50 Zelftap</p>
	<p>1</p> 
<p>12 st. Ring M6 (middel)</p>	
<p>2</p> 	

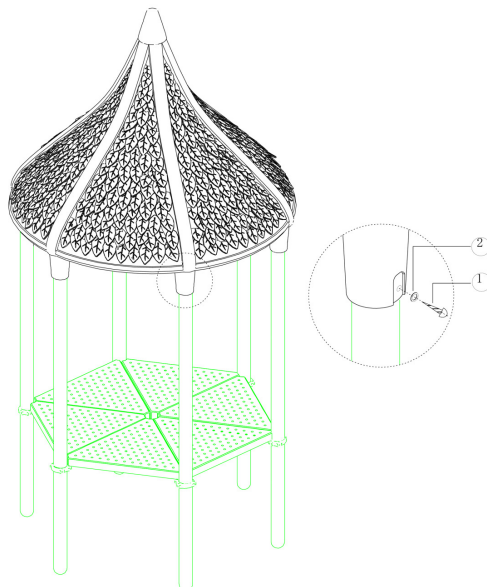

Bevestigings materiaal is per zakje verpakt en bovenstaande afbeelding zit in het zakje

Bankje 2.0

Hoofdafmetingen: 116x22x4cm

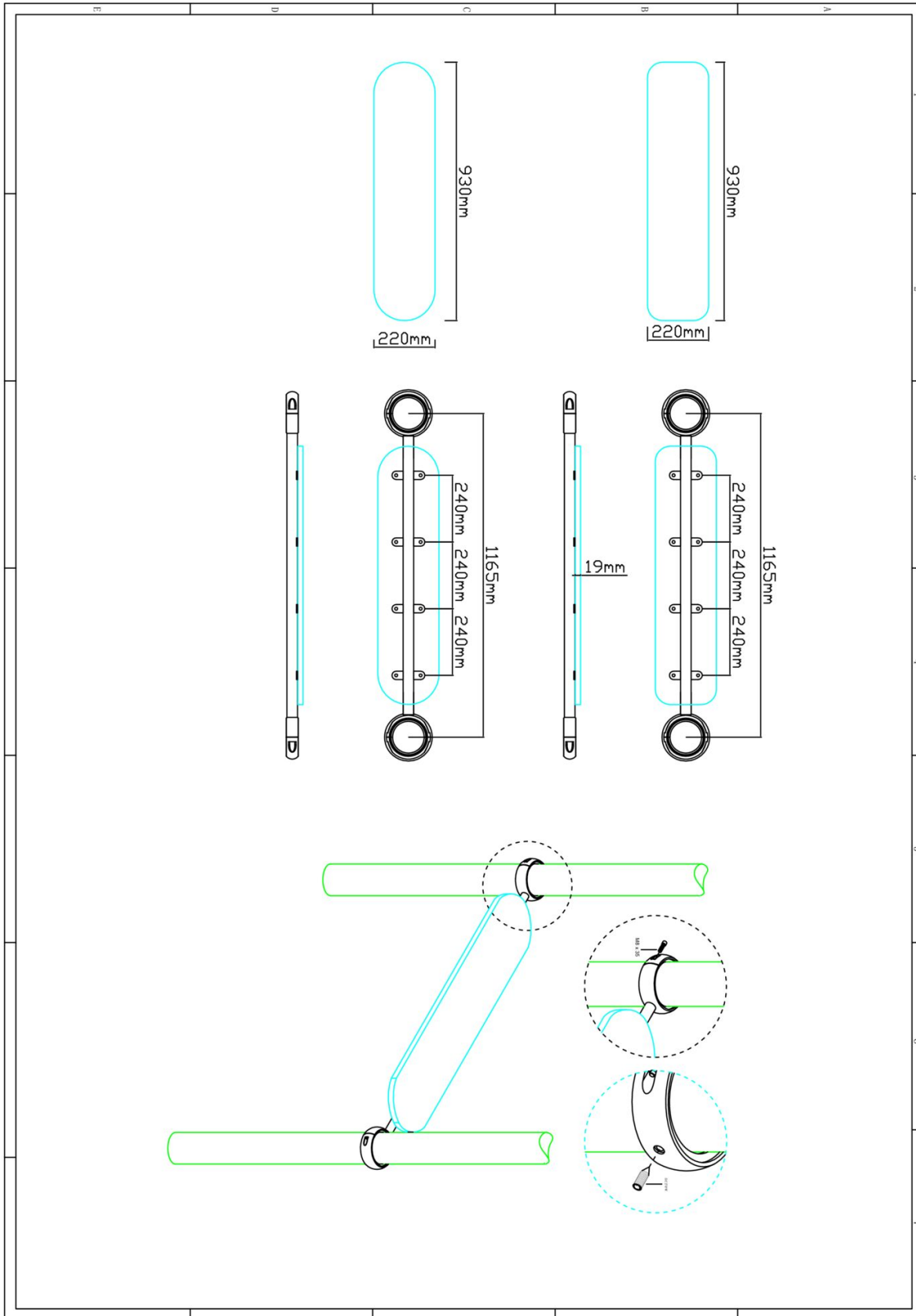

Bankje 2.0

STAP 1 van 1

Omschrijving: Bevestiging tussen de standers en de bank

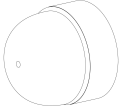
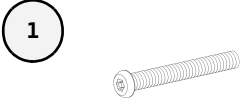
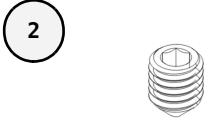
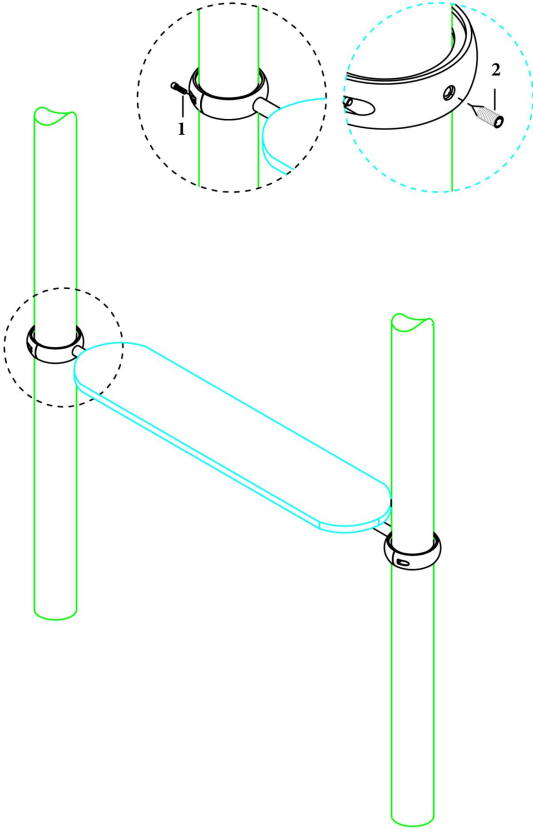
1 st. Bankje 2.0	8 st. Afdekdop M8	4 st. Torx M8X35	2 st. Inbus stelschroef M10x20
			
			
<p>Bevestigings materiaal is per zakje verpakt en bovenstaande afbeelding zit in het zakje</p>			

Tafel PE toestel

Hoofdafmetingen: 40x122cm

