

**TnT speeltoestellen**

# Montagehandleiding

## 3do-3799



---

Toestel	<b>3do-3799</b>
Datum montagehandleiding	<b>21-05-2026</b>

---

Beste klant van TnT Speeltoestellen,

Wij danken u voor het aanschaffen en installeren van een speeltoestel van TnT Speeltoestellen.  
Wij waarderen het vertrouwen dat u in ons bedrijf heeft geplaatst en streven ernaar om uw vertrouwen meer dan waar te maken!

Dit is uw TnT speeltoestellen montagehandleiding.

Wij hebben deze handleiding specifiek voor het product ontworpen, waarop eveneens de toe te passen onderdelen zijn genoemd.

Ook vindt u het grondplan met de benodigde valruimte volgens norm NEN-EN1176-1 : 2017.

Bewaart u dit document bij uw logboek. Nogmaals willen wij u bedanken voor de aankoop van dit speeltoestel. Wij zien uit naar uw volgende speelproject.

Met vriendelijke groet, TnT Speeltoestellen

## Inhoudsopgave

Aanzichten 3D	2
Onderdelenlijst	4
Veiligheidsruimtes	5
Zijaanzichten	6
Plattegrond palenplan	8
Paalmaten	9
Paaldata	10
Onderdeel handleidingen	11
Staander 320cm	12
Vloer vierkant (vloer_vierkant)	14
Ringladder kort (brug_klimrek_3_kort)	16
Metalen hekje (metalen_hekje)	26
Opgang doppen (opgang_doppen_120cm)	28
Half ronde opgang (klimrek_120cm_boog)	32
Glijstang (glijstang_120cm)	36
Opgang slang (b-klimmer_120cm)	40
Glijbaan RVS (glijbaan_120cm_metaal)	44
Bankje (bankje)	49

## Aanzichten 3D



Aanzicht 1



Aanzicht 2

## Aanzichten 3D





Aanzicht 3

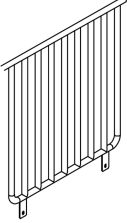
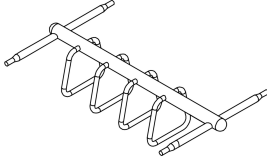
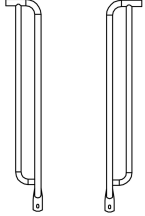
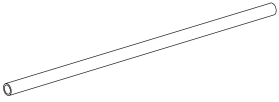
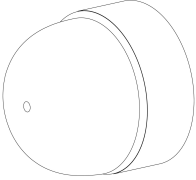
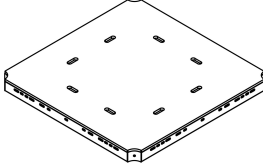
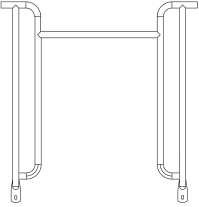
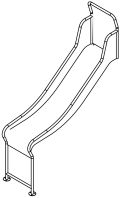
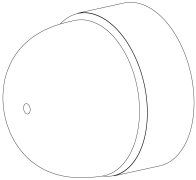
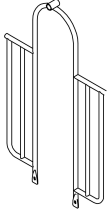

Aanzicht 4

## Onderdelenlijst

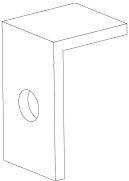
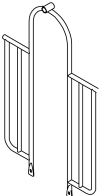
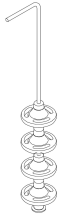
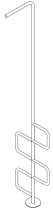
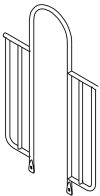
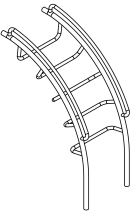
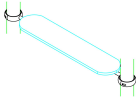
<p><b>8x</b> Staander 320cm 320x11,5cm</p> 	<p><b>1x</b> Balustrade metaal 105x101cm</p> 	<p><b>1x</b> Ring ladder 116,5cm 116,5x101cm</p> 	<p><b>2x</b> Handgrepen per 2 stuks 107x18cm</p> 
<p><b>2x</b> Stang onder ladder Ø3,2x101cm</p> 	<p><b>14x</b> Afdekdop M10 M10</p> 	<p><b>2x</b> Vloer vierkant HPL 117x117x8,5cm</p> 	<p><b>1x</b> Hek voor RVS glijbaan 104x101cm</p> 
<p><b>1x</b> RVS Glijbaan 120cm 216x257x54cm</p> 	<p><b>19x</b> Afdekdop M8 M8</p> 	<p><b>1x</b> Hekje tbv glijstang 152x101cm</p> 	<p><b>1x</b> 120cm Glijstang 332x42</p> 
<p><b>2x</b> Hoekje</p> 	<p><b>2x</b> Hekje tbv: B, Pod en Curly Climber 152x101cm</p> 	<p><b>1x</b> 120cm Pod climber 332x71cm</p> 	<p><b>1x</b> 120cm B climber 332x44cm</p> 
<p><b>1x</b> Hekje zonder bevestiging (boven) 152x101cm</p> 	<p><b>1x</b> 120cm Arch climber 190x121x73cm</p> 	<p><b>2x</b> Bankje 2.0 116x22x4cm</p> 	

# Veiligheidsruimtes

Geachte klant,

Zorg er altijd voor dat alle veiligheidsruimtes zoals aangegeven in ieder geval gehaald worden, dit zijn de minimale vereiste ruimtes voor een veilig gebruik van het speeltoestel.

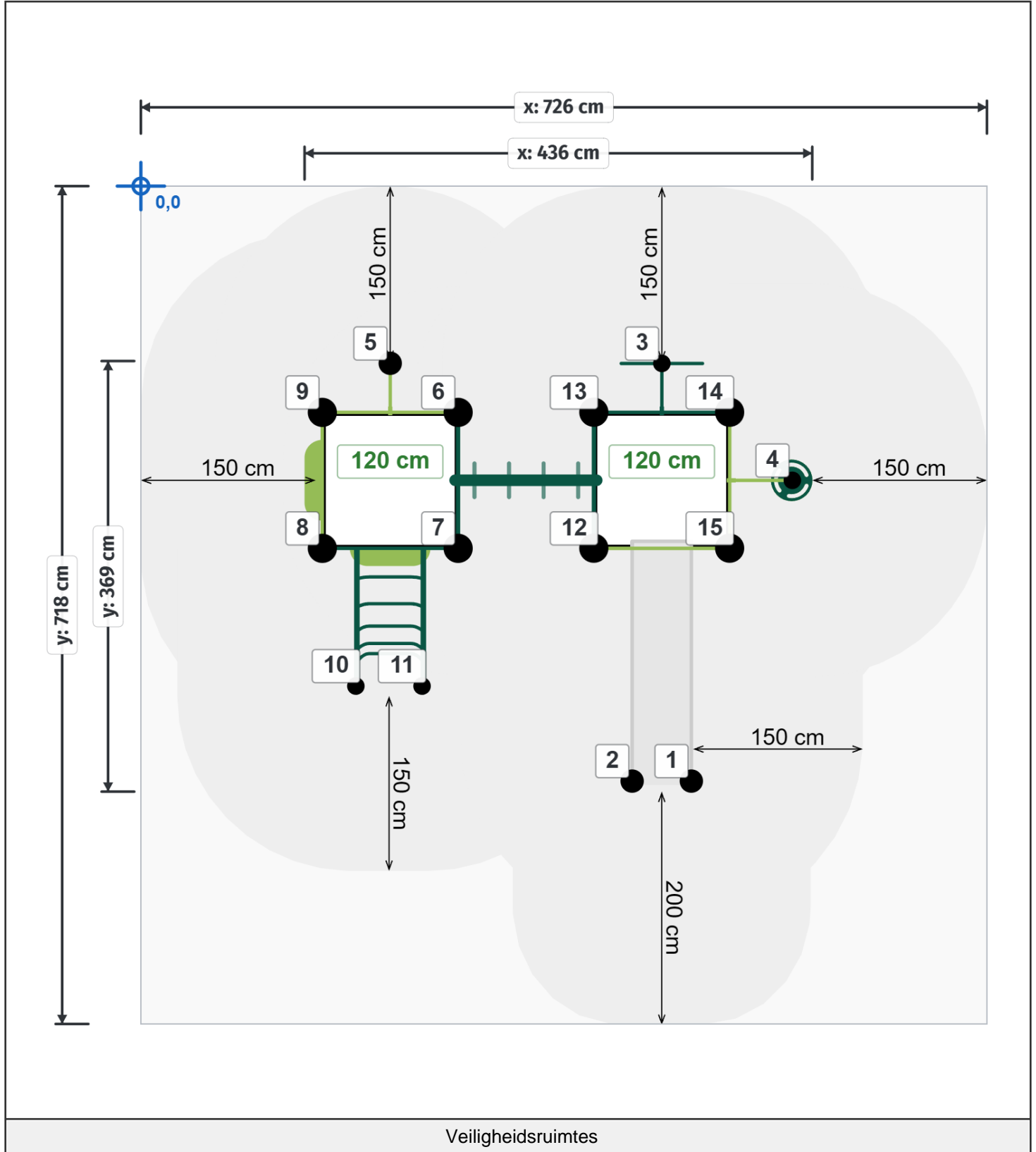

## Zijaanzichten

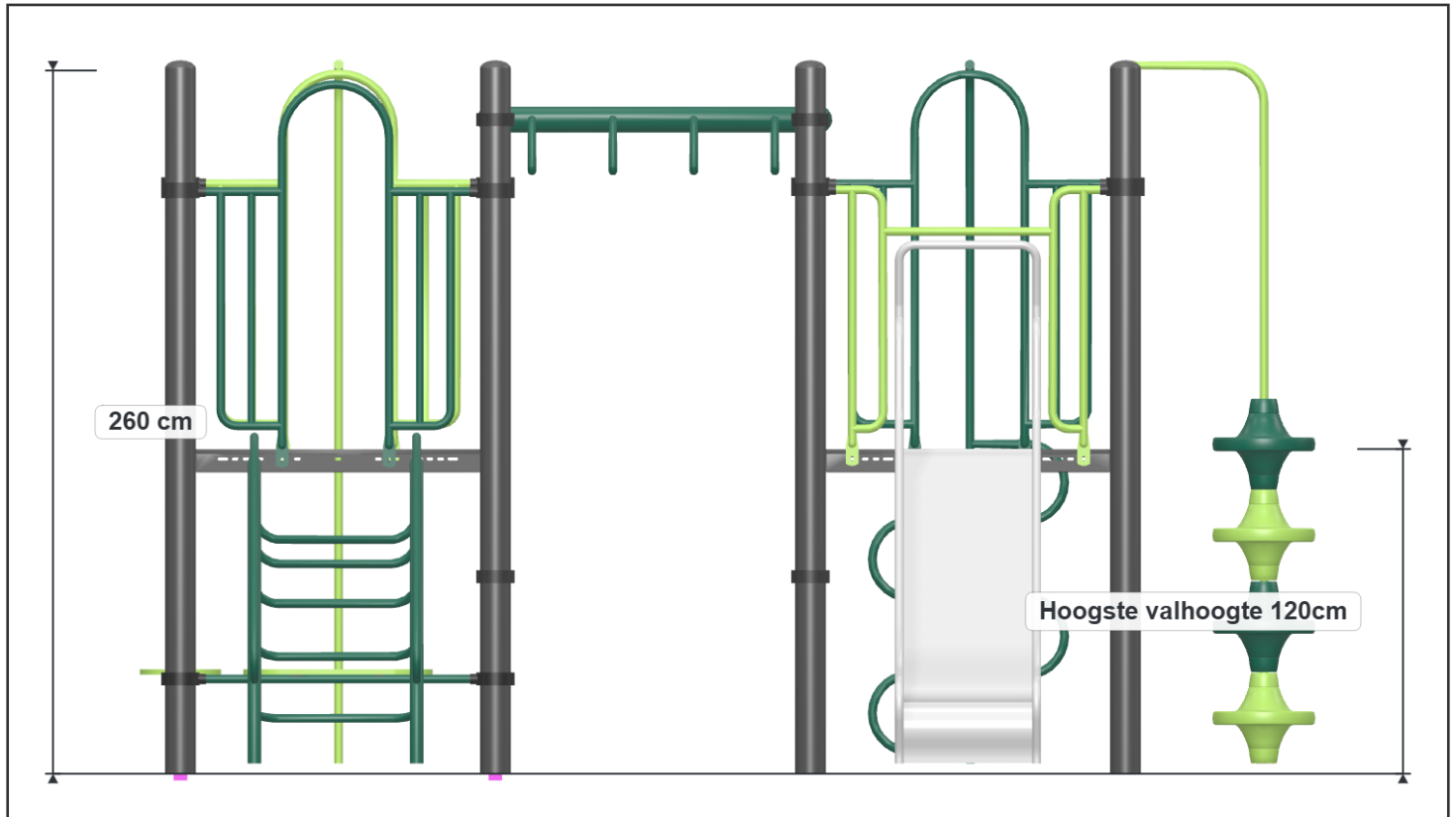

Aanzicht 1

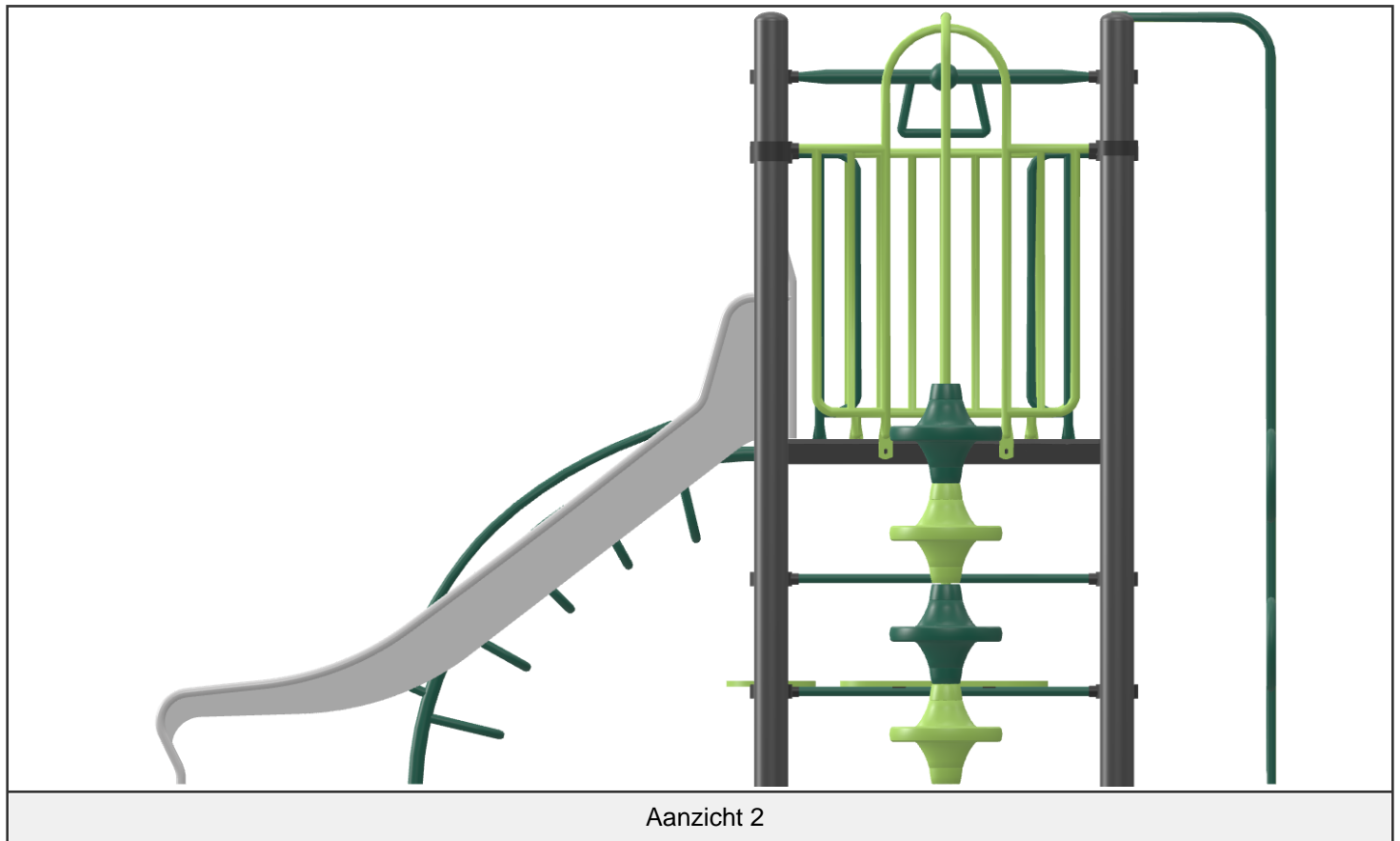

Aanzicht 2

## Zijaanzichten



Aanzicht 3



Aanzicht 4

## Plattegrond palenplan

U kunt van deze tekening niet afmeten!

Voor de betonfundatie heeft u 37,5 kg snelbeton per staander nodig.

Voor de overige onderdelen (Glijstangen, Climbers, Glijbaan voeten) 25 kg snelbeton.

Houdt u er rekening mee dat de betonfundatie minimaal 400mm onder het maaiveld blijft, zoals op de tekening afgebeeld.

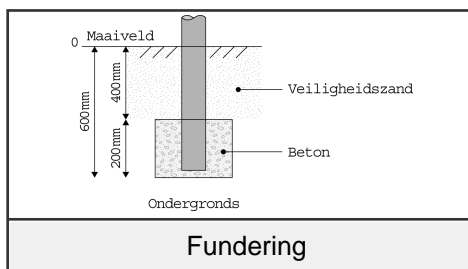
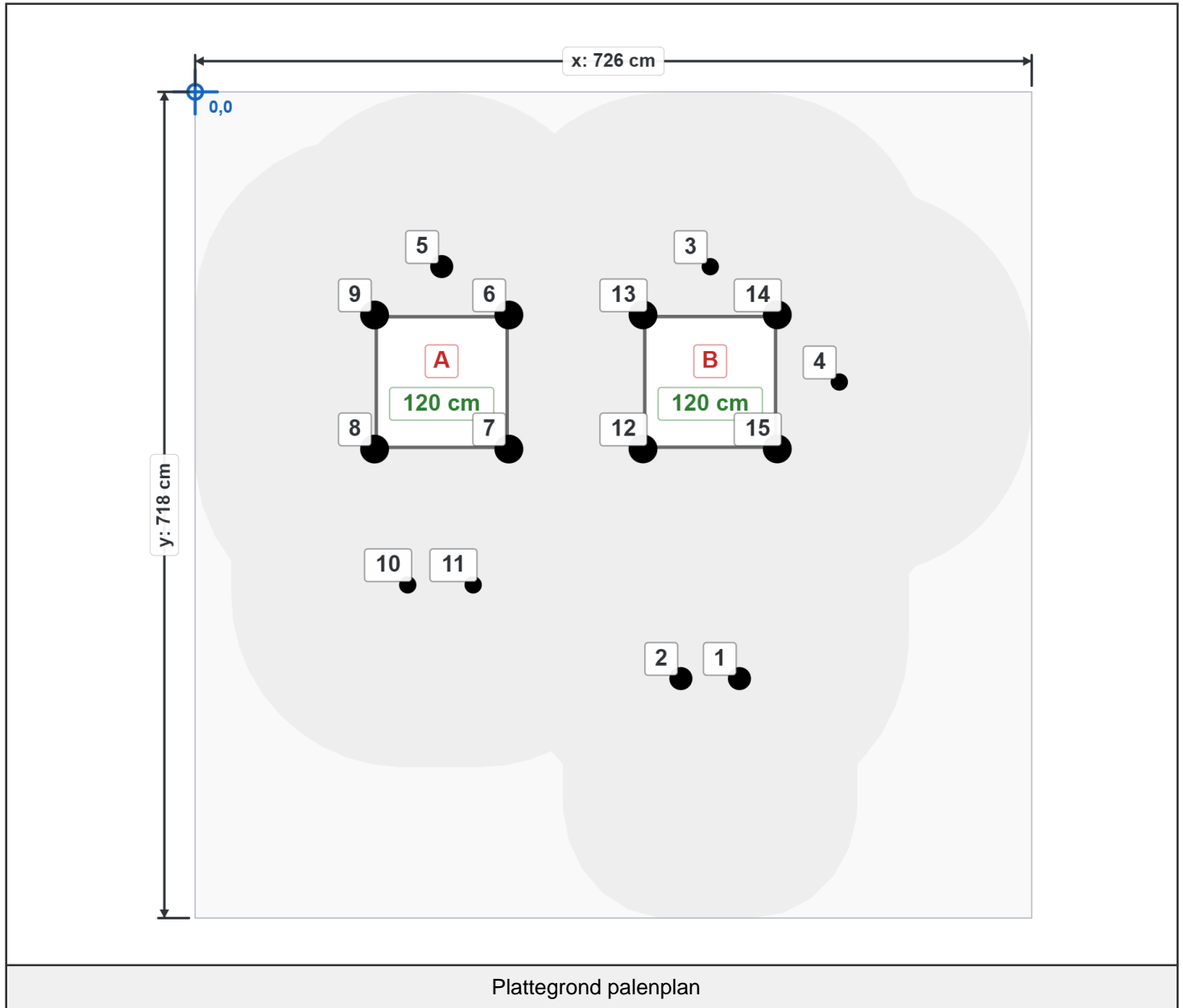

# Paalmaten

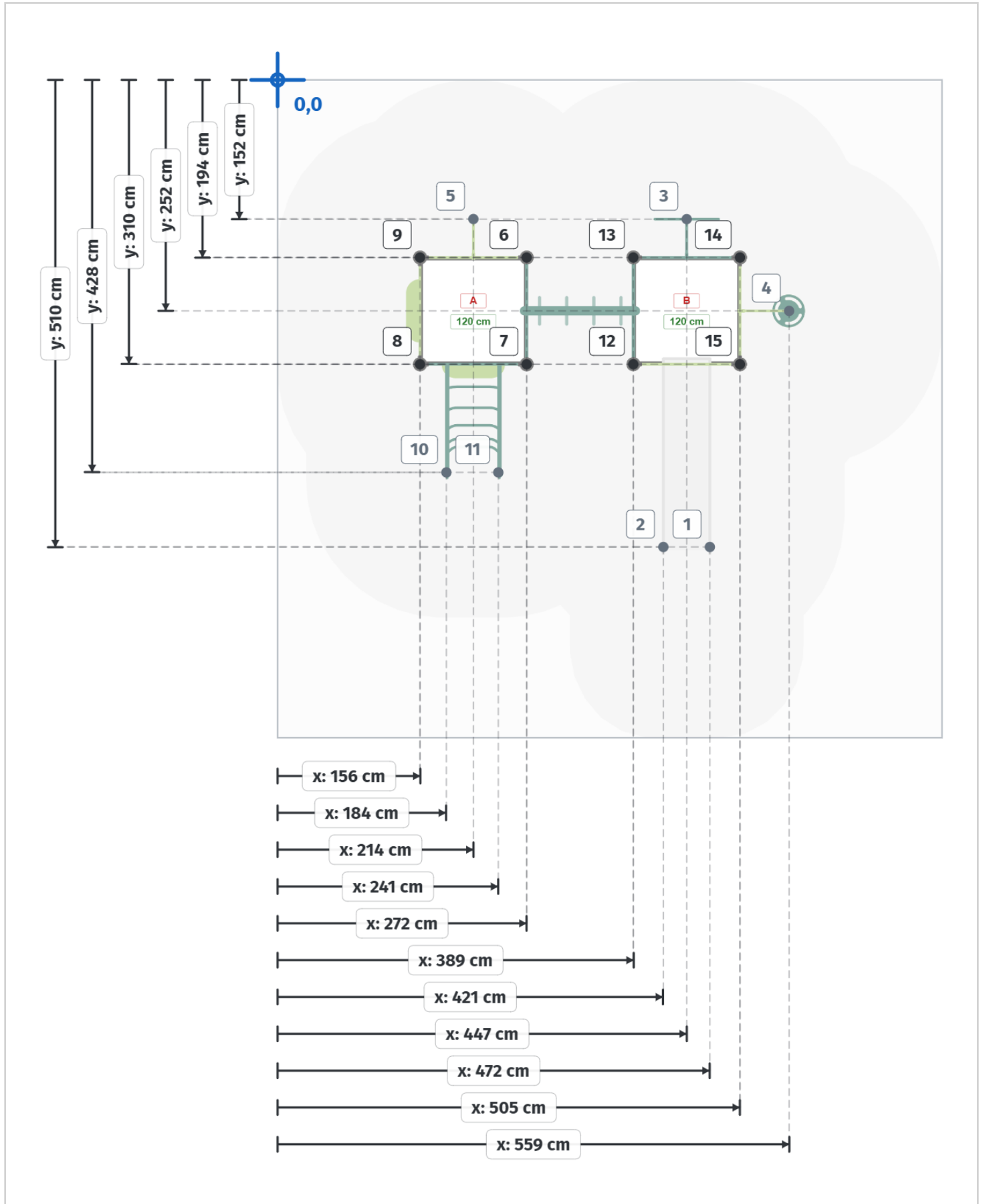

## Paaldata

Staanders			
Label	X	Y	Hoogte
1	473 cm	510 cm	0 cm
2	422 cm	510 cm	0 cm
3	447 cm	152 cm	0 cm
4	559 cm	253 cm	0 cm
5	214 cm	152 cm	0 cm
6	273 cm	194 cm	320 cm
7	273 cm	311 cm	320 cm
8	156 cm	311 cm	320 cm
9	156 cm	194 cm	320 cm
10	185 cm	429 cm	0 cm
11	242 cm	429 cm	0 cm
12	389 cm	311 cm	320 cm
13	389 cm	194 cm	320 cm
14	506 cm	194 cm	320 cm
15	506 cm	311 cm	320 cm

Vloeren	
Label	Hoogte
A	120 cm
B	120 cm

---

## Onderdeel handleidingen

Op de volgende pagina's van dit document vindt u alle individuele onderdelen met bijbehorende technische tekeningen en eventuele montage instructies.

# Staander 320cm

Hoofdafmetingen: 320x11,5cm

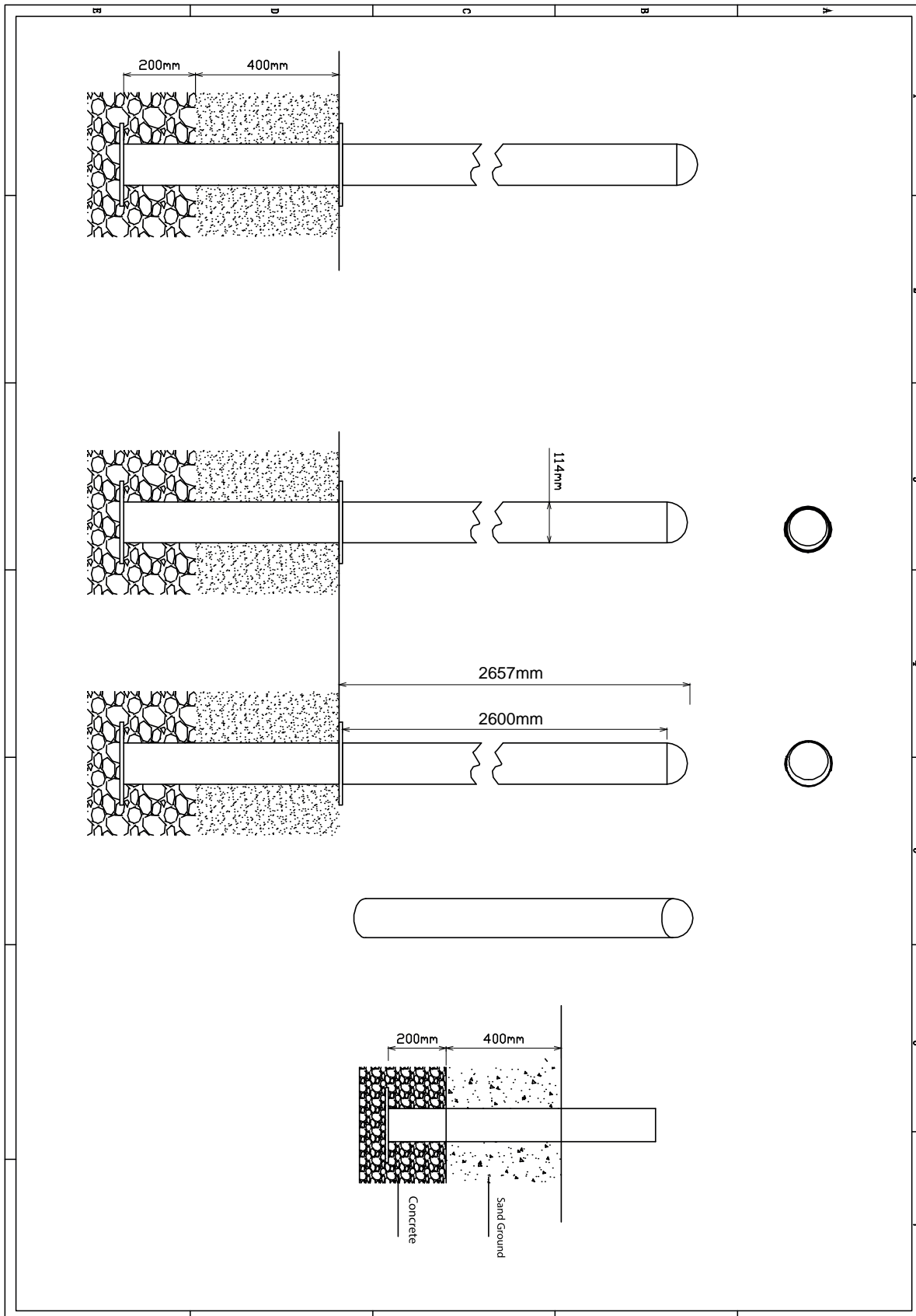

# Staander

STAP 1 van 1

Omschrijving: Paalkap losdraaien en opnieuw bevestigen met loctite op het draadeind

1 st. Loctite

1 

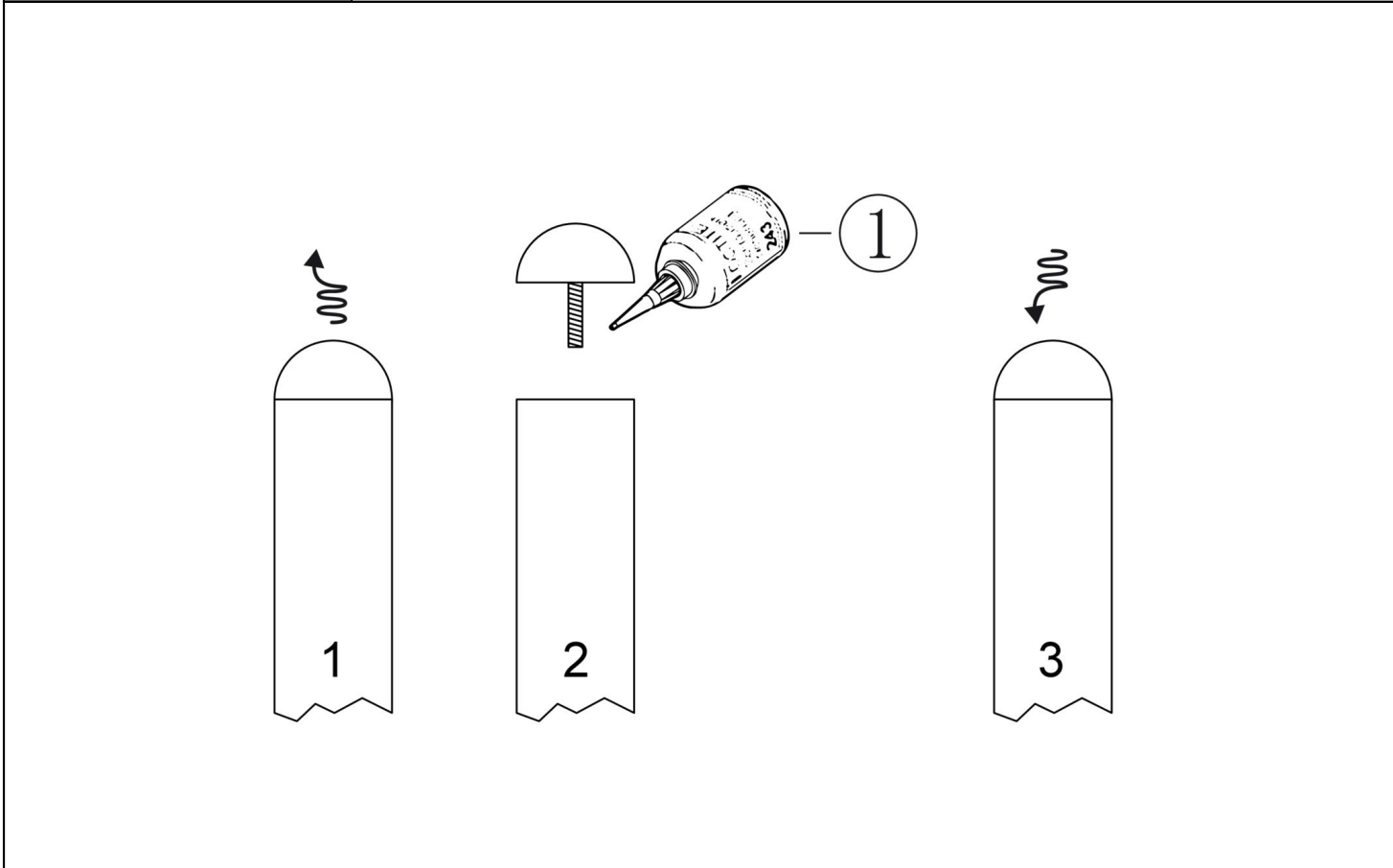

Bevestigings materiaal is per zakje verpakt en bovenstaande afbeelding zit in het zakje

# Vloer vierkant HPL

Hoofdafmetingen: 117x117x8,5cm

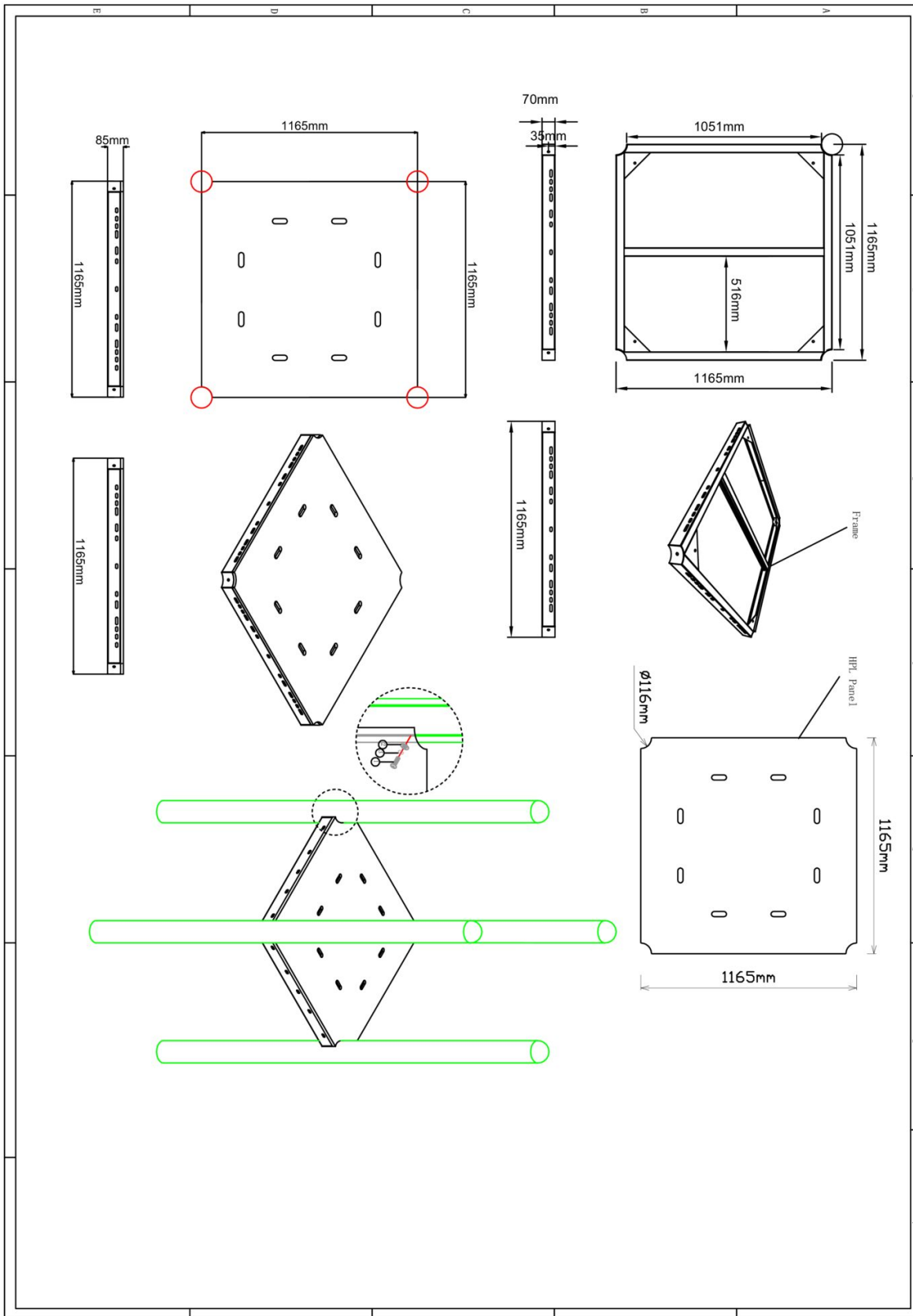

## Vloer vierkant HPL

STAP 1 van 1

**Omschrijving:** Bevestiging van de vloer aan de staander. In de staander zitten al voor gemonteerde M10 bussen op de juiste hoogte waar de bout ingedraaid dienen te worden.

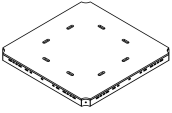
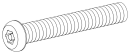
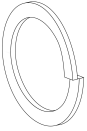
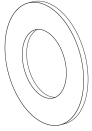
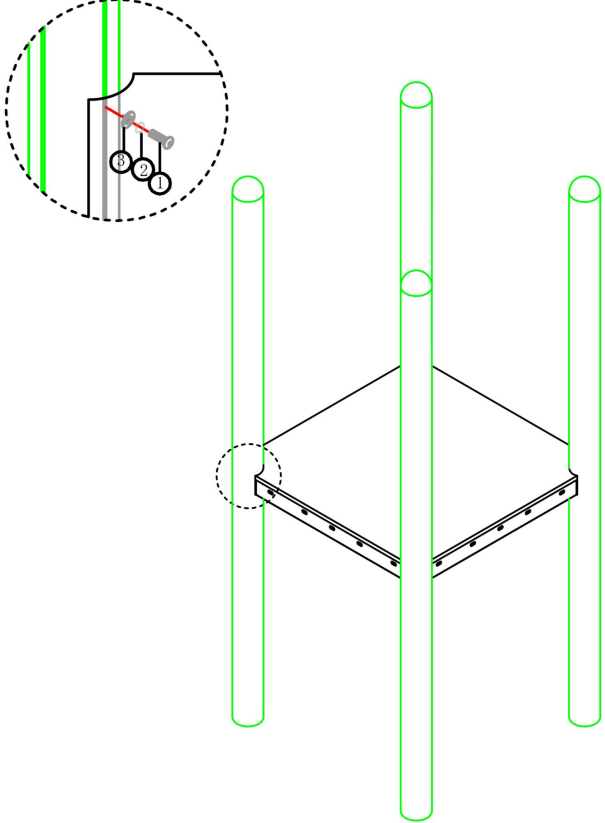
1 st. Vloer vierkant HPL	4 st. Torx M10X30	4 st. Veerring M10	4 st. Ring M10 (middel)
	<p>1</p> 	<p>2</p> 	<p>3</p> 
			
<p>Bevestigings materiaal is per zakje verpakt en bovenstaande afbeelding zit in het zakje</p>			



# Ring ladder 116,5cm

STAP 1 van 3

Omschrijving: Zelftap bouten aanbrengen aan de binnenkant van de palen

4 st. Zeskant M3X16  
Zelftap

1

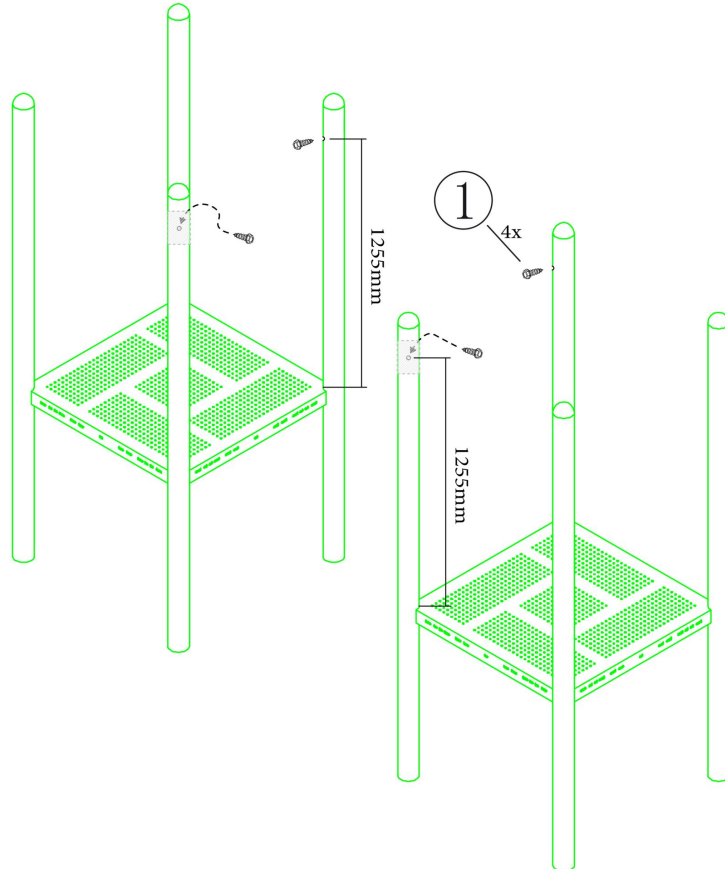

Bevestigings materiaal is per zakje verpakt en bovenstaande afbeelding zit in het zakje

## Ring ladder 116,5cm

STAP 2 van 3

**Omschrijving:** Koppelingsring over de schroef schuiven en vastzetten zodat de schroef niet meer zichtbaar is en de ring door de schroef niet kan zakken op de paal

4 st. Small clamp + ring

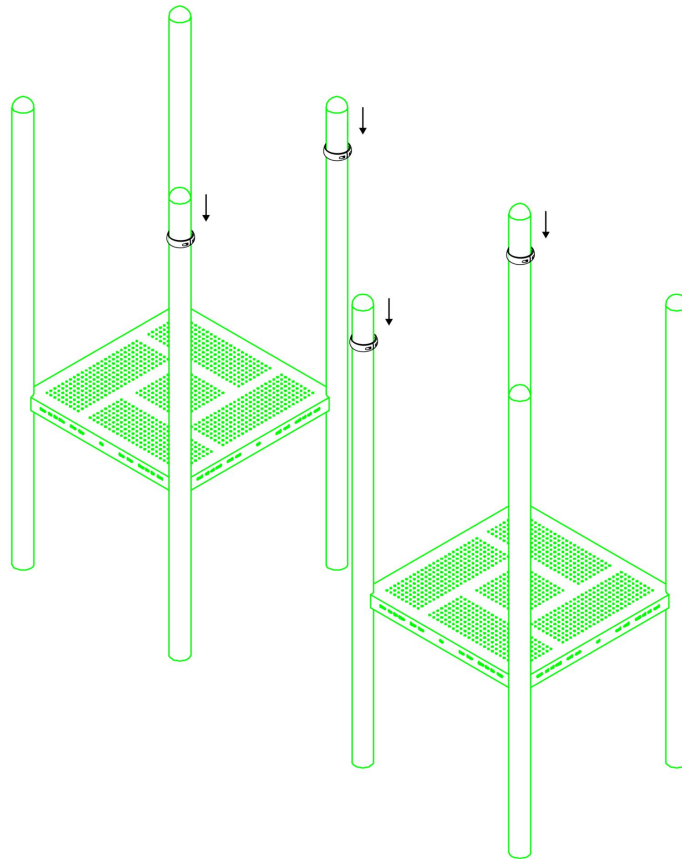



Bevestigings materiaal is per zakje verpakt en bovenstaande afbeelding zit in het zakje

## Ring ladder 116,5cm

STAP 3 van 3

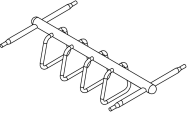
**Omschrijving:** Bevestiging tussen de ring ladder en de staander. De bevestigingsring van de ring ladder moet vanaf de vloer gemeten op 125cm hoogte hangen

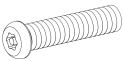
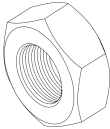
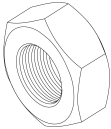
<p>1 st. Ring ladder 116,5cm</p> 	<p>4 st. Kruiskop M6X65</p> <p>1</p> 	
<p>8 st. Torx M8X20</p> <p>2</p> 	<p>8 st. Lock Moer M8</p> <p>3</p> 	<p>4 st. Lock Moer M6</p> <p>4</p> 

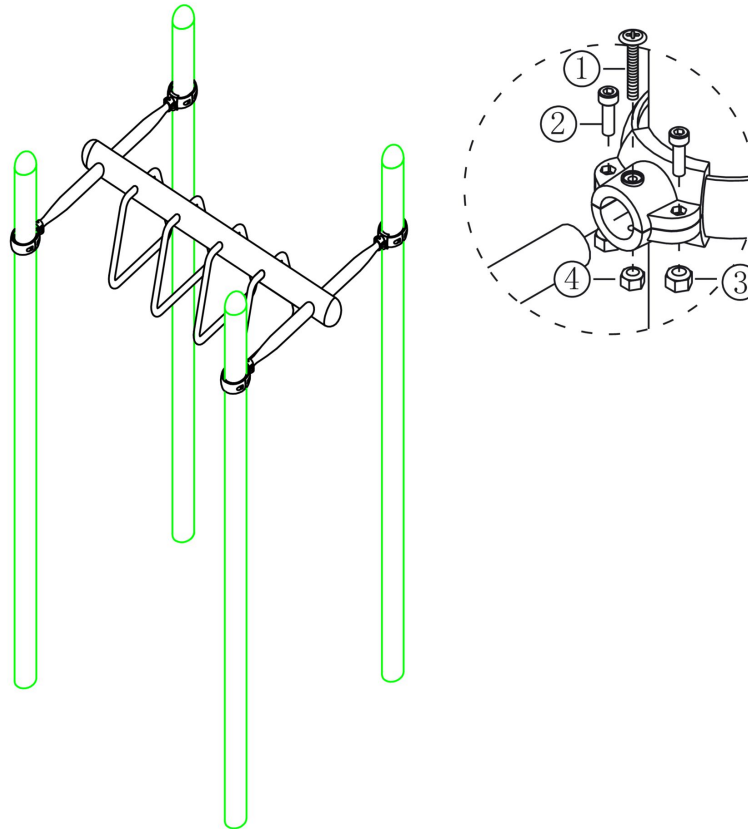

Bevestigings materiaal is per zakje verpakt en bovenstaande afbeelding zit in het zakje

### Handgrepen per 2 stuks



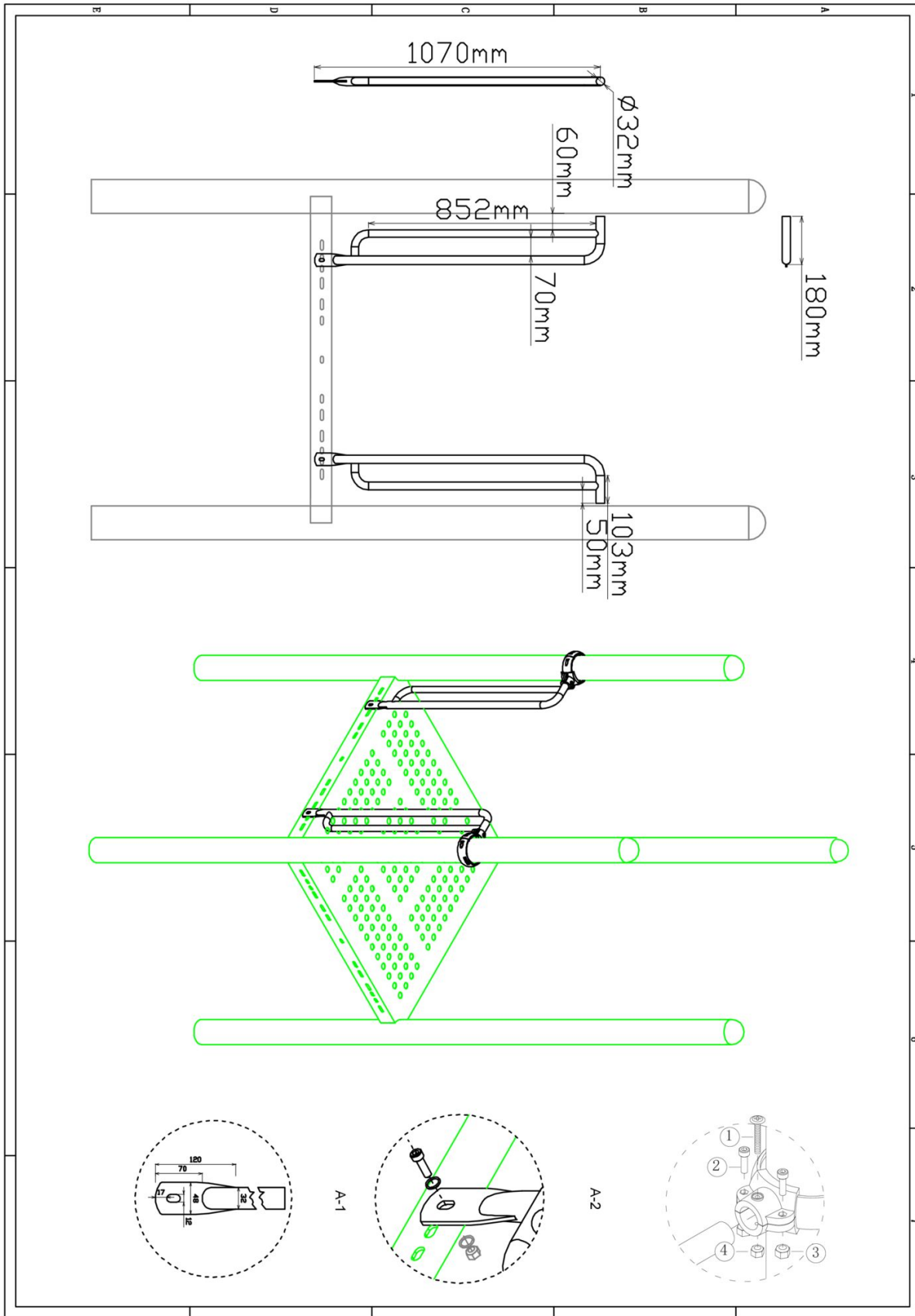

Hoofdafmetingen: 107x18cm

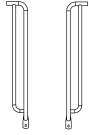

## Handgrepen per 2 stuks

STAP 1 van 1

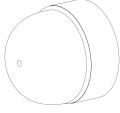
Omschrijving: Bevestiging tussen de vloer/staander en de handgrepen

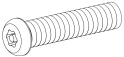
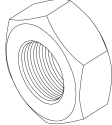
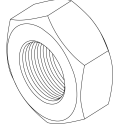
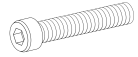
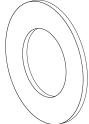
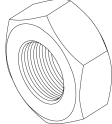
1 st. Handgrepen per 2 stuks	2 st. Small clamp + ring	2 st. Afdekdop M10	2 st. Kruiskop M6X65
			
4 st. Torx M8X20	4 st. Lock Moer M8	4 st. Lock Moer M6	2 st. Bout M10X25
			
4 st. Ring M10 (middel)	2 st. Lock Moer M10		
			

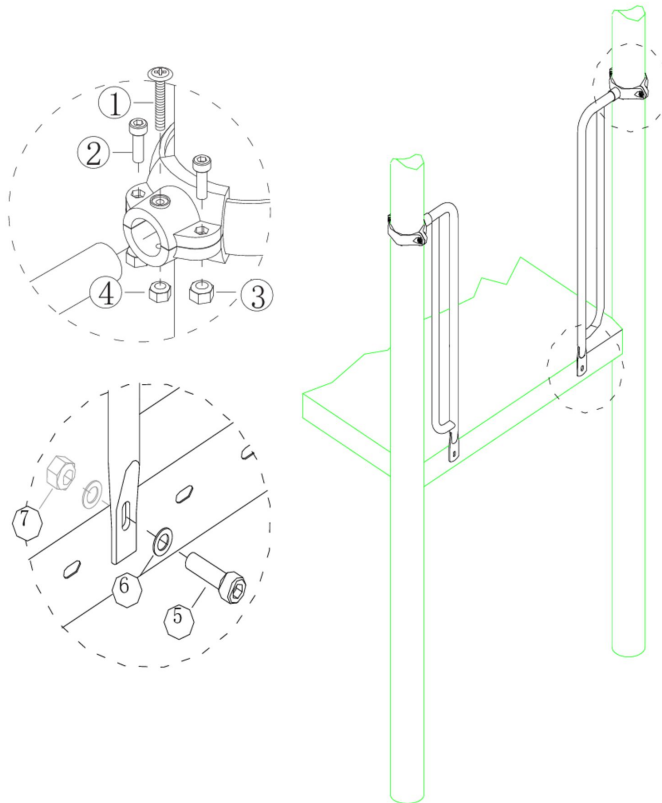

Bevestigings materiaal is per zakje verpakt en bovenstaande afbeelding zit in het zakje

## Stang onder ladder

Hoofdafmetingen:  $\emptyset 3,2 \times 101 \text{cm}$

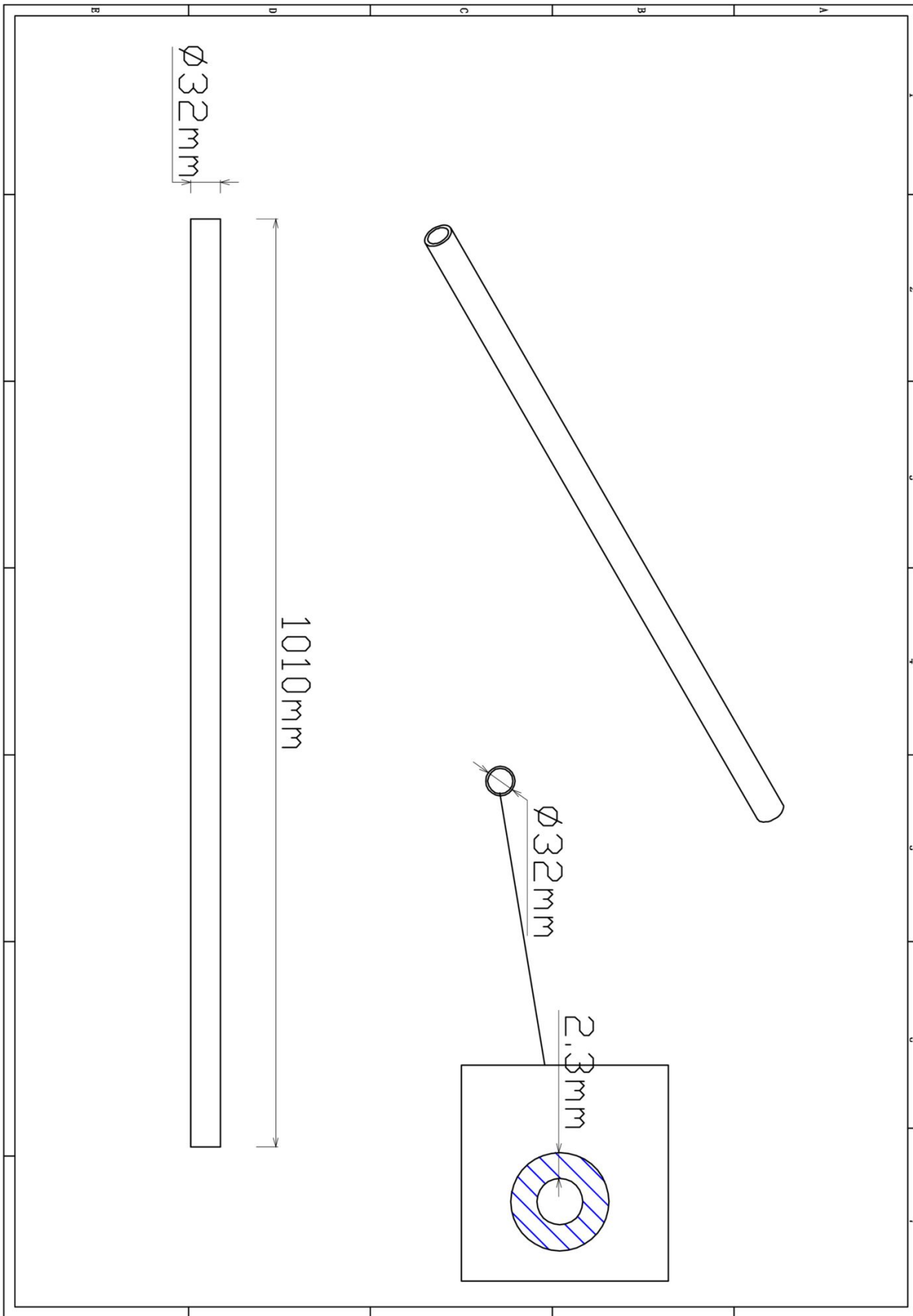

## Stang onder ladder

STAP 1 van 3

Omschrijving: Zelftap bouten aanbrengen aan de binnenkant van de palen

2 st. Zeskant M3X16  
Zelftap

1

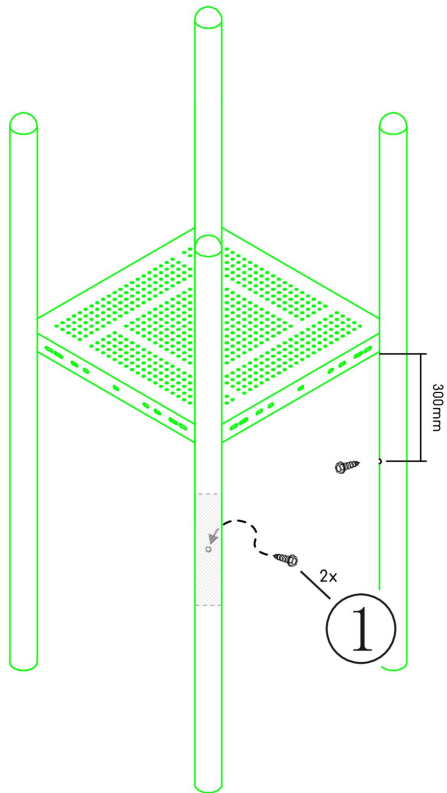
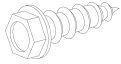

Bevestigings materiaal is per zakje verpakt en bovenstaande afbeelding zit in het zakje

## Stang onder ladder

STAP 2 van 3

**Omschrijving:** Koppelingsring over de schroef schuiven en vastzetten zodat de schroef niet meer zichtbaar is en de ring door de schroef niet kan zakken op de paal

2 st. Small clamp + ring

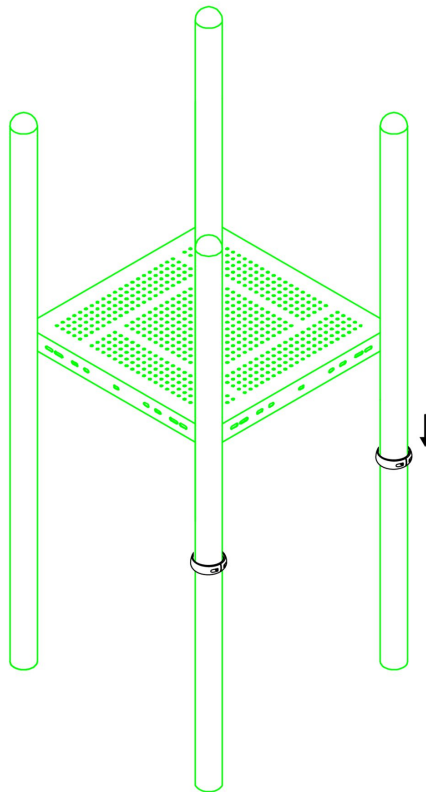

Bevestigings materiaal is per zakje verpakt en bovenstaande afbeelding zit in het zakje

# Stang onder ladder

STAP 3 van 3

Omschrijving: Stang vastzetten met behulp van de klemmen

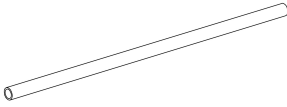
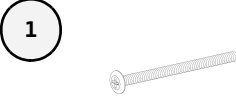
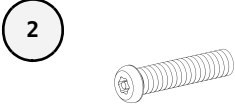
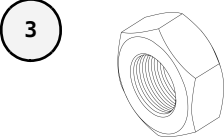
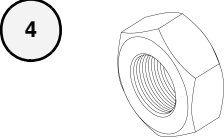
1 st. Stang onder ladder	2 st. Kruiskop M6X65	
		
4 st. Torx M8X20	4 st. Lock Moer M8	2 st. Lock Moer M6
		

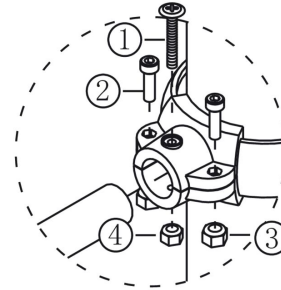
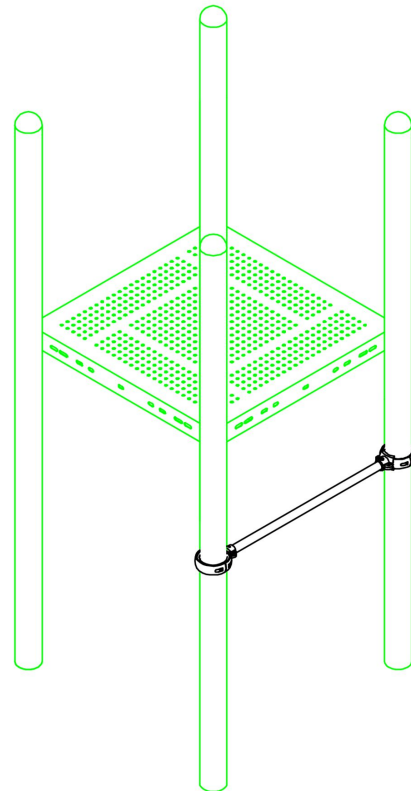







Bevestigings materiaal is per zakje verpakt en bovenstaande afbeelding zit in het zakje

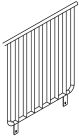

# Balustrade metaal

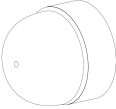
STAP 1 van 1

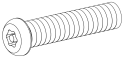
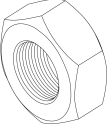
Omschrijving: Bevestiging tussen de vloer/staander

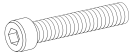
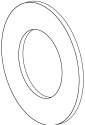
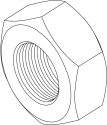
1 st. Balustrade metaal	2 st. Small clamp + ring	2 st. Afdekdop M10	2 st. Kruiskop M6X65
			① 
4 st. Torx M8X20	4 st. Lock Moer M8	2 st. Lock Moer M6	2 st. Bout M10X25
② 	③ 	④ 	⑤ 
4 st. Ring M10 (middel)	2 st. Lock Moer M10		
⑥ 	⑦ 		

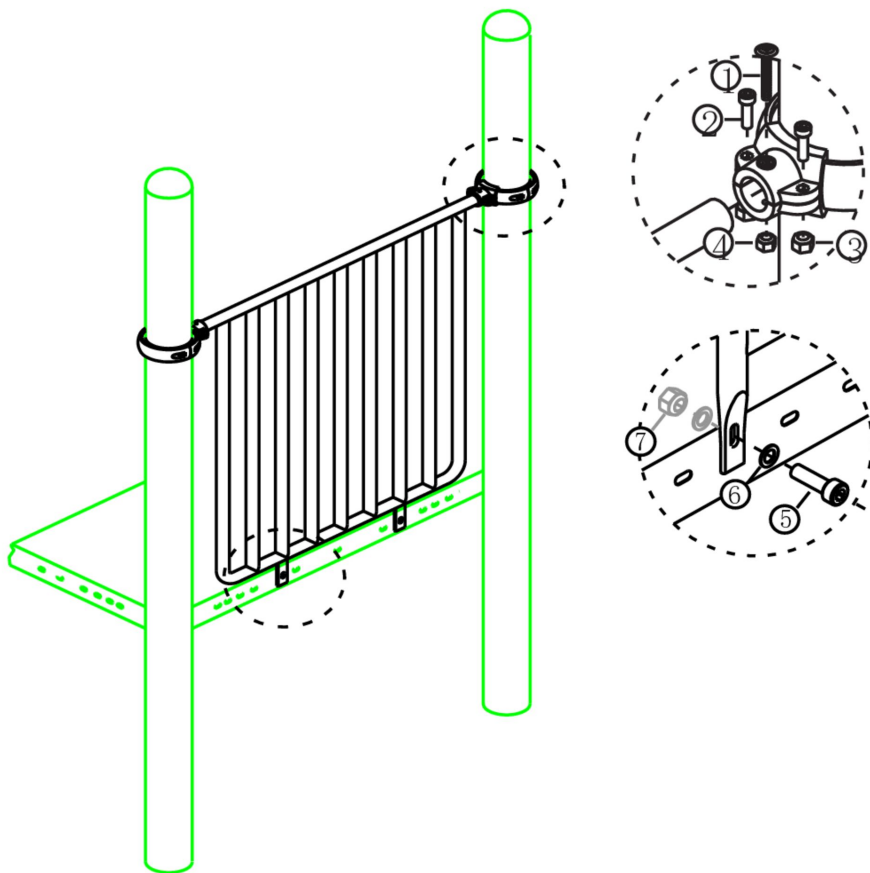





Bevestigings materiaal is per zakje verpakt en bovenstaande afbeelding zit in het zakje

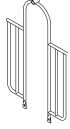

## Hekje tbv: B, Pod en Curly Climber

STAP 1 van 1

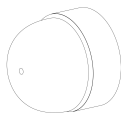
Omschrijving: Bevestiging van het hek tussen de vloer/staander

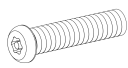
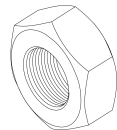
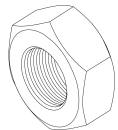
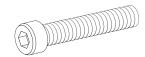
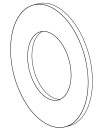
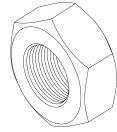
1 st. Hekje tbv: B, Pod en Curly Climber	2 st. Small clamp + ring	2 st. Afdekdop M10	2 st. Kruiskop M6X65
			① 
4 st. Torx M8X20	4 st. Lock Moer M8	2 st. Lock Moer M6	2 st. Bout M10X25
② 	③ 	④ 	⑤ 
4 st. Ring M10 (middel)	2 st. Lock Moer M10		
⑥ 	⑦ 		

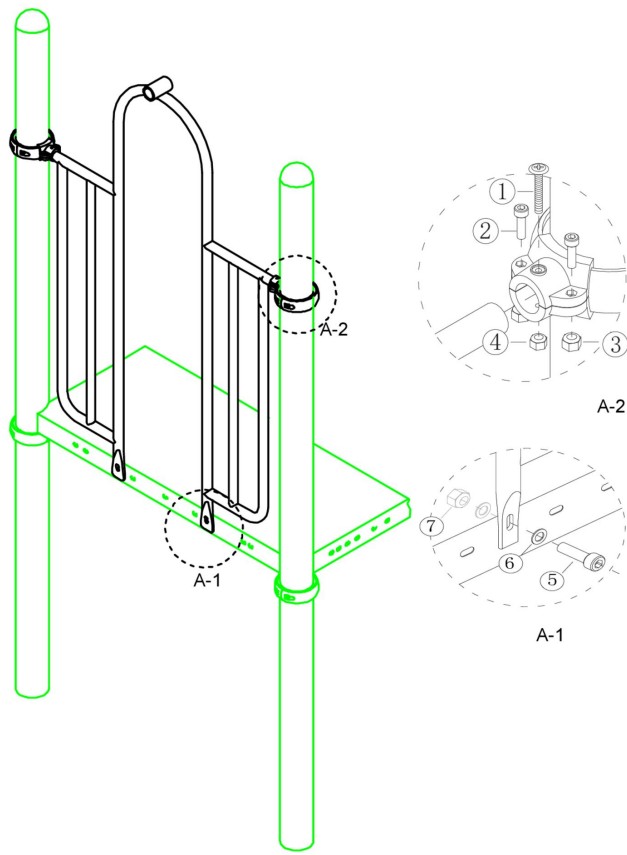

Bevestigings materiaal is per zakje verpakt en bovenstaande afbeelding zit in het zakje

### 120cm Pod climber

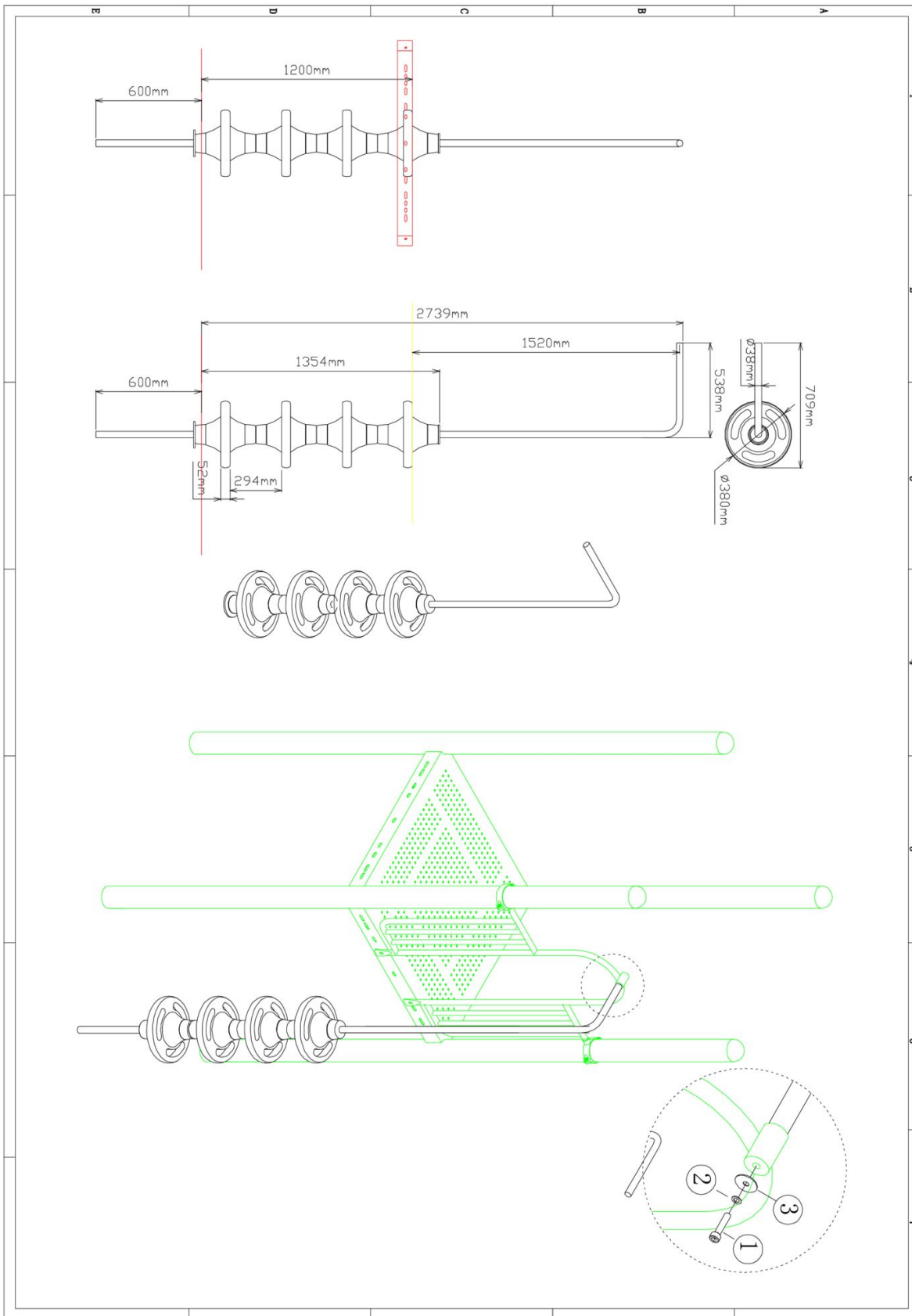

Hoofdafmetingen: 332x71cm



# 120cm Pod climber

STAP 1 van 1

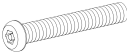
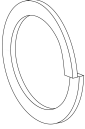
Omschrijving: Bevestiging tussen hek en pod climber

1 st. 120cm Pod climber	1 st. Torx M10X30	1 st. Veerring M10	1 st. Ring M10 (middel)
			

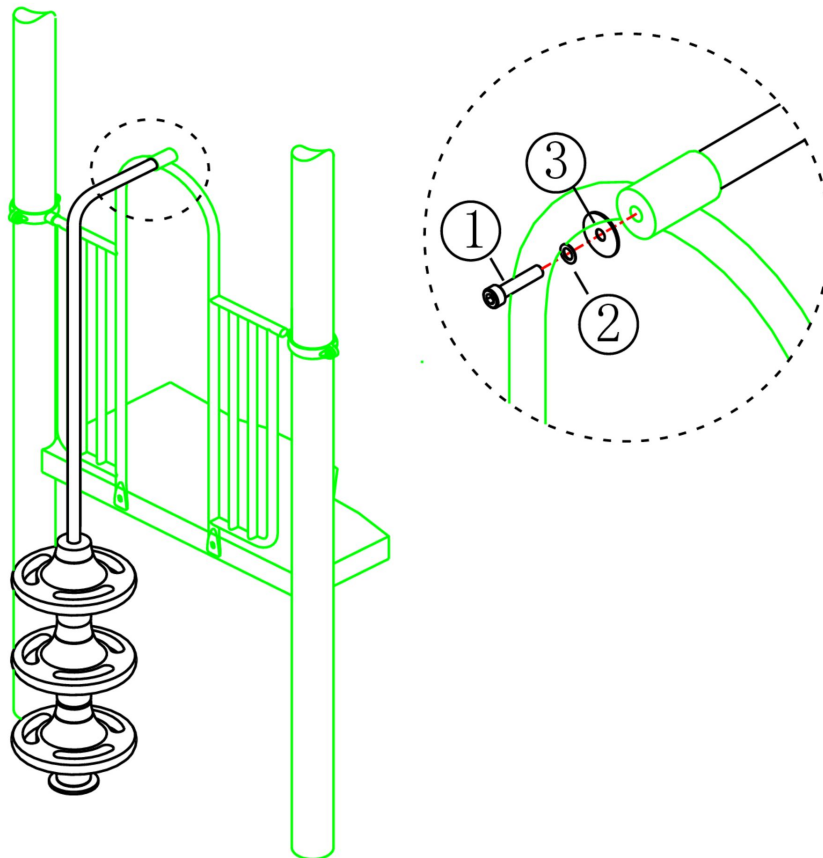

Bevestigings materiaal is per zakje verpakt en bovenstaande afbeelding zit in het zakje

# Hekje zonder bevestiging (boven)



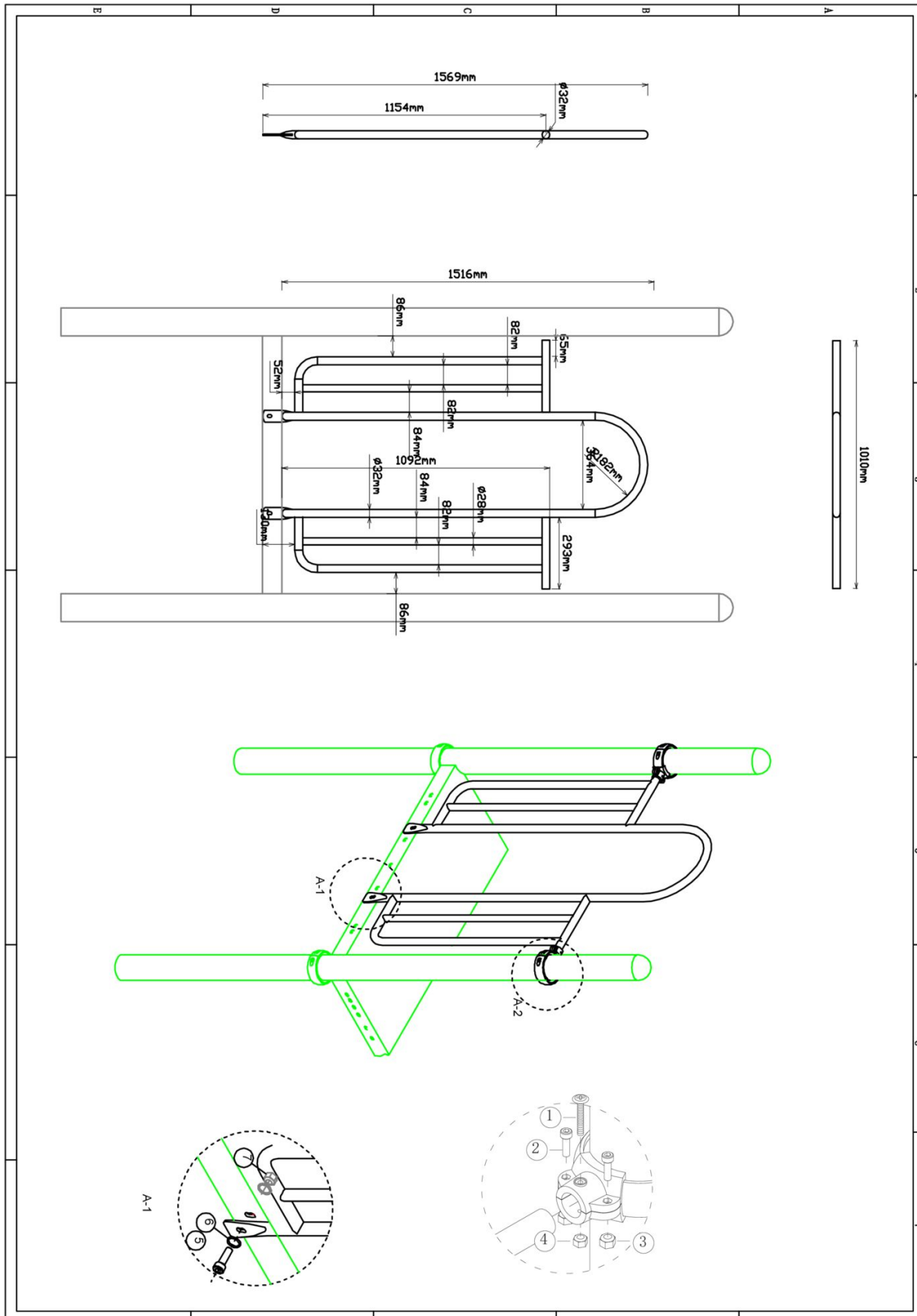

Hoofdafmetingen: 152x101cm

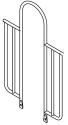

## Hekje zonder bevestiging (boven)

STAP 1 van 1

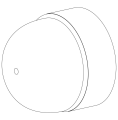
Omschrijving: Bevestiging van het hek tussen de vloer/staander

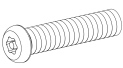
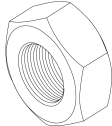
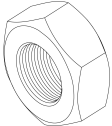
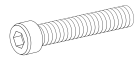
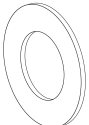
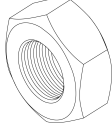
1 st. Hekje zonder bevestiging (boven)	2 st. Small clamp + ring	2 st. Afdekdop M10	2 st. Kruiskop M6X65
			
4 st. Torx M8X20	4 st. Lock Moer M8	2 st. Lock Moer M6	2 st. Bout M10X25
			
4 st. Ring M10 (middel)	2 st. Lock Moer M10		
			

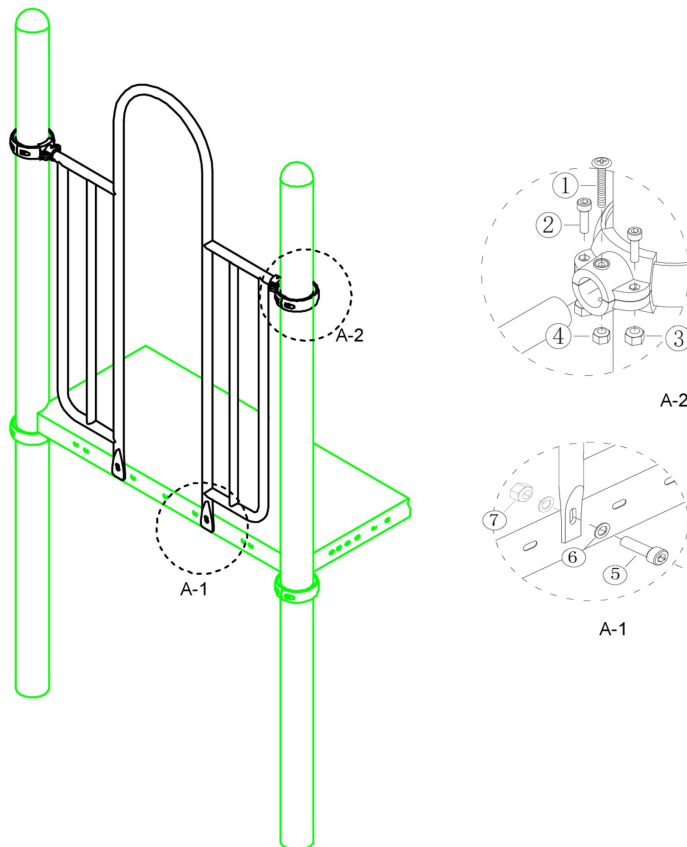

Bevestigings materiaal is per zakje verpakt en bovenstaande afbeelding zit in het zakje

## 120cm Arch climber

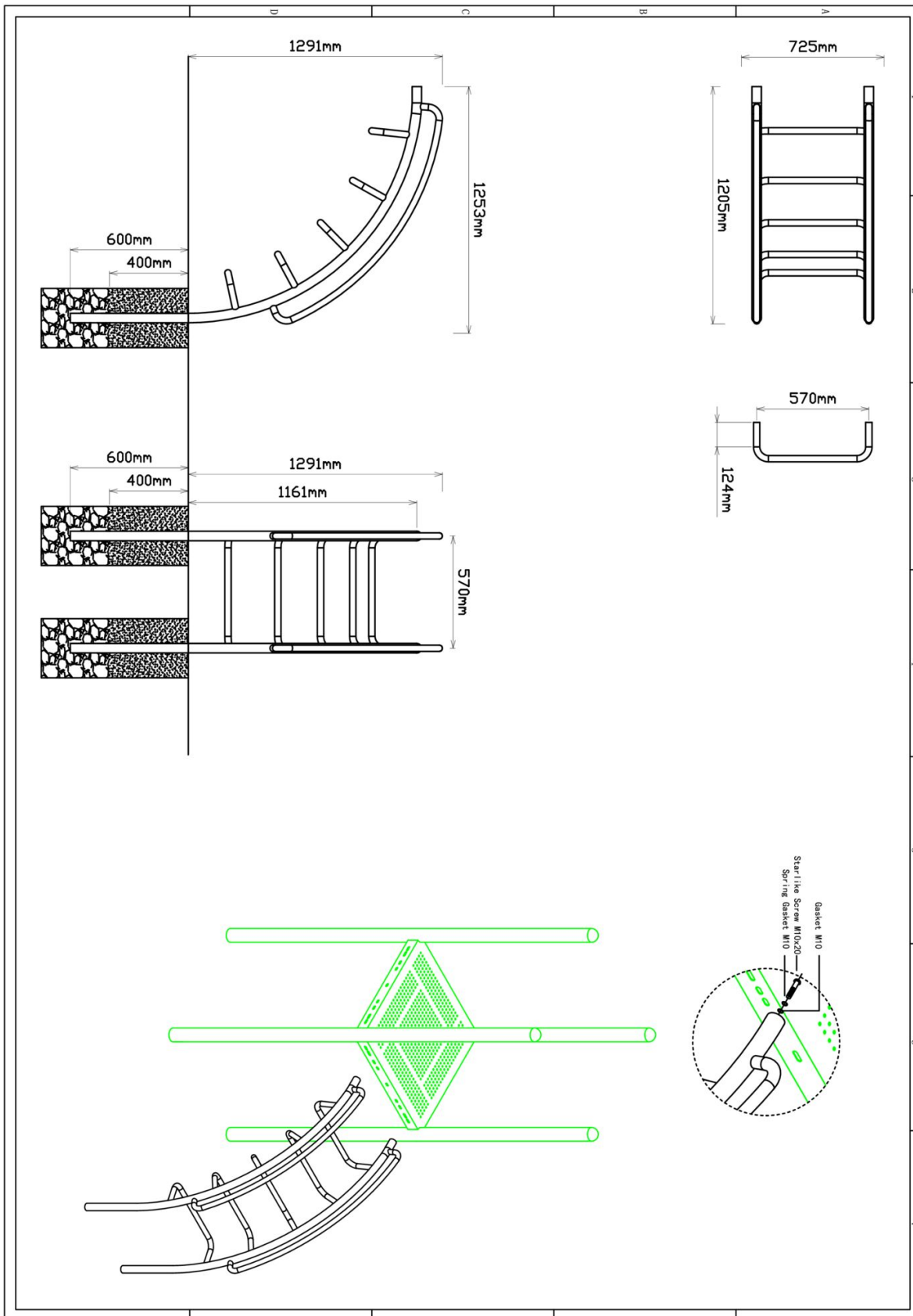

Hoofdafmetingen: 190x121x73cm



# 120cm Arch climber

STAP 1 van 1

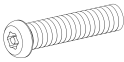
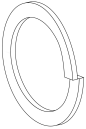
Omschrijving: Bevestiging tussen vloer en Arch climber

1 st. 120cm Arch climber	2 st. Torx M10X20	2 st. Veerring M10	2 st. Ring M10 (middel)
			

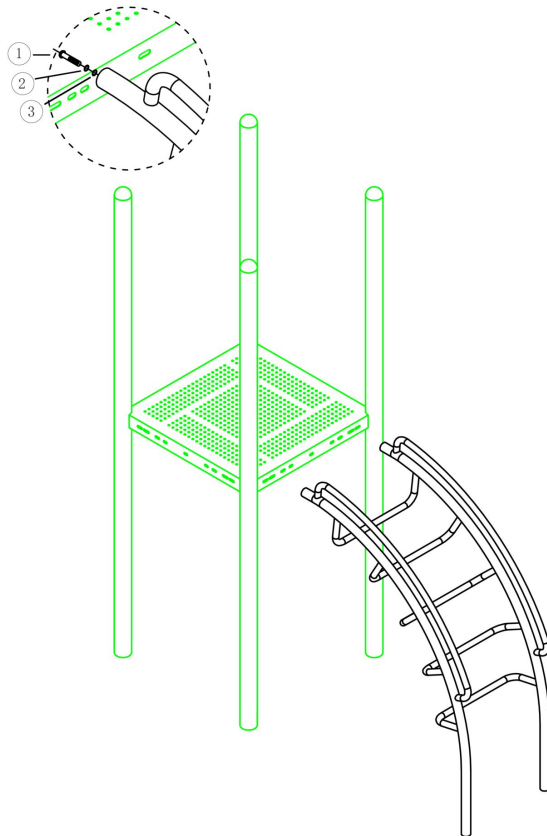









Bevestigings materiaal is per zakje verpakt en bovenstaande afbeelding zit in het zakje

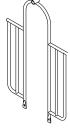

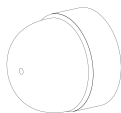
## Hekje tbv glijstang

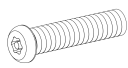
STAP 1 van 1

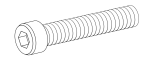
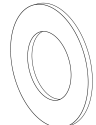
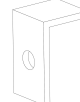
Omschrijving: Bevestiging van het hek tussen de vloer/staander

1 st. Hekje tbv glijstang	2 st. Small clamp + ring	2 st. Afdekdop M10	2 st. Kruiskop M6X65
			
4 st. Torx M8X20	4 st. Lock Moer M8	2 st. Lock Moer M6	2 st. Bout M10X25
			
4 st. Ring M10 (middel)	2 st. Hoekje	2 st. Lock Moer M10	
			

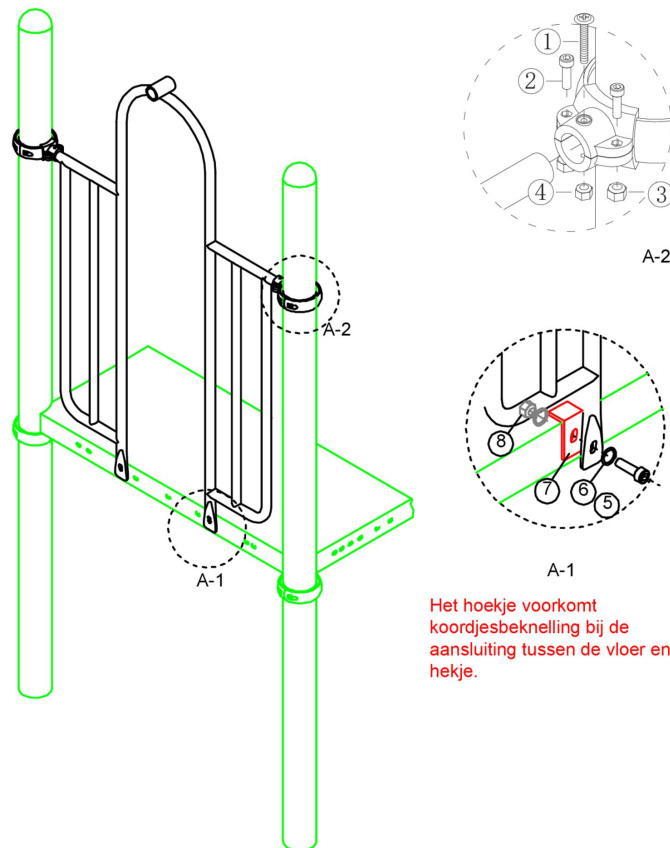

Het hoekje voorkomt koordjesbeknelling bij de aansluiting tussen de vloer en het hekje.

Bevestigings materiaal is per zakje verpakt en bovenstaande afbeelding zit in het zakje

## 120cm Glijstang

Hoofdafmetingen: 332x42

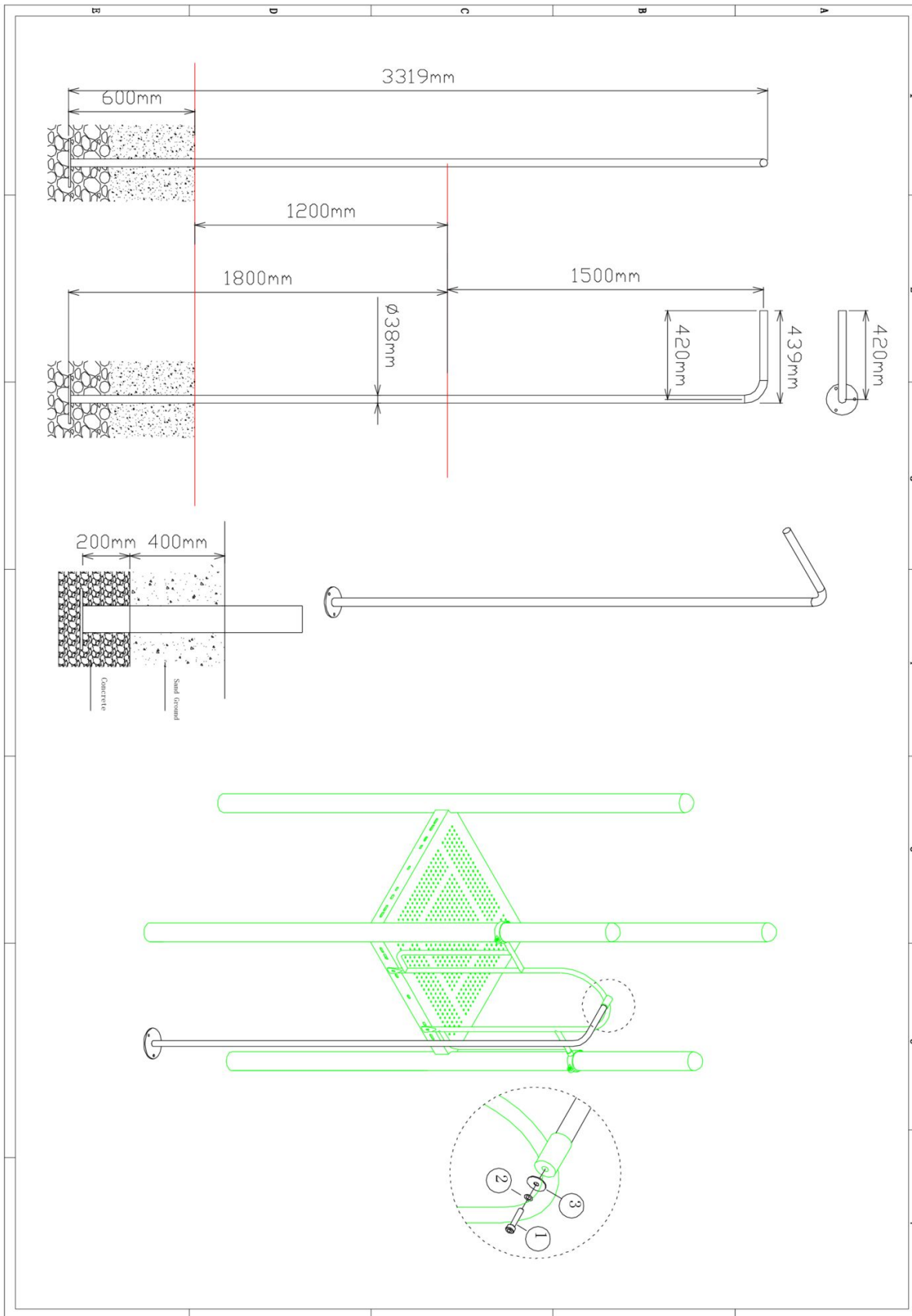

# 120cm Glijstang

STAP 1 van 1

Omschrijving: Bevestiging tussen de glijstang en het hek

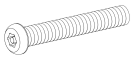
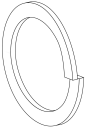
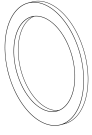
1 st. 120cm Glijstang	1 st. Torx M10X30	1 st. Veerring M10	1 st. Ring M10 (groot)
			

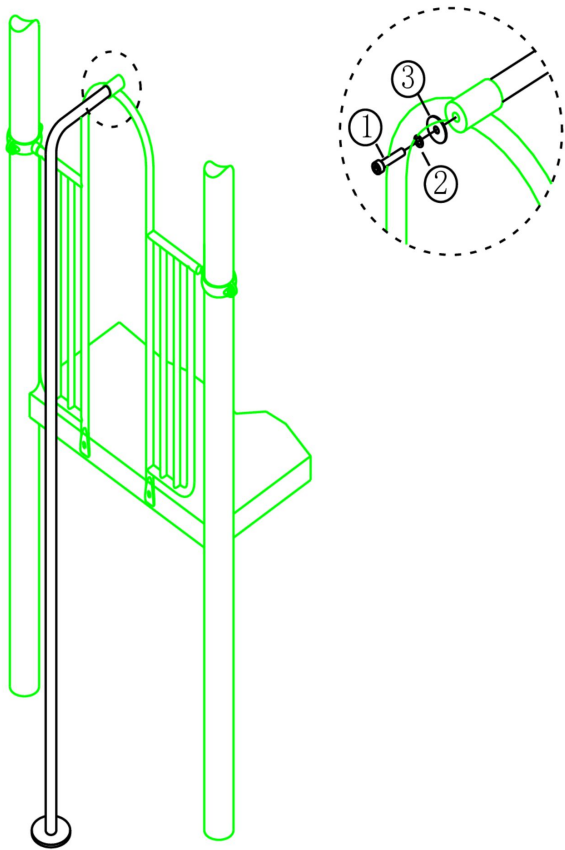









Bevestigings materiaal is per zakje verpakt en bovenstaande afbeelding zit in het zakje

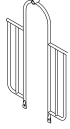

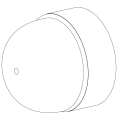
## Hekje tbv: B, Pod en Curly Climber

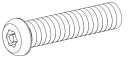
STAP 1 van 1

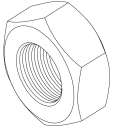
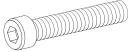
Omschrijving: Bevestiging van het hek tussen de vloer/staander

1 st. Hekje tbv: B, Pod en Curly Climber	2 st. Small clamp + ring	2 st. Afdekdop M10	2 st. Kruiskop M6X65
			① 
4 st. Torx M8X20	4 st. Lock Moer M8	2 st. Lock Moer M6	2 st. Bout M10X25
② 	③ 	④ 	⑤ 
4 st. Ring M10 (middel)	2 st. Lock Moer M10		
⑥ 	⑦ 		

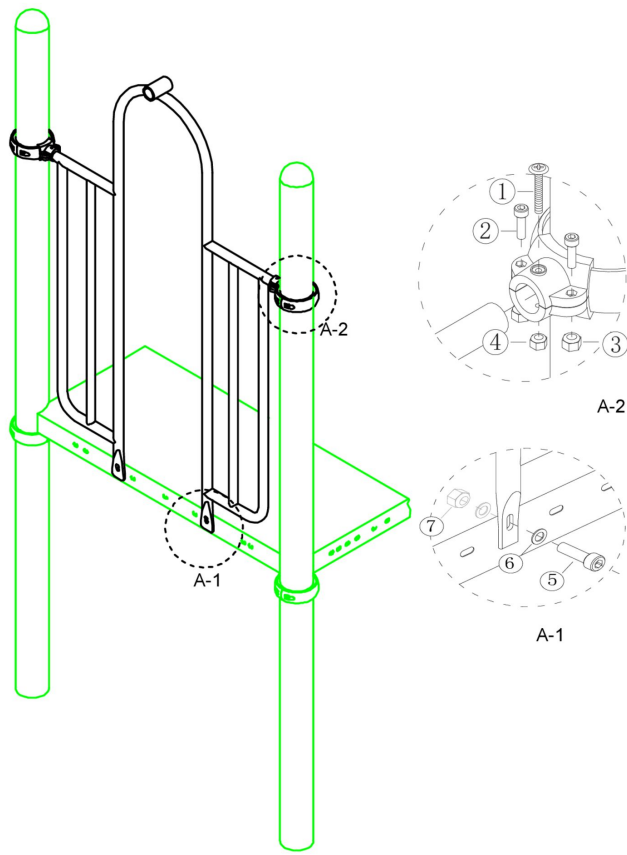

Bevestigings materiaal is per zakje verpakt en bovenstaande afbeelding zit in het zakje

### 120cm B climber

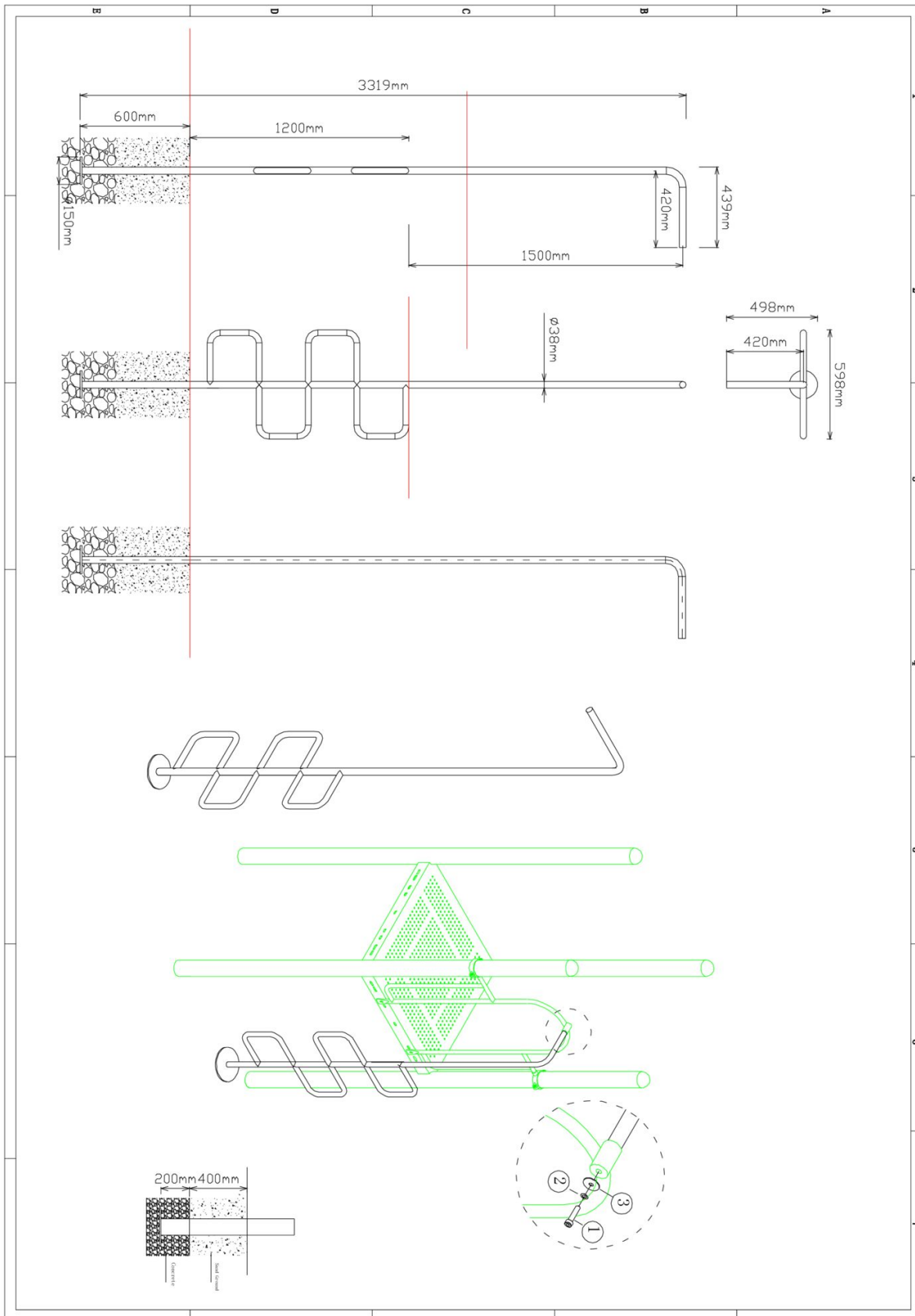

Hoofdafmetingen: 332x44cm



# 120cm B climber

STAP 1 van 1

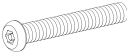
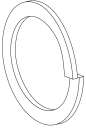
Omschrijving: Bevestiging tussen B-climber en hek

1 st. 120cm B climber	1 st. Torx M10X30	1 st. Veerring M10	1 st. Ring M10 (middel)
			

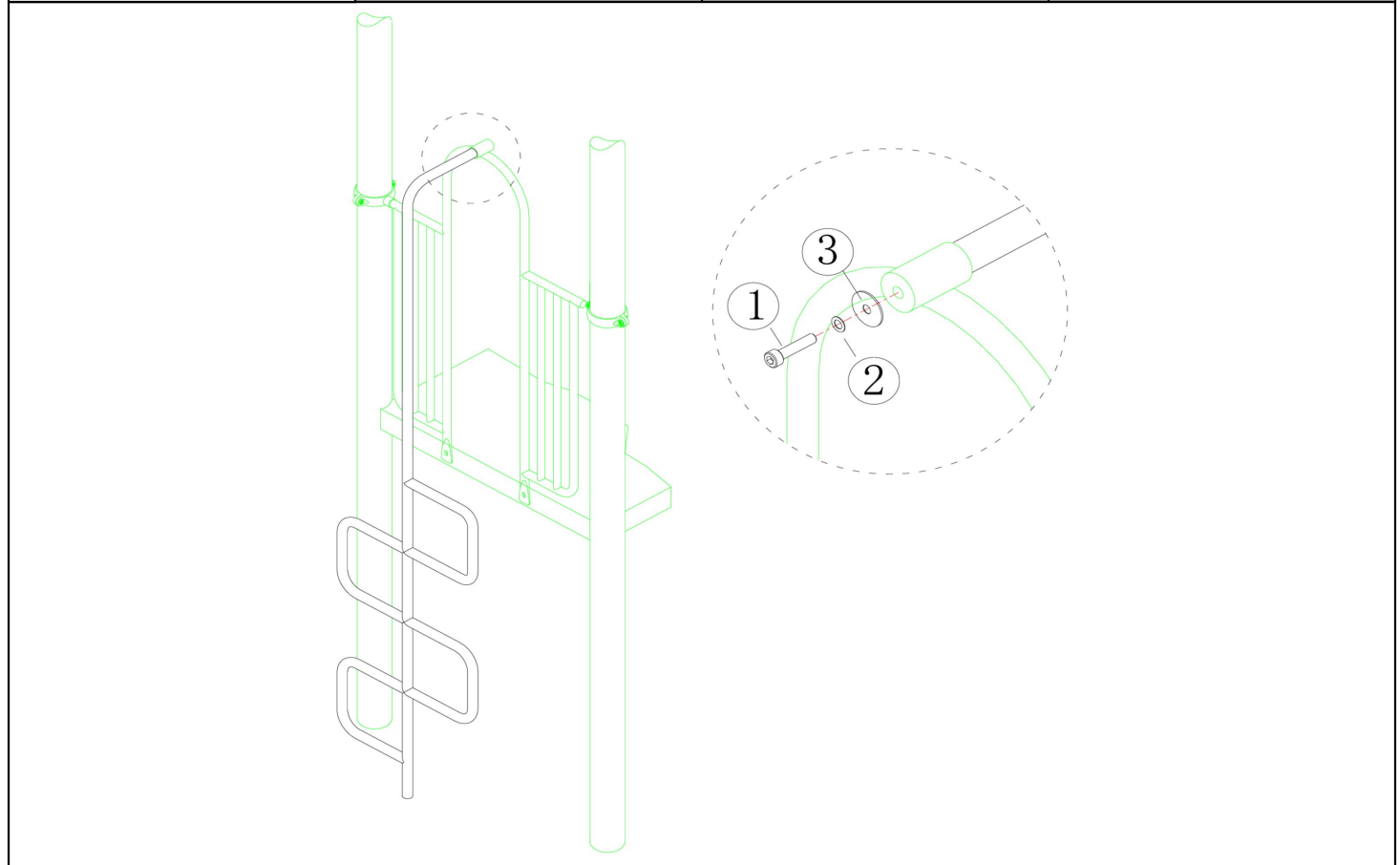

Bevestigings materiaal is per zakje verpakt en bovenstaande afbeelding zit in het zakje

# Hek voor RVS glijbaan



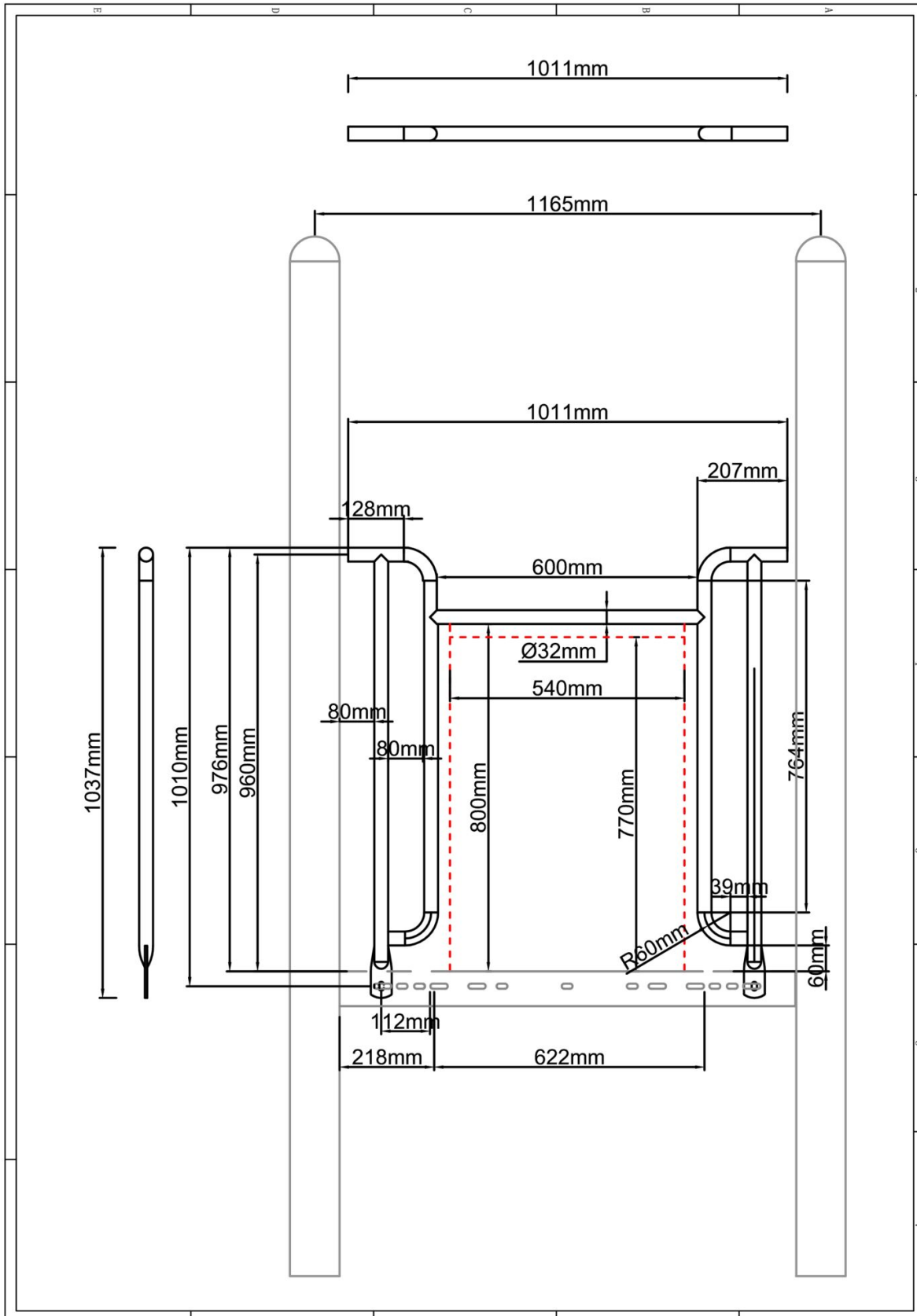

Hoofdafmetingen: 104x101cm

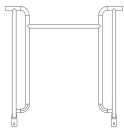

## Hek voor RVS glijbaan

STAP 1 van 1

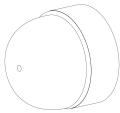
Omschrijving: Bevestiging tussen de vloer/staander en het hekje

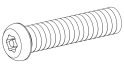
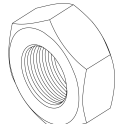
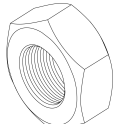
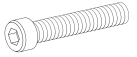
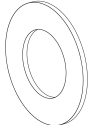
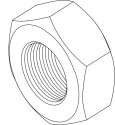
1 st. Hek voor RVS glijbaan	2 st. Small clamp + ring	2 st. Afdekdop M10	2 st. Kruiskop M6X65
			① 
4 st. Torx M8X20	4 st. Lock Moer M8	4 st. Lock Moer M6	2 st. Bout M10X25
② 	③ 	④ 	⑤ 
4 st. Ring M10 (middel)	2 st. Lock Moer M10		
⑥ 	⑦ 		

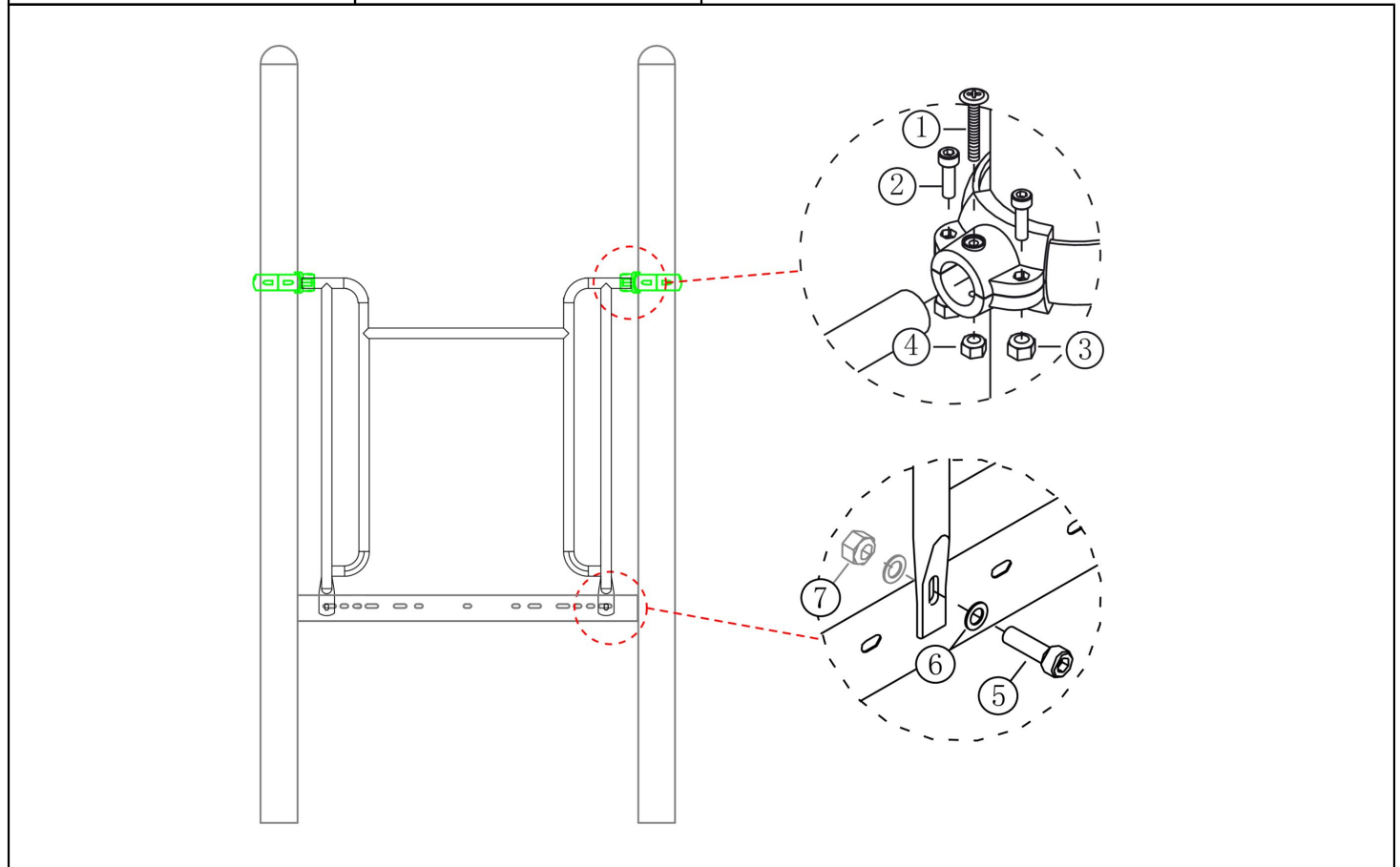

Bevestigings materiaal is per zakje verpakt en bovenstaande afbeelding zit in het zakje

## RVS Glijbaan 120cm

Hoofdafmetingen: 216x257x54cm

alle afmetingen zijn in mm.

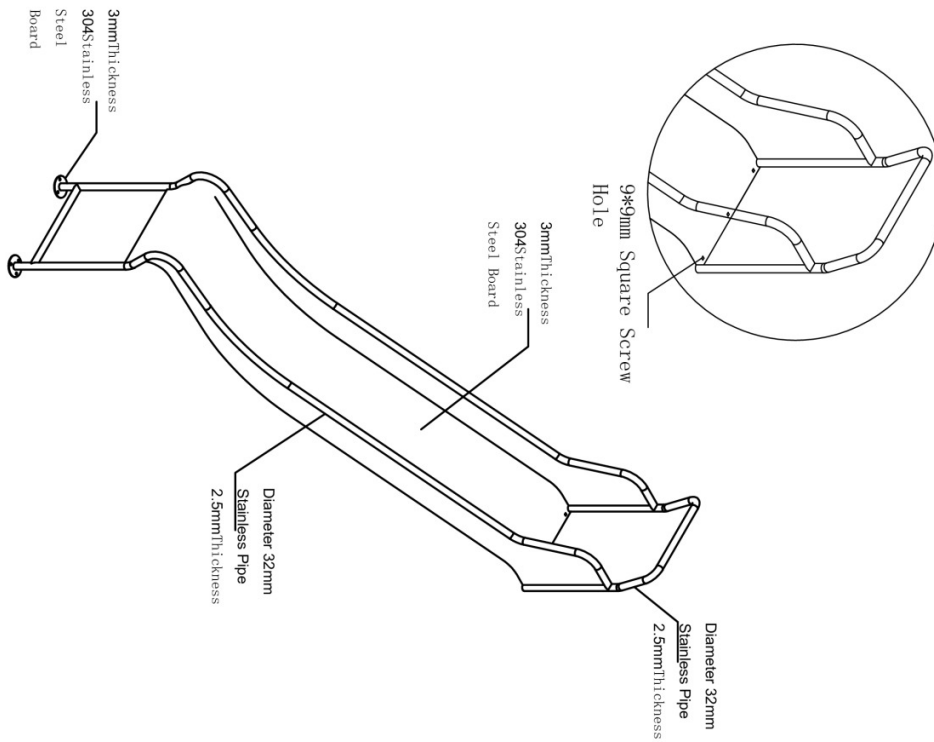
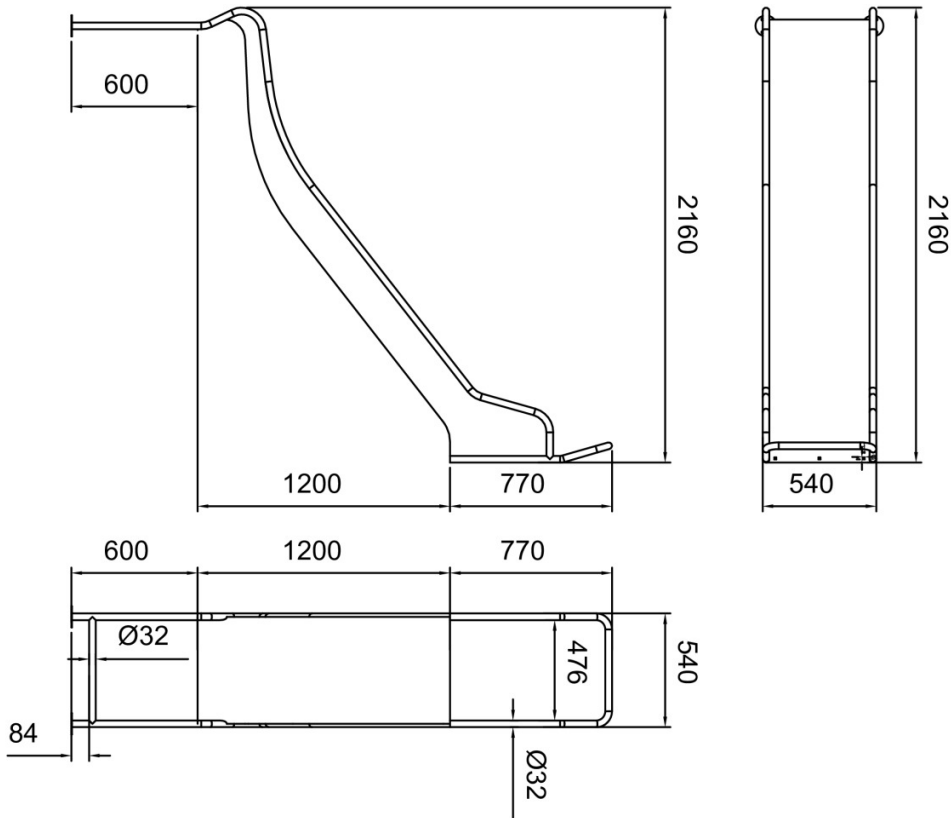



1200mm Slide

# RVS Glijbaan 120cm

STAP 1 van 2

Omschrijving: Bevestigings gaten in de vloer boren volgens schema

1 st. Boormachine	1 st. Boortje 8,5mm
	

1

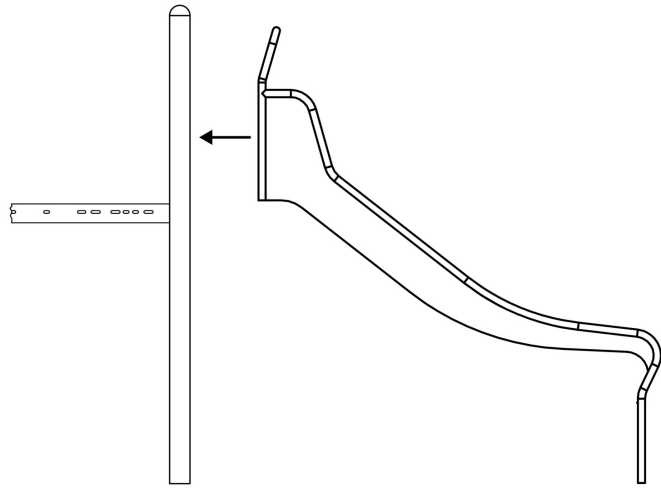

Schema bovenaanzicht

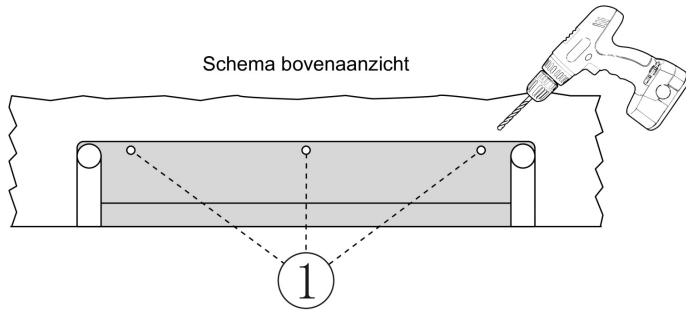

Bevestigings materiaal is per zakje verpakt en bovenstaande afbeelding zit in het zakje

## RVS Glijbaan 120cm

STAP 2 van 2

Omschrijving: Glijbaan op de vloer bevestigen met bijgeleverde montagepakket.

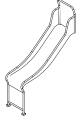
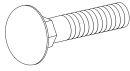
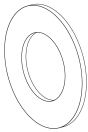
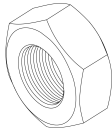
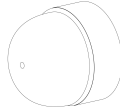
1 st. RVS Glijbaan 120cm	3 st. Slotbout M8X20	
		
3 st. Ring M8 (middel)	3 st. Lock Moer M8	3 st. Afdekdop M8
		

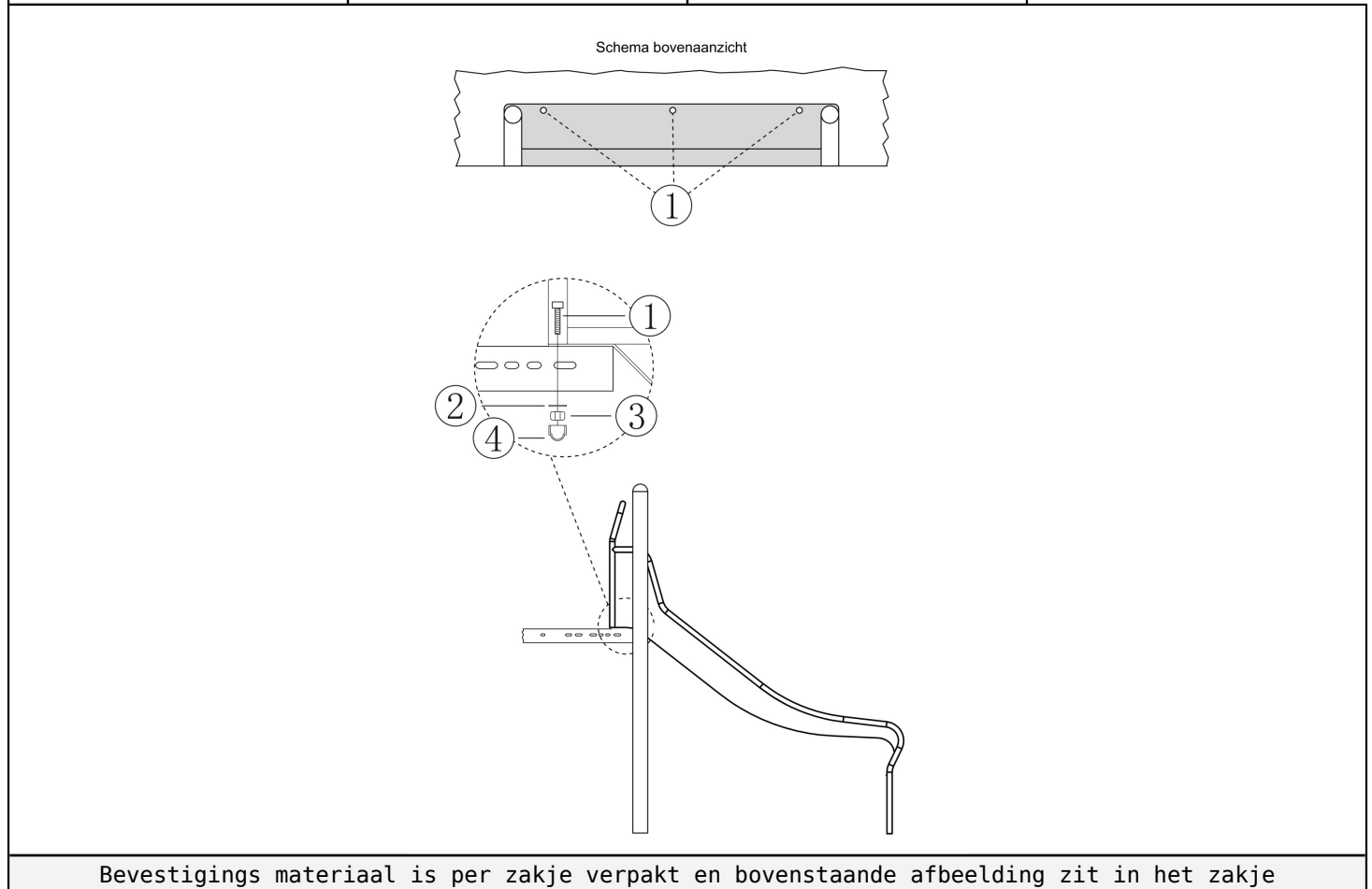

# Bankje 2.0

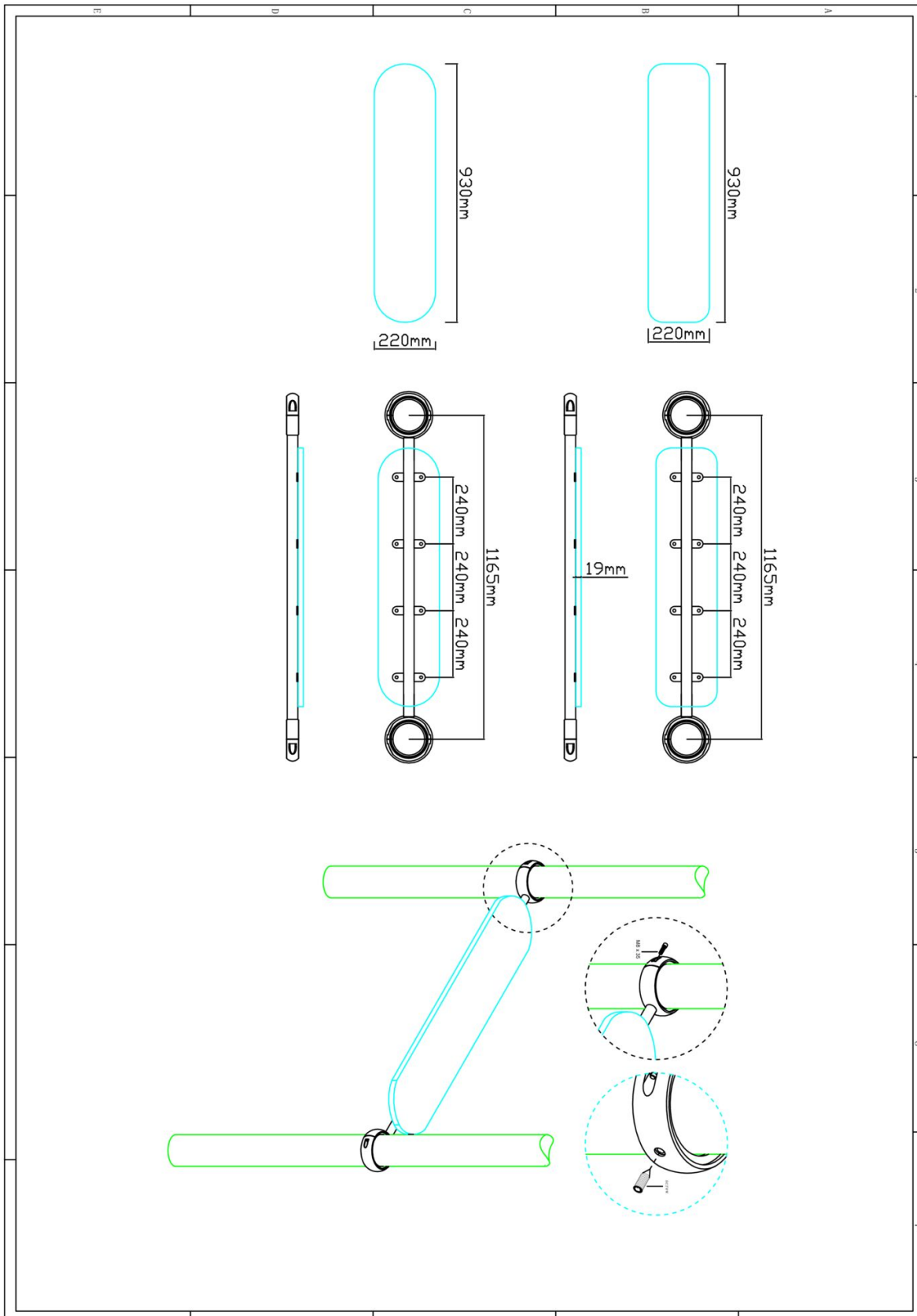

Hoofdafmetingen: 116x22x4cm



# Bankje 2.0

STAP 1 van 1

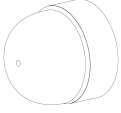
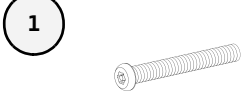
Omschrijving: Bevestiging tussen de standers en de bank

1 st. Bankje 2.0	8 st. Afdekdop M8	4 st. Torx M8X35	2 st. Inbus stelschroef M10x20
			

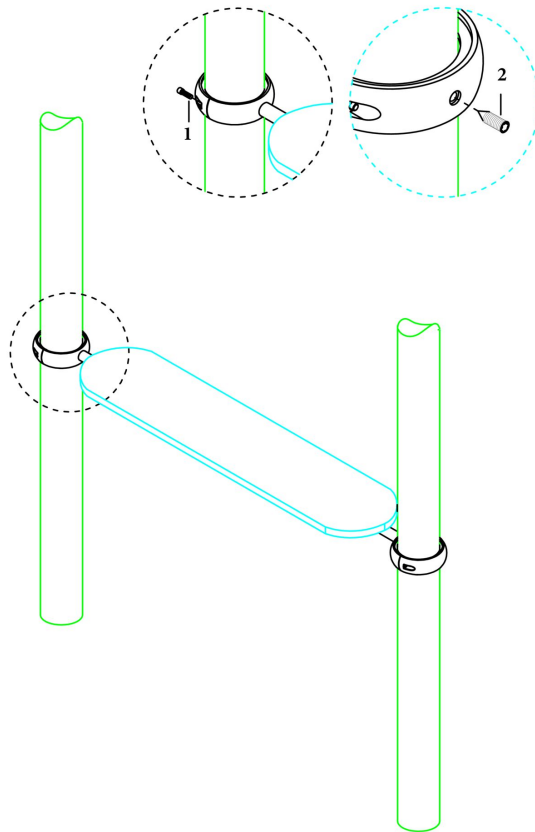

Bevestigings materiaal is per zakje verpakt en bovenstaande afbeelding zit in het zakje