

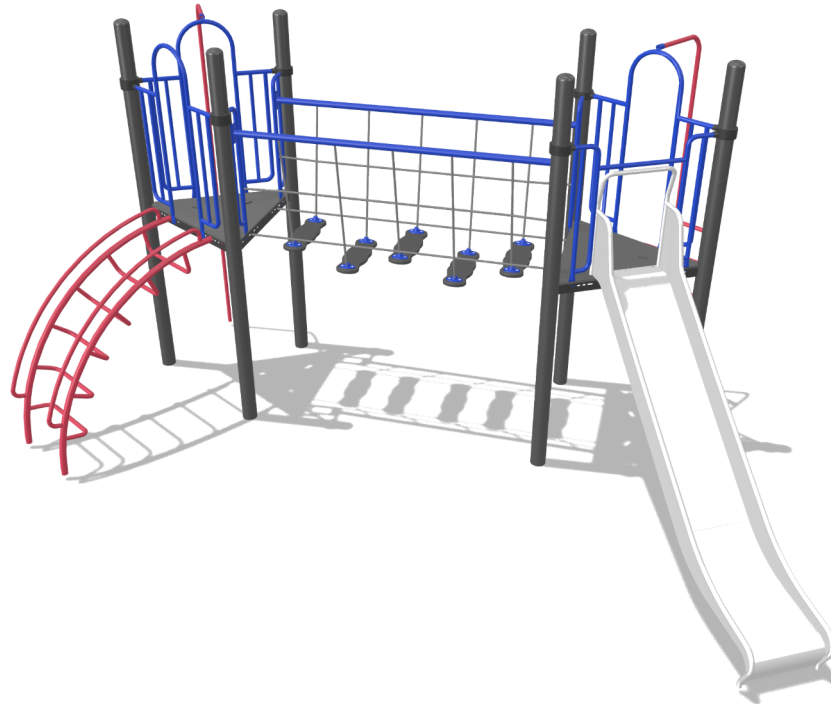

TnT speeltoestellen

Montagehandleiding

3do-481



Toestel	3do-481
Datum montagehandleiding	21-05-2026

Beste klant van TnT Speeltoestellen,

Wij danken u voor het aanschaffen en installeren van een speeltoestel van TnT Speeltoestellen. Wij waarderen het vertrouwen dat u in ons bedrijf heeft geplaatst en streven ernaar om uw vertrouwen meer dan waar te maken!

Dit is uw TnT speeltoestellen montagehandleiding.

Wij hebben deze handleiding specifiek voor het product ontworpen, waarop eveneens de toe te passen onderdelen zijn genoemd.

Ook vindt u het grondplan met de benodigde valruimte volgens norm NEN-EN1176-1 : 2017.

Bewaart u dit document bij uw logboek. Nogmaals willen wij u bedanken voor de aankoop van dit speeltoestel. Wij zien uit naar uw volgende speelproject.

Met vriendelijke groet, TnT Speeltoestellen

Inhoudsopgave

Aanzichten 3D	2
Onderdelenlijst	4
Veiligheidsruimtes	5
Zijaanzichten	6
Plattegrond palenplan	8
Paalmaten	9
Paaldata	10
Onderdeel handleidingen	11
Staander 350cm	12
Vloer gelijke driehoek (vloer_driehoek_gelijk)	14
Stappenbrug lang (brug_stappen_lang)	16
Glijstang (glijstang_150cm)	24
Opgang slang (b-klimmer_150cm)	28
Half ronde opgang (klimrek_150cm_boog)	32
Glijbaan RVS (glijbaan_150cm_metaal)	36

Aanzichten 3D

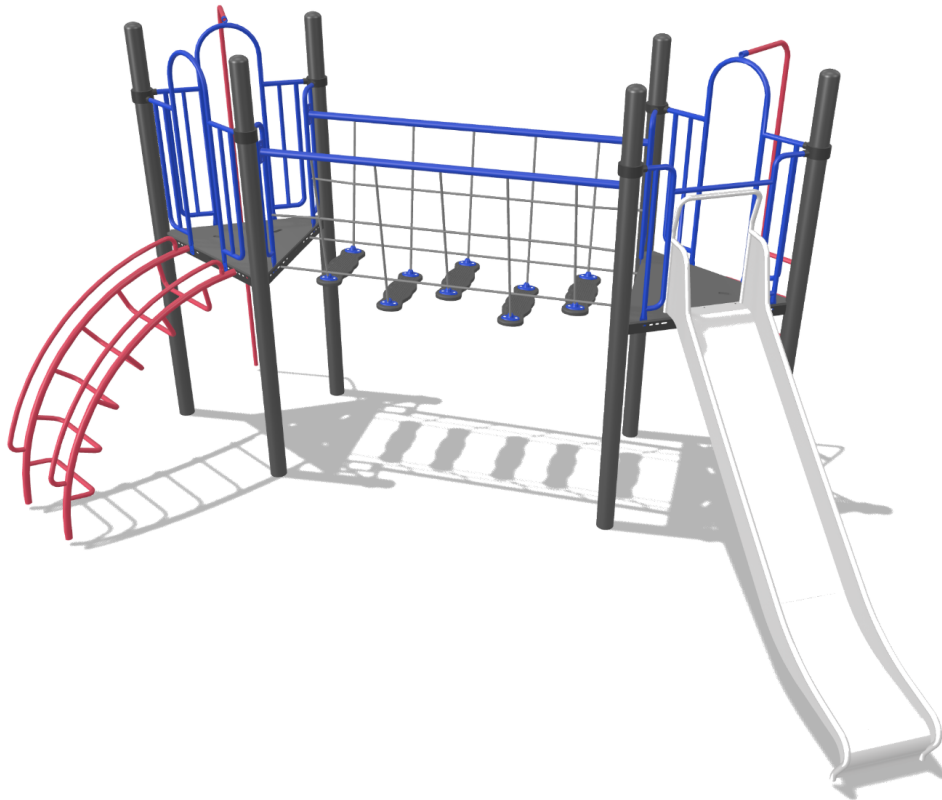

Aanzicht 1

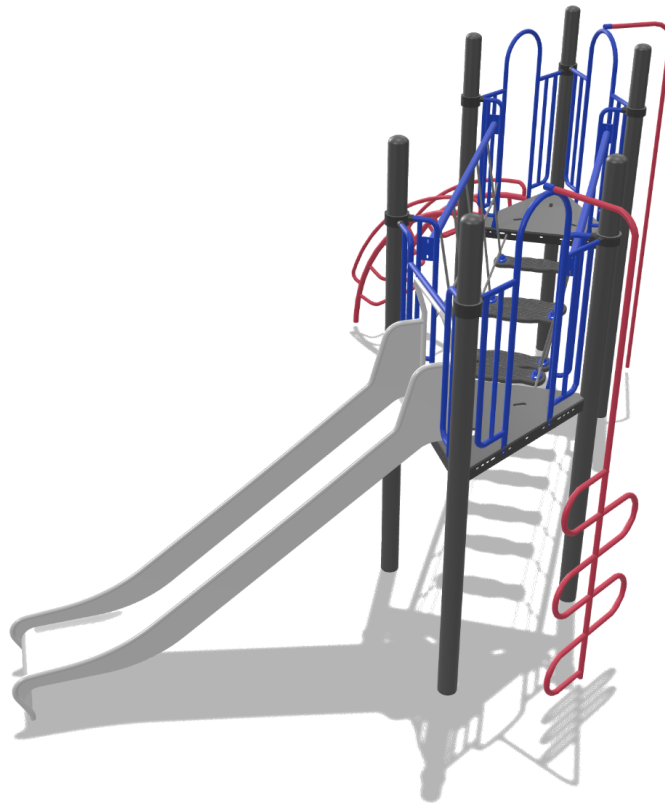

Aanzicht 2

Aanzichten 3D

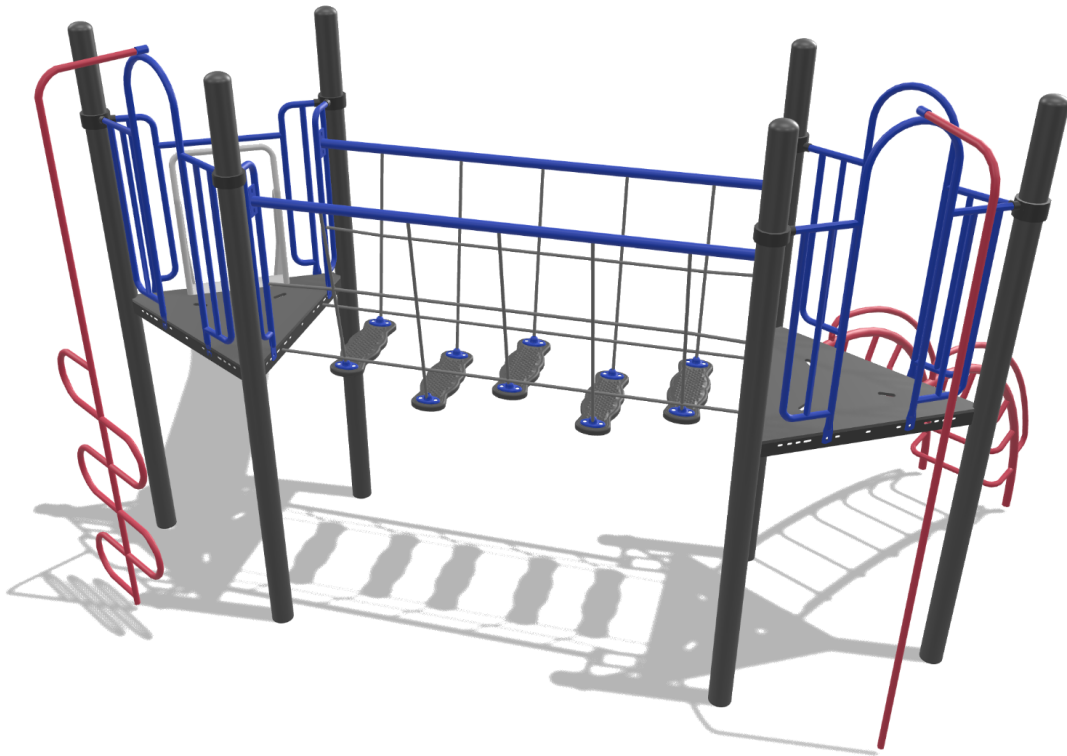



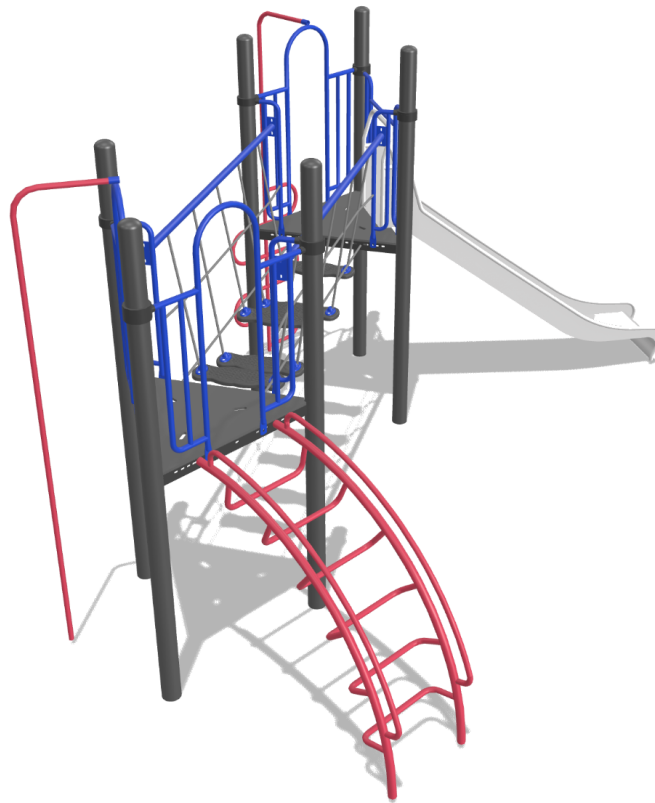

Aanzicht 3

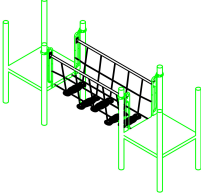
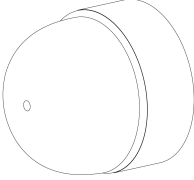
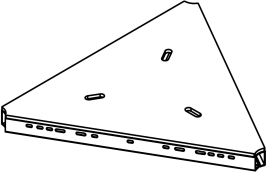
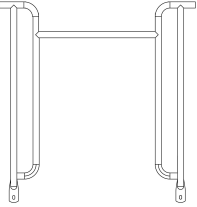
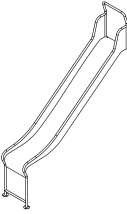
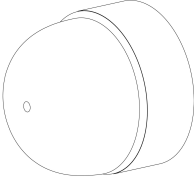
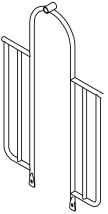

Aanzicht 4

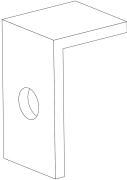
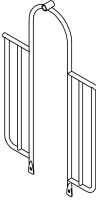
Onderdelenlijst

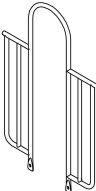
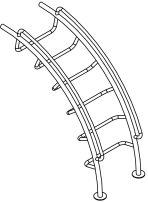
<p>6x Staander 350cm 350x11,5cm</p> 	<p>1x 5-Stappenbrug vernieuwd model 233x105x100cm</p> 	<p>66x Afdekdop M10 M10</p> 	<p>2x Vloer gelijke driehoek HPL 116,5x1165,5x8,5cm</p> 
<p>1x Hek voor RVS glijbaan 104x101cm</p> 	<p>1x RVS Glijbaan 150cm 250x297x54cm</p> 	<p>2x Afdekdop M8 M8</p> 	<p>1x Hekje tbv glijstang 152x101cm</p> 
<p>1x 150cm Glijstang 362x42cm</p> 	<p>2x Hoekje</p> 	<p>1x Hekje tbv: B, Pod en Curly Climber 152x101cm</p> 	<p>1x 150cm B climber 362x44cm</p> 
<p>1x Hekje zonder bevestiging (boven) 152x101cm</p> 	<p>1x 150cm Arch climber 217x150x73cm</p> 		

Veiligheidsruimtes

Geachte klant,

Zorg er altijd voor dat alle veiligheidsruimtes zoals aangegeven in ieder geval gehaald worden, dit zijn de minimale vereiste ruimtes voor een veilig gebruik van het speeltoestel.

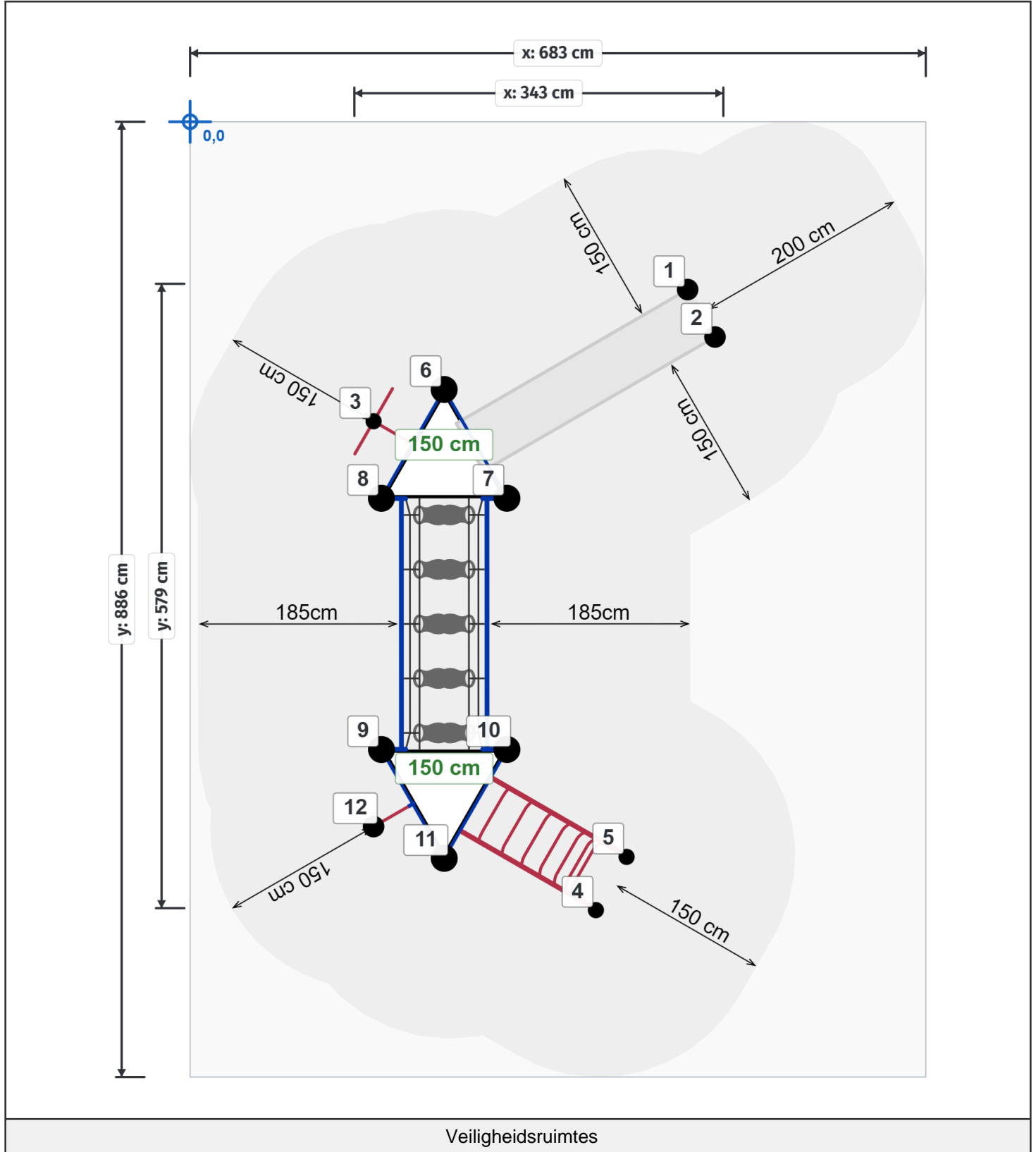

Zijaanzichten

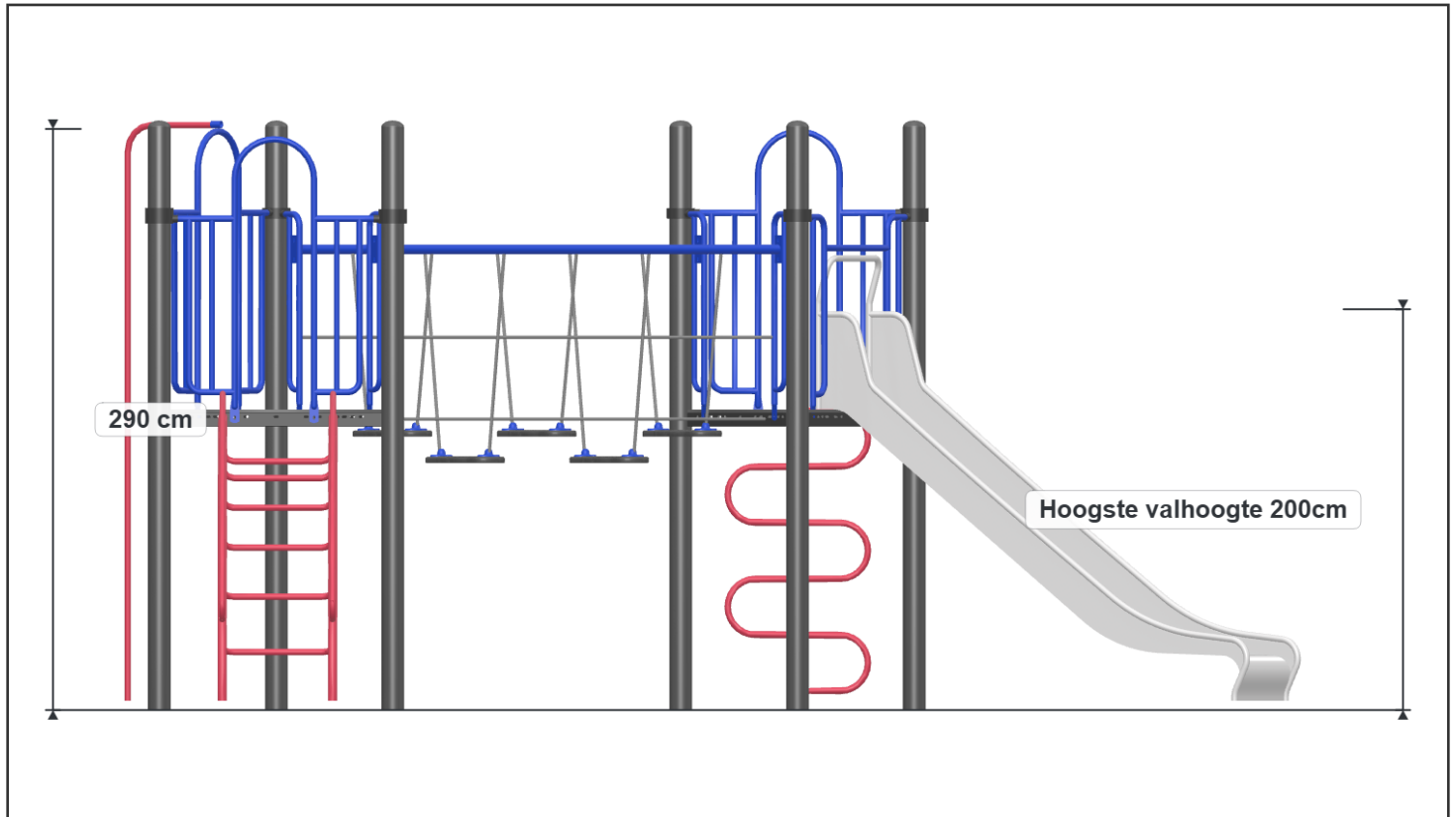

Aanzicht 1



Aanzicht 2

Zijaanzichten

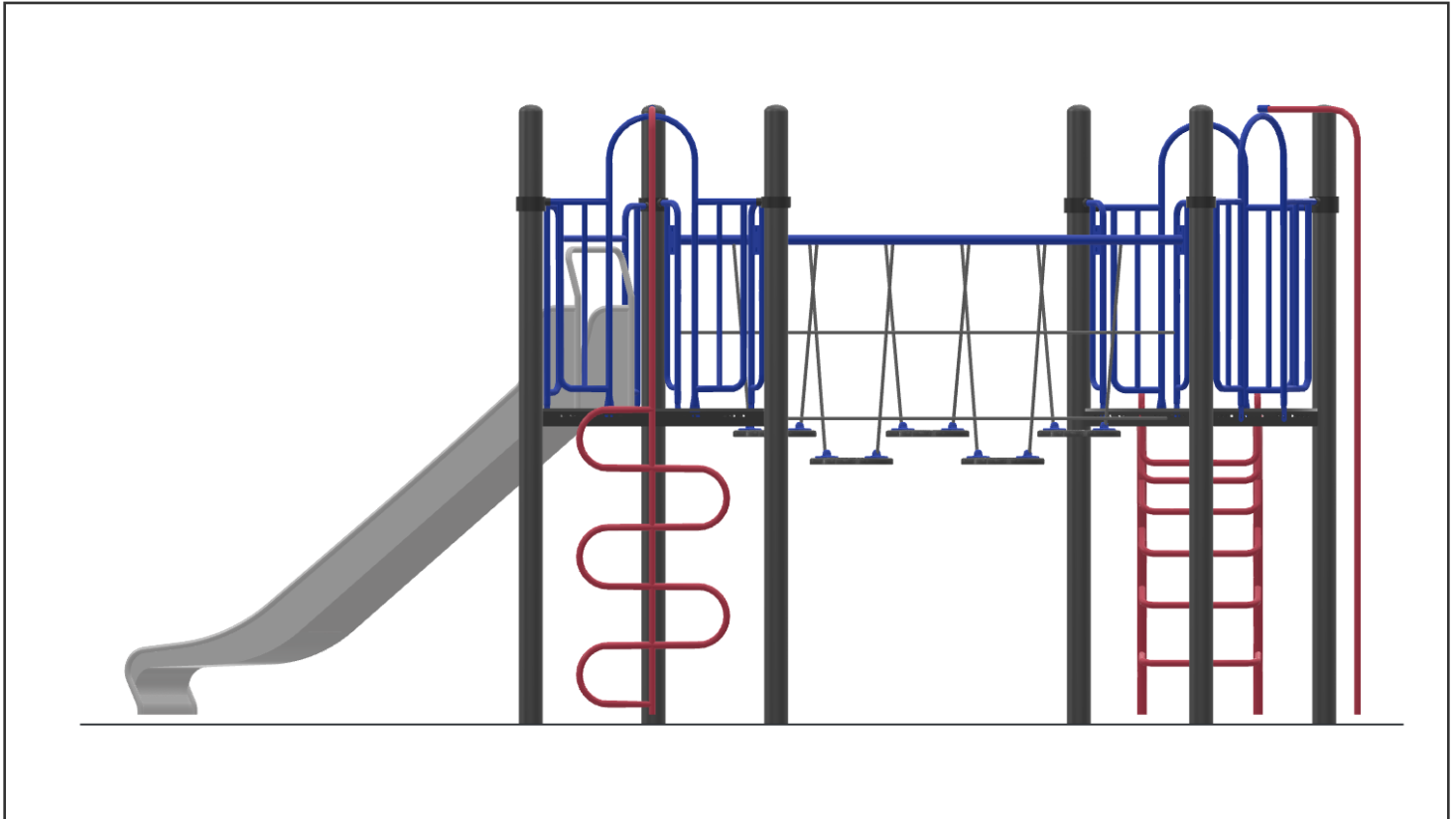

Aanzicht 3

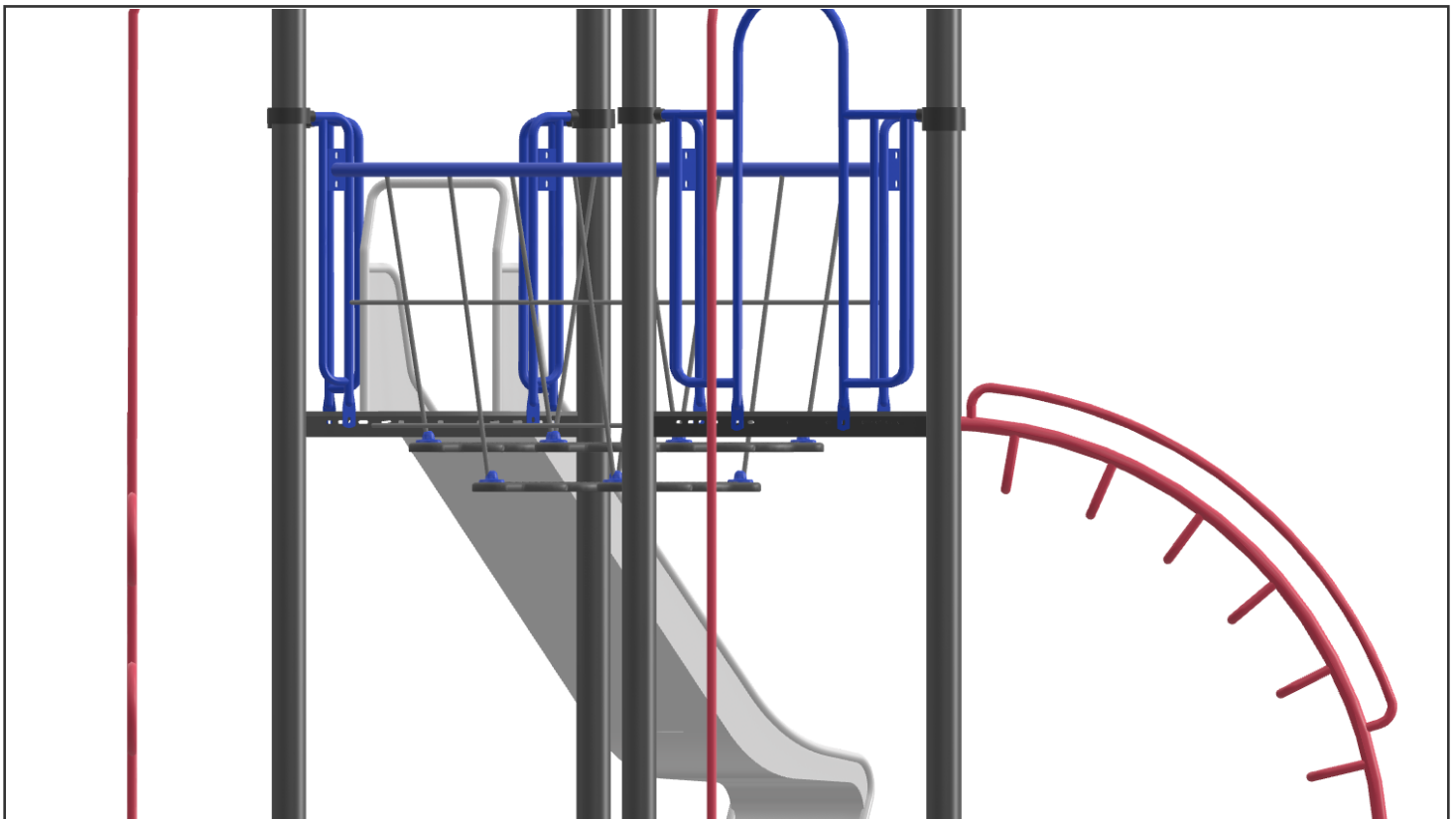

Aanzicht 4

Plattegrond palenplan

U kunt van deze tekening niet afmeten!

Voor de betonfundatie heeft u 37,5 kg snelbeton per staander nodig.

Voor de overige onderdelen (Glijstangen, Climbers, Glijbaan voeten) 25 kg snelbeton.

Houdt u er rekening mee dat de betonfundatie minimaal 400mm onder het maaiveld blijft, zoals op de tekening afgebeeld.

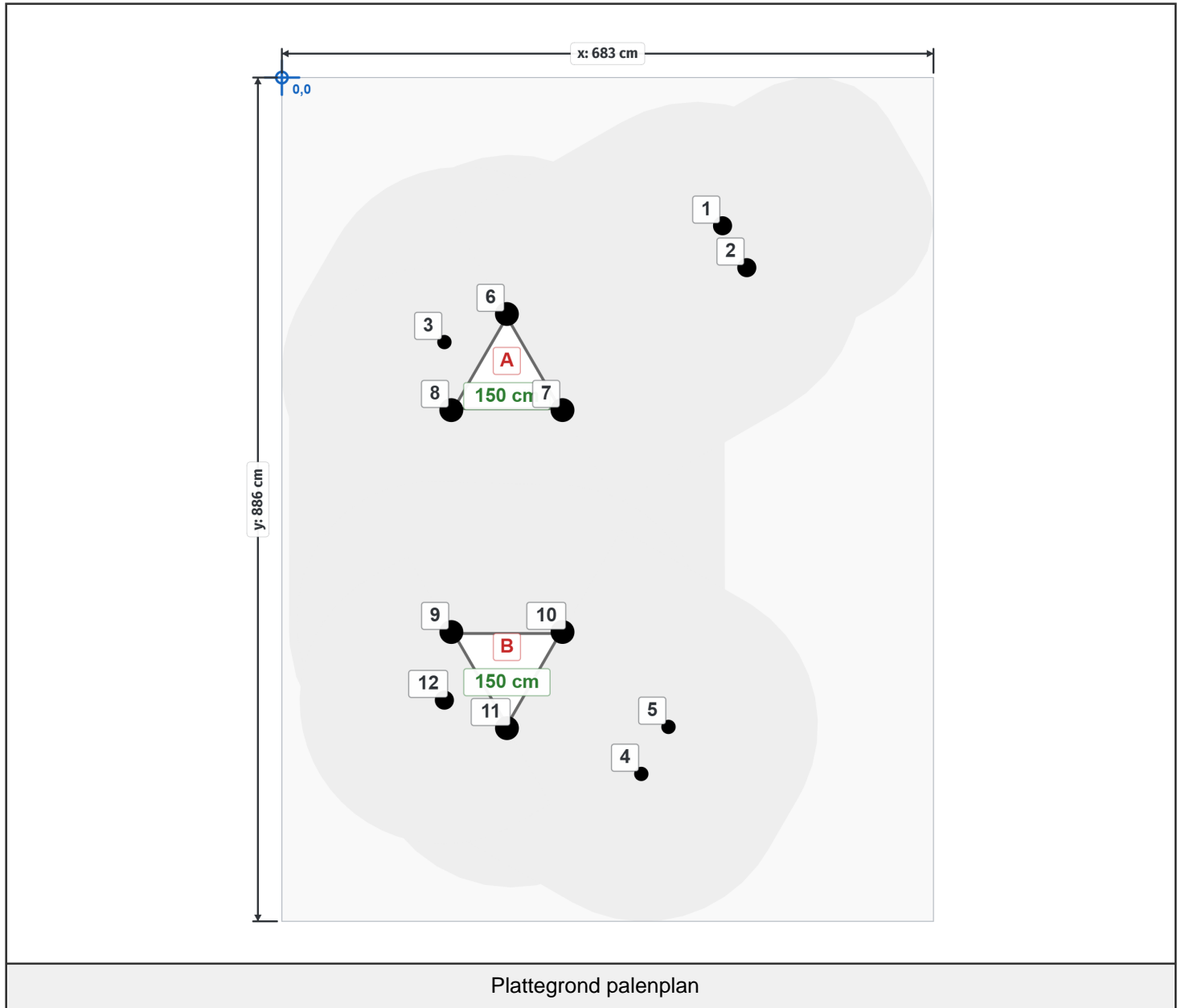

Plattegrond palenplan

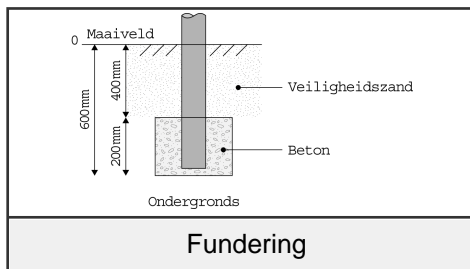

Fundering

Paalmaten

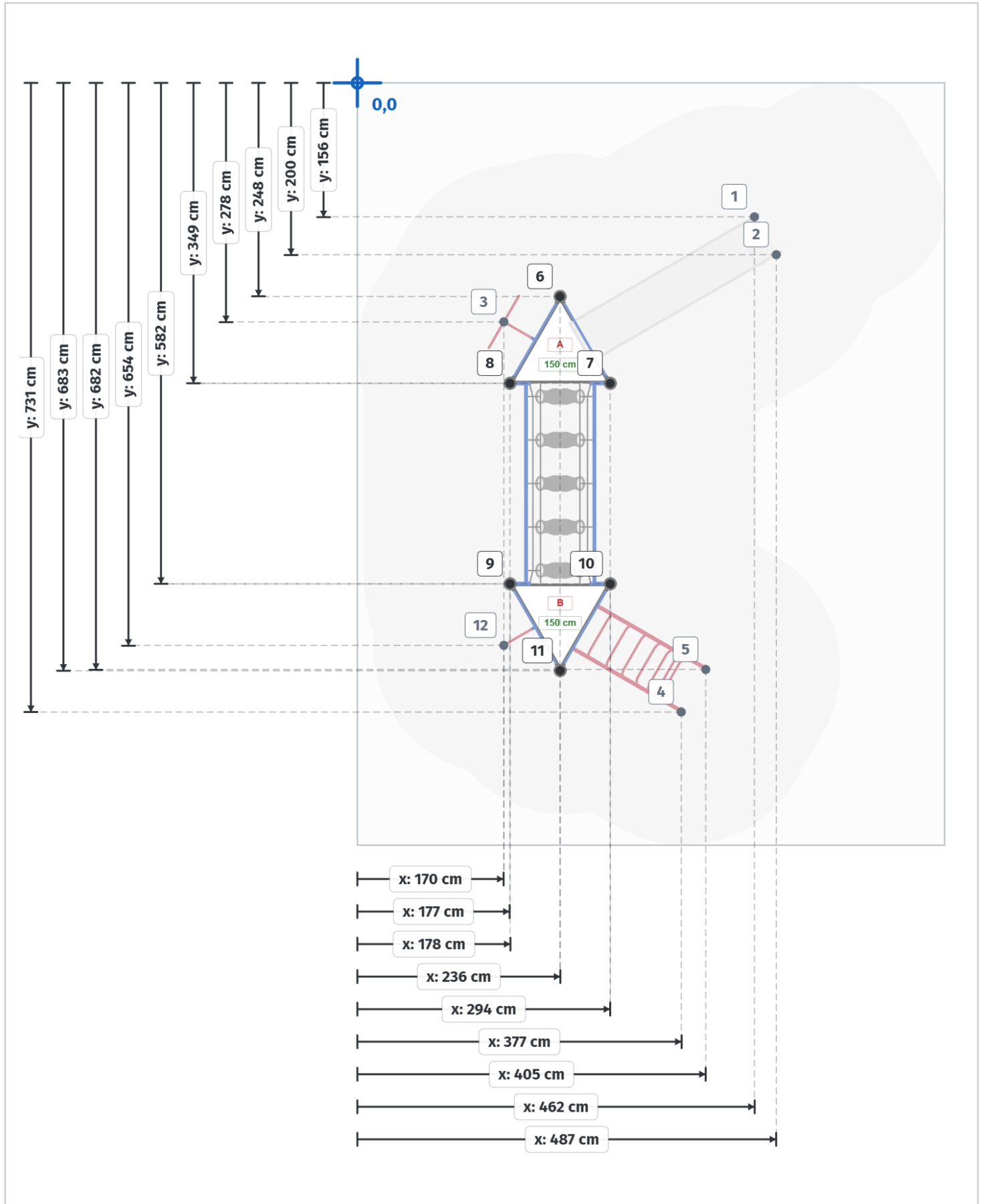

Paaldata

Staanders			
Label	X	Y	Hoogte
1	462 cm	156 cm	0 cm
2	488 cm	200 cm	0 cm
3	171 cm	278 cm	0 cm
4	377 cm	731 cm	0 cm
5	406 cm	682 cm	0 cm
6	236 cm	249 cm	350 cm
7	294 cm	350 cm	350 cm
8	178 cm	350 cm	350 cm
9	178 cm	583 cm	350 cm
10	295 cm	583 cm	350 cm
11	236 cm	684 cm	350 cm
12	171 cm	654 cm	0 cm

Vloeren	
Label	Hoogte
A	150 cm
B	150 cm

Onderdeel handleidingen

Op de volgende pagina's van dit document vindt u alle individuele onderdelen met bijbehorende technische tekeningen en eventuele montage instructies.

Staander 350cm

Hoofdafmetingen: 350x11,5cm

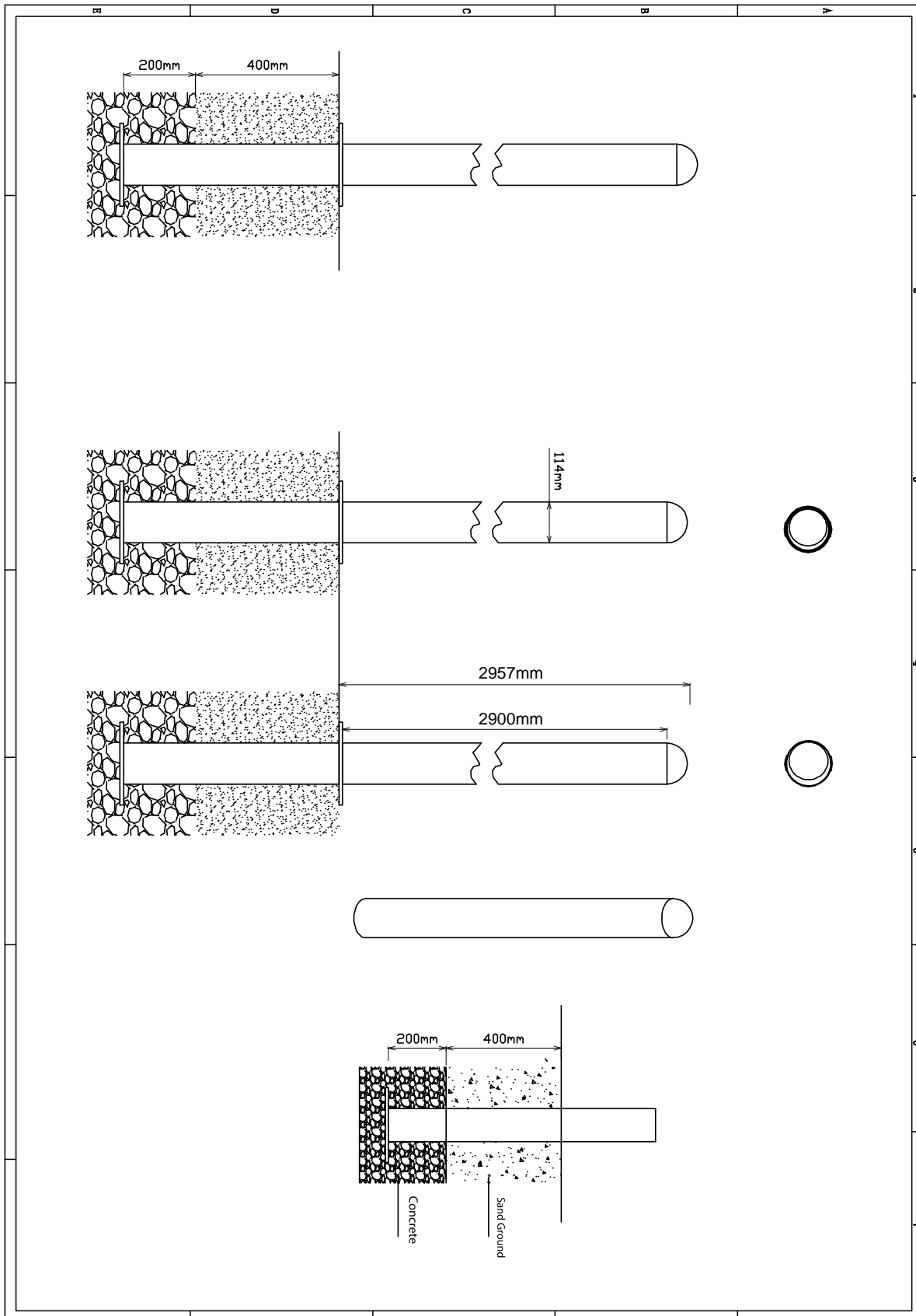

Staander

STAP 1 van 1

Omschrijving: Paalkap losdraaien en opnieuw bevestigen met loctite op het draadeind

1 st. Loctite

1

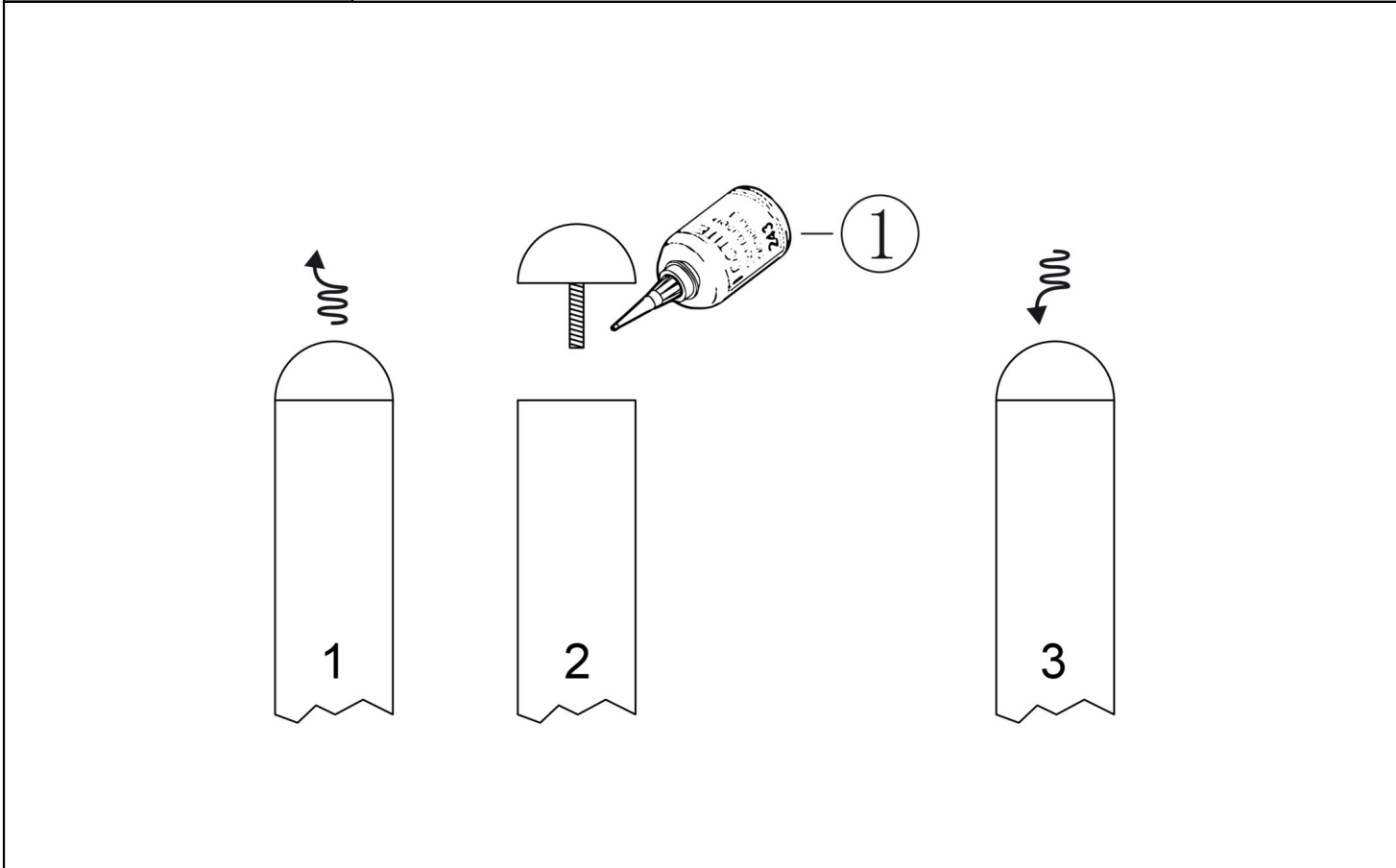

Bevestigings materiaal is per zakje verpakt en bovenstaande afbeelding zit in het zakje

Vloer gelijke driehoek HPL

Hoofdafmetingen: 116,5x1165,5x8,5cm

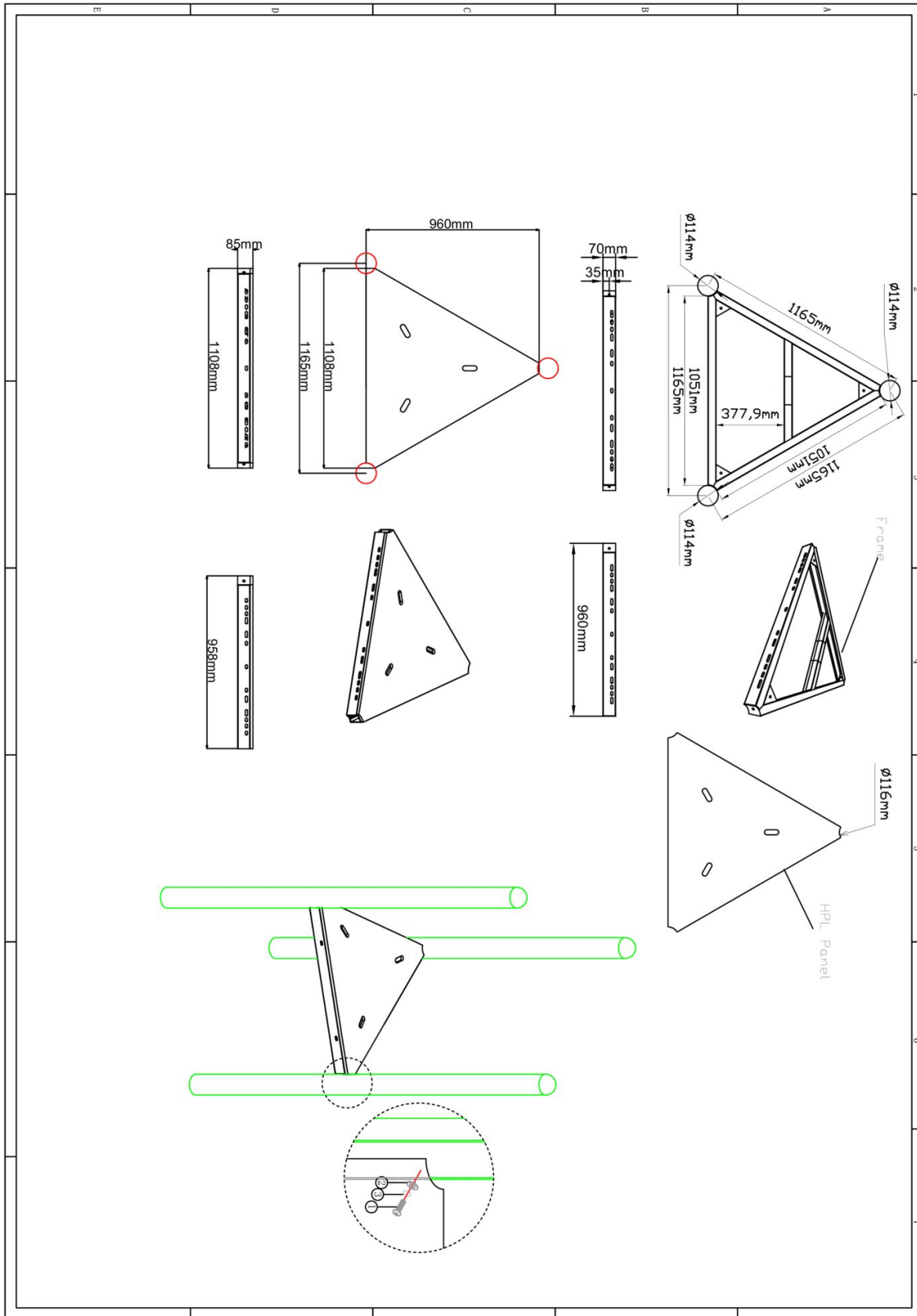

Vloer gelijke driehoek HPL

STAP 1 van 1

Omschrijving: Bevestiging van de vloer aan de staander. In de staander zitten al voor gemonteerde M10 bussen op de juiste hoogte waar de bout ingedraaid dienen te worden.

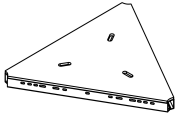
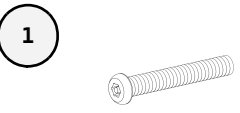
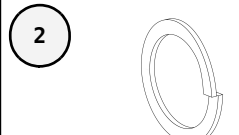
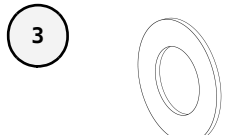
1 st. Vloer gelijke driehoek HPL	3 st. Torx M10X30	3 st. Veerring M10	3 st. Ring M10 (middel)
			

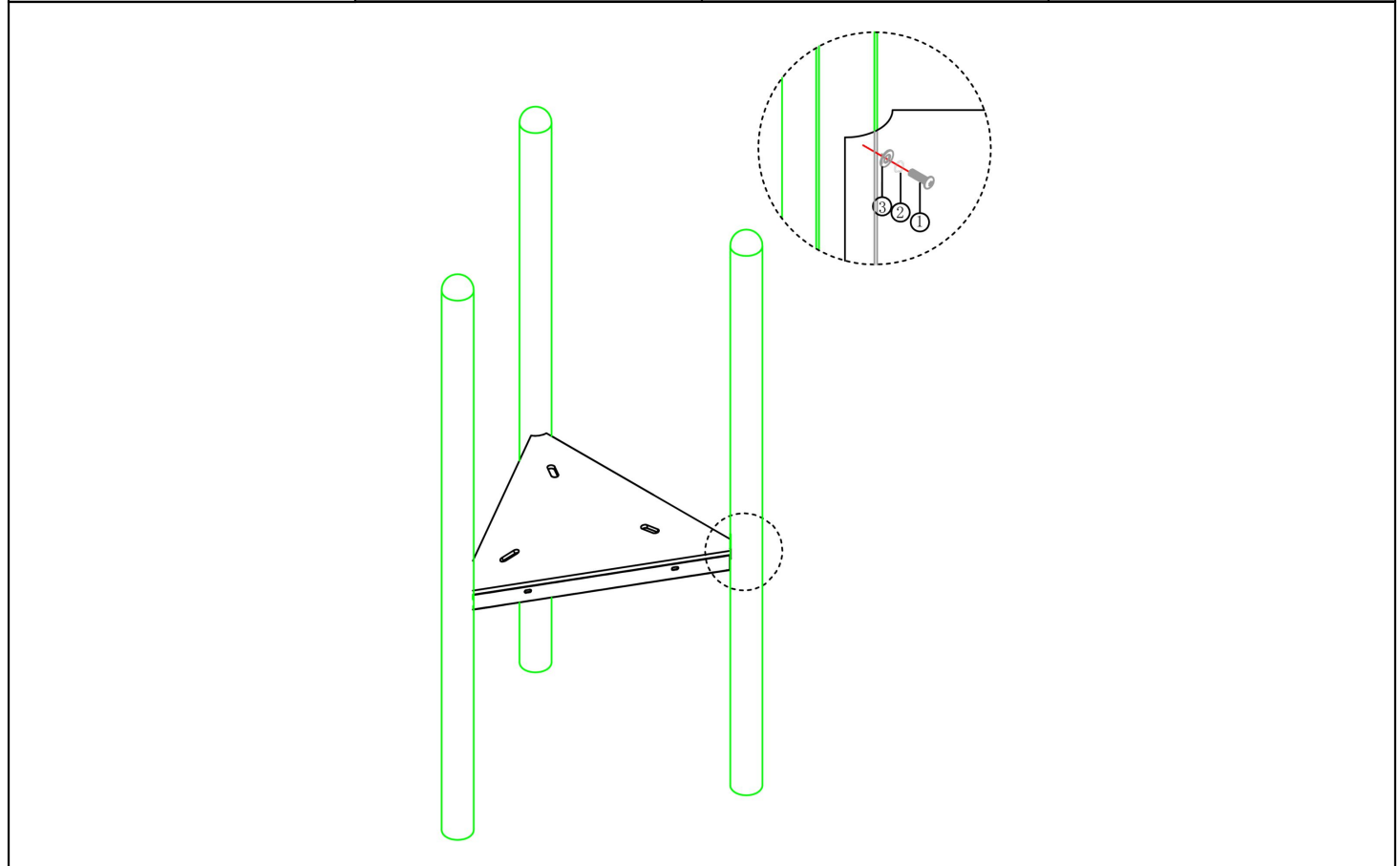

Bevestigings materiaal is per zakje verpakt en bovenstaande afbeelding zit in het zakje

5-Stappenbrug vernieuwd model

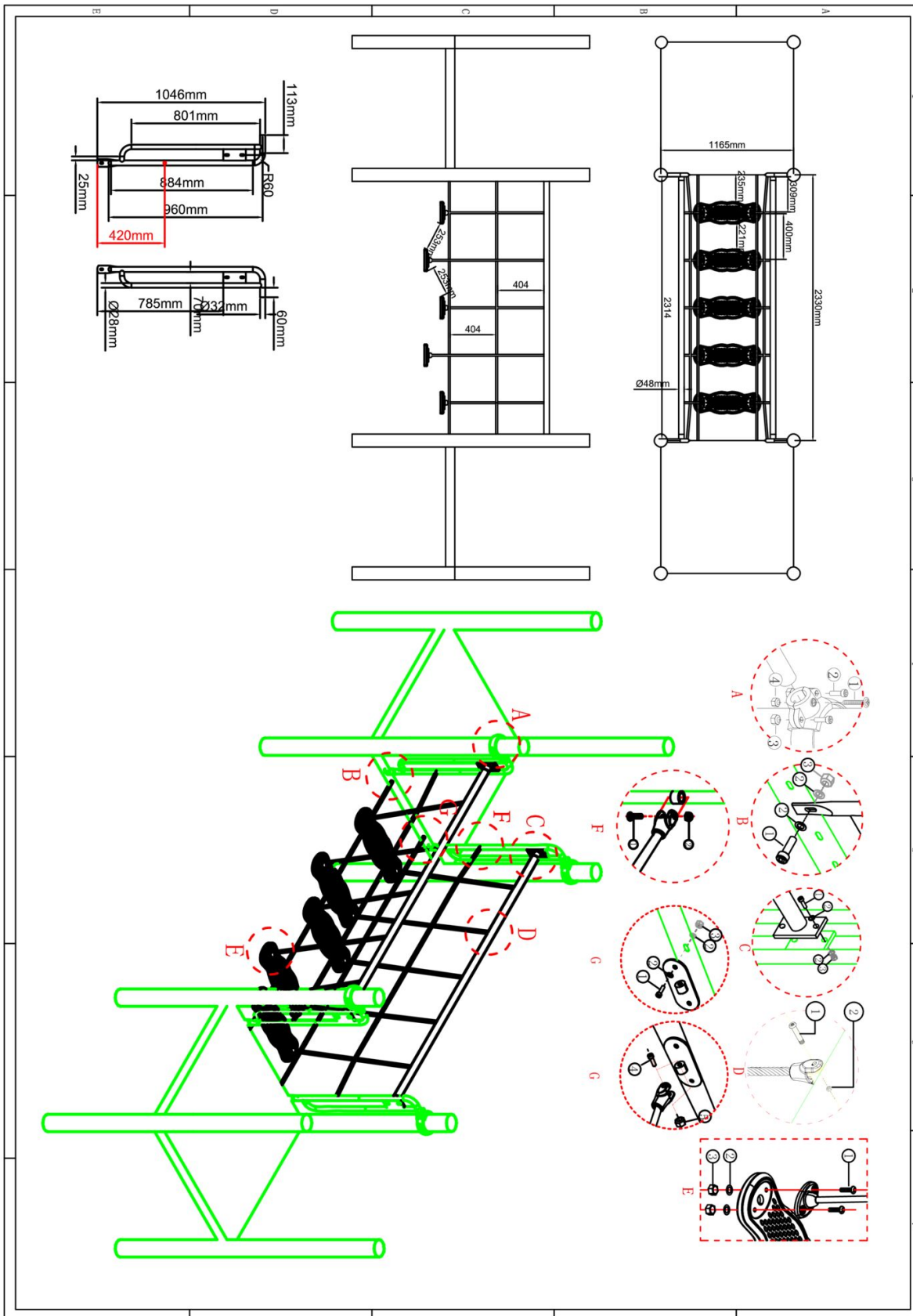

Hoofdafmetingen: 233x105x100cm



5-Stappenbrug vernieuwd model

STAP 1 van 7

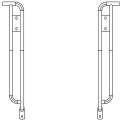
Omschrijving: Bevestiging tussen de hekjes van de brug en de staanders

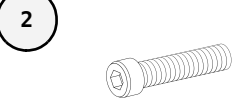
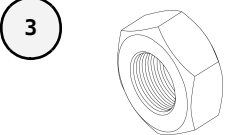
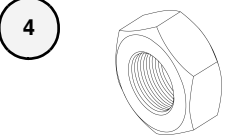
2 st. PE stapbrug Handrail	4 st. Small clamp + ring	4 st. Kruiskop M6X65	8 st. Bout M8X20
			
8 st. Lock Moer M10	4 st. Lock Moer M6		
			

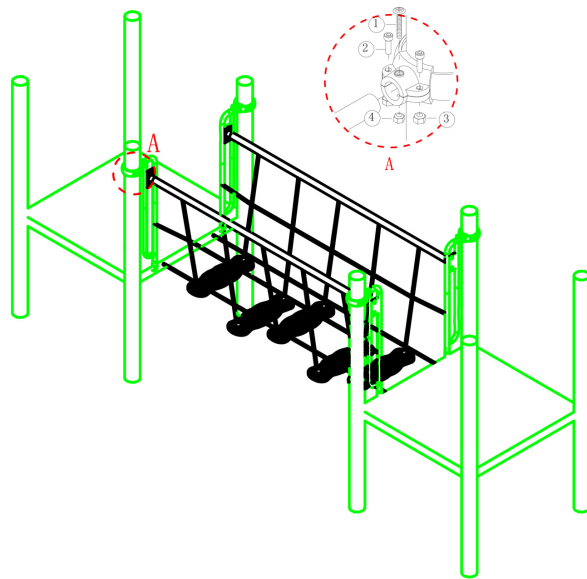

Bevestigings materiaal is per zakje verpakt en bovenstaande afbeelding zit in het zakje

5-Stappenbrug vernieuwd model

STAP 2 van 7

Omschrijving: Bevestiging tussen de hekjes van de brug en de vloer

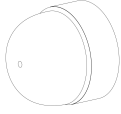
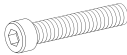
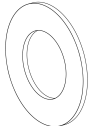
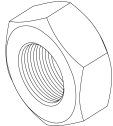
4 st. Afdekdop M10	4 st. Bout M10X25
	1 
8 st. Ring M10 (middel)	4 st. Lock Moer M10
2 	3 

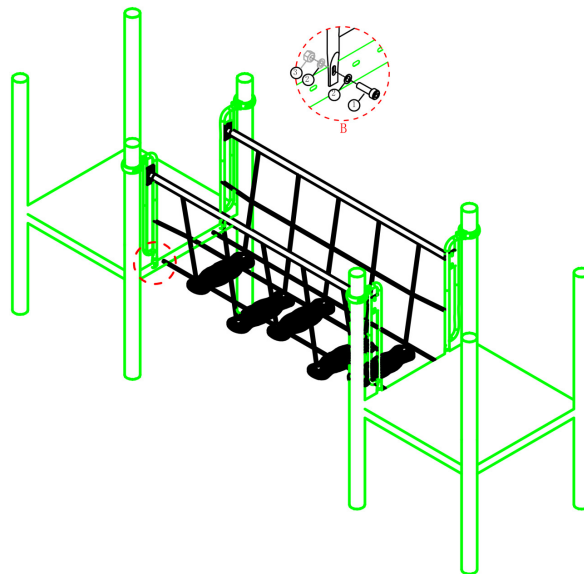

Bevestigings materiaal is per zakje verpakt en bovenstaande afbeelding zit in het zakje

5-Stappenbrug vernieuwd model

STAP 3 van 7

Omschrijving: Bevestiging tussen de brugleuningen en de hekjes

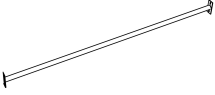
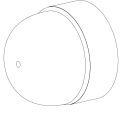
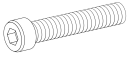
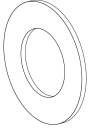
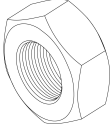
2 st. PE stapbrug leuning	8 st. Afdekdop M10		
			
8 st. Bout M10X25	16 st. Ring M10 (middel)	8 st. Lock Moer M10	
<p>1</p> 	<p>2</p> 	<p>3</p> 	

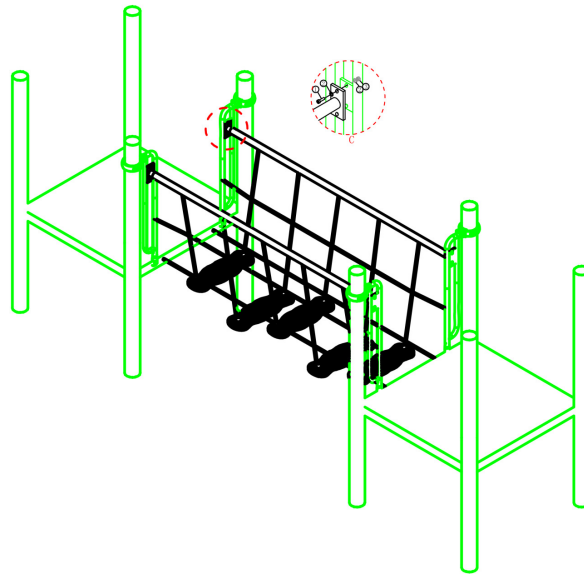

Bevestigings materiaal is per zakje verpakt en bovenstaande afbeelding zit in het zakje

5-Stappenbrug vernieuwd model

STAP 4 van 7

Omschrijving: Bevestiging tussen de brugtouwen en de brugleuningen

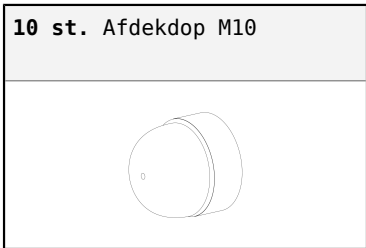

10 st. Bout M10X60

10 st. Lock Moer M10

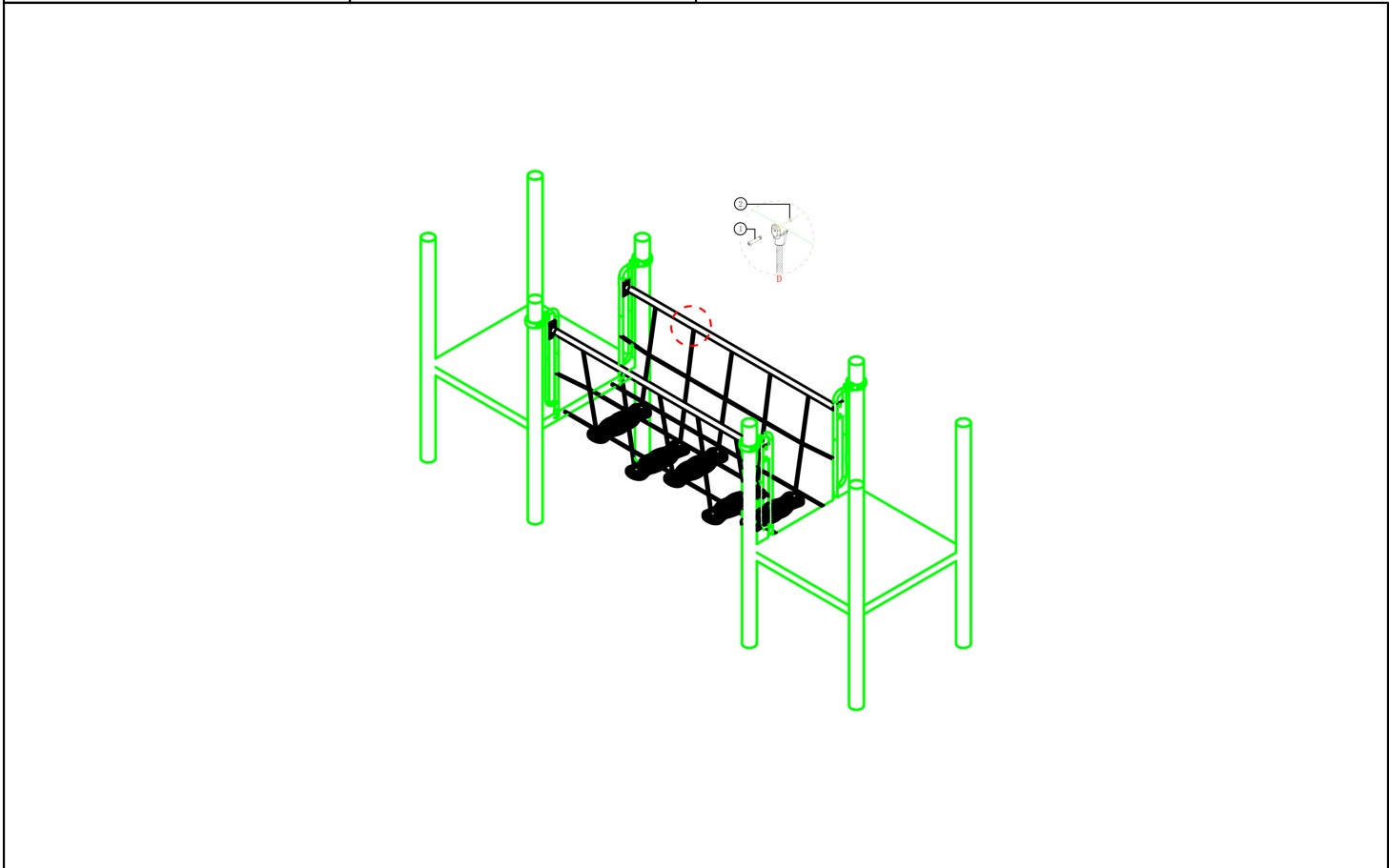
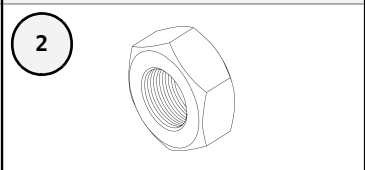
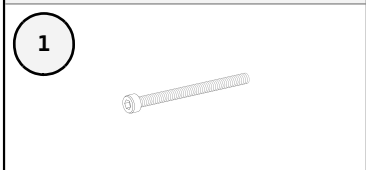



Bevestigings materiaal is per zakje verpakt en bovenstaande afbeelding zit in het zakje

5-Stappenbrug vernieuwd model

STAP 5 van 7

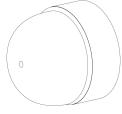
Omschrijving: Bevestiging tussen de stepjes en de brugtouwen

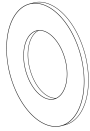
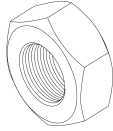
20 st. Afdekdop M10	20 st. Bout M10X60
	1 
20 st. Ring M10 (middel)	20 st. Lock Moer M10
2 	3 

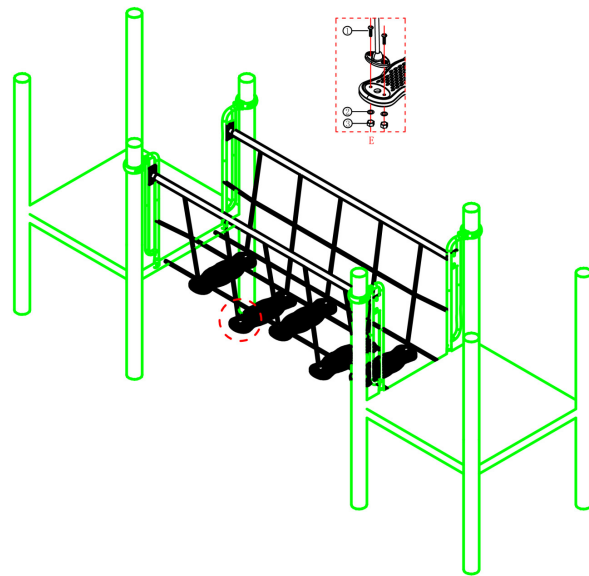



Bevestigings materiaal is per zakje verpakt en bovenstaande afbeelding zit in het zakje

5-Stappenbrug vernieuwd model

STAP 6 van 7

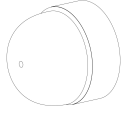
Omschrijving: Bevestiging tussen het hek en de brugtouwen

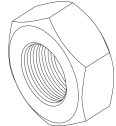
4 st. Afdekdop M10	4 st. Torx M10X60
	1 
4 st. Lock Moer M10	
2 	

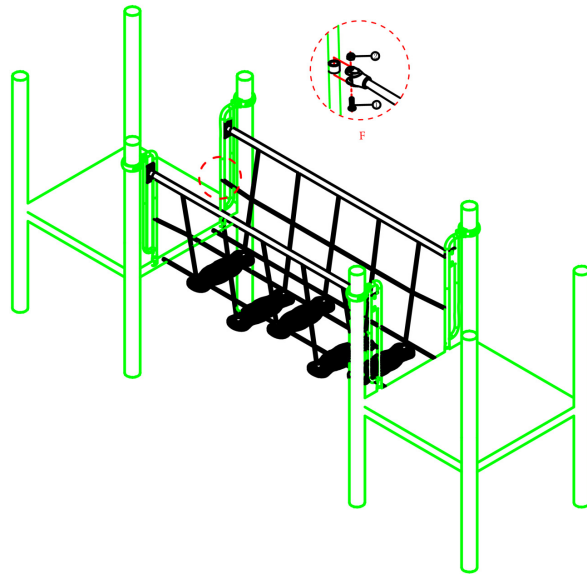



Bevestigings materiaal is per zakje verpakt en bovenstaande afbeelding zit in het zakje

5-Stappenbrug vernieuwd model

STAP 7 van 7

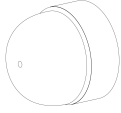
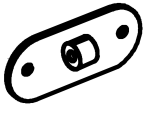
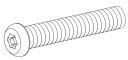
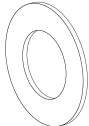
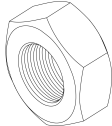
Omschrijving: Bevestiging tussen de vloer en de brugtouwen

12 st. Afdekdop M10	4 st. Connector stappenbrug vloer	8 st. Torx M10X25	
		 1	
16 st. Ring M10 (middel)	4 st. Lock Moer M10	4 st. Torx M10X60	4 st. Lock Moer M10
 2	 3	 4	 5

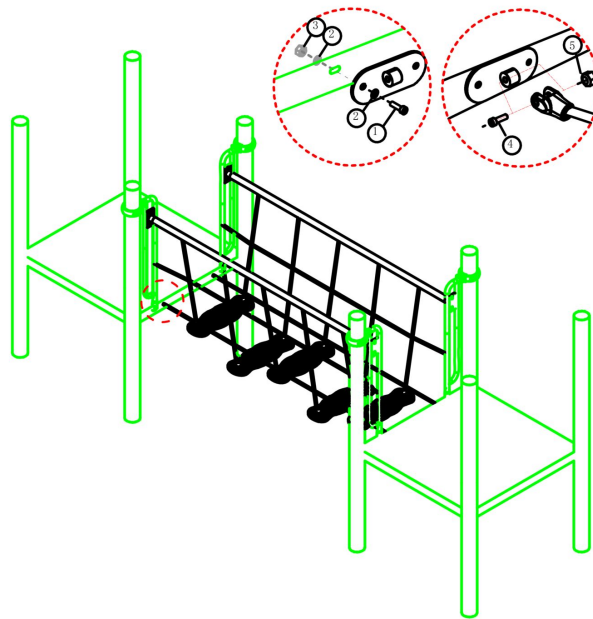







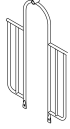

Bevestigings materiaal is per zakje verpakt en bovenstaande afbeelding zit in het zakje

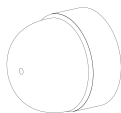
Hekje tbv glijstang

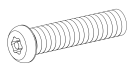
STAP 1 van 1

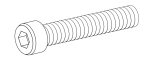
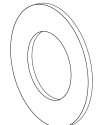
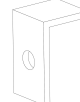
Omschrijving: Bevestiging van het hek tussen de vloer/staander

1 st. Hekje tbv glijstang	2 st. Small clamp + ring	2 st. Afdekdop M10	2 st. Kruiskop M6X65
			
4 st. Torx M8X20	4 st. Lock Moer M8	2 st. Lock Moer M6	2 st. Bout M10X25
			
4 st. Ring M10 (middel)	2 st. Hoekje	2 st. Lock Moer M10	
			

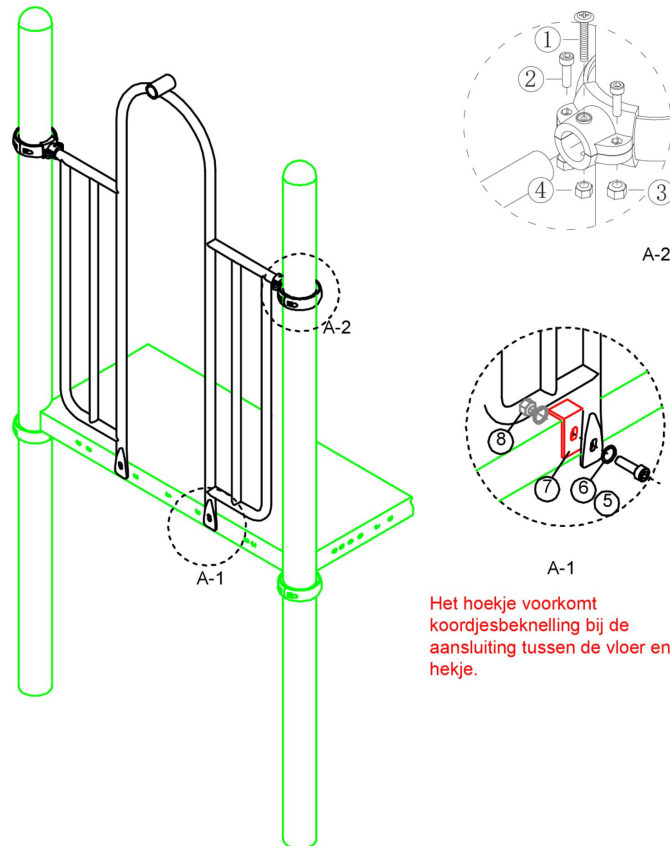

Het hoekje voorkomt koordjesbeknelling bij de aansluiting tussen de vloer en het hekje.

Bevestigings materiaal is per zakje verpakt en bovenstaande afbeelding zit in het zakje

150cm Glijstang

Hoofdafmetingen: 362x42cm

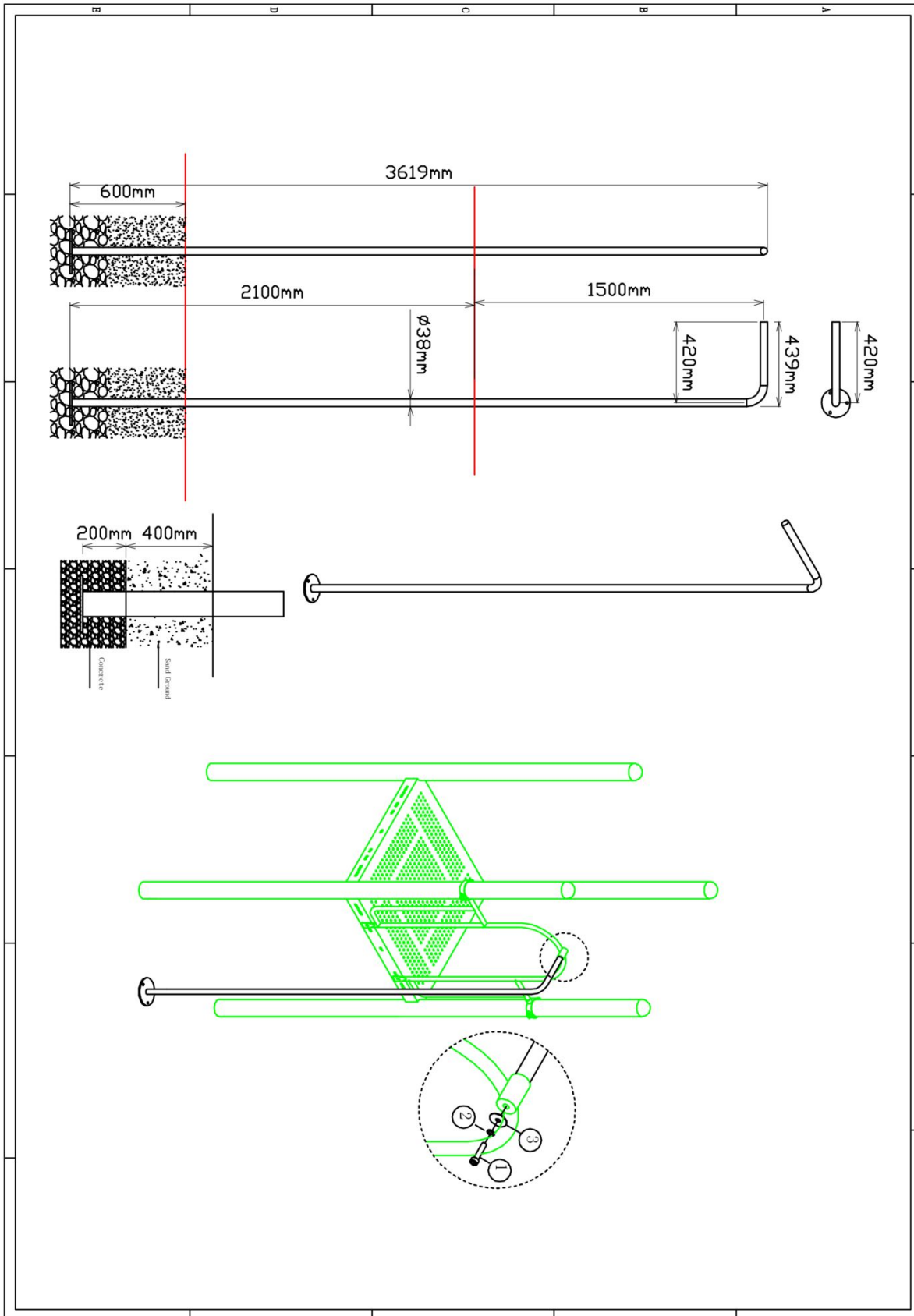

150cm Glijstang

STAP 1 van 1

Omschrijving: Bevestiging tussen de glijstang en het hek

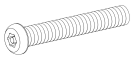
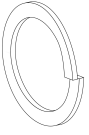
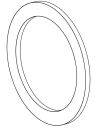
1 st. 150cm Glijstang	1 st. Torx M10X30	1 st. Veerring M10	1 st. Ring M10 (groot)
			

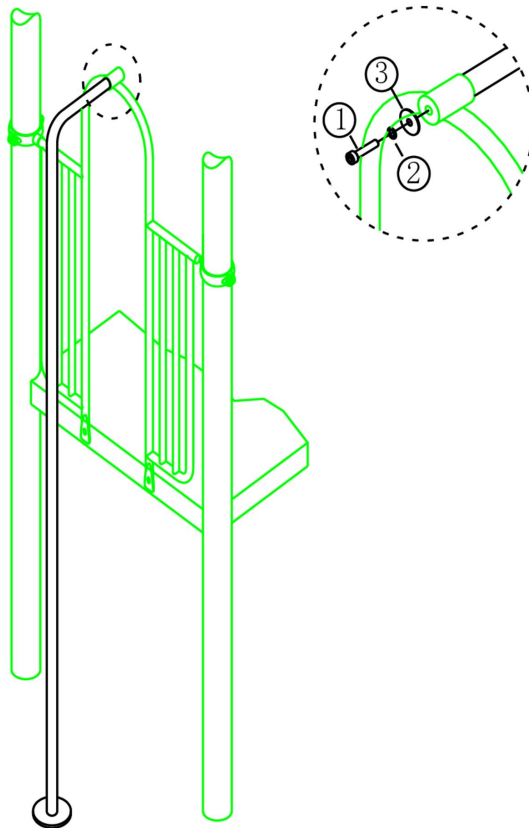





Bevestigings materiaal is per zakje verpakt en bovenstaande afbeelding zit in het zakje

Hekje tbv: B, Pod en Curly Climber

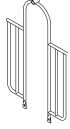
STAP 1 van 1

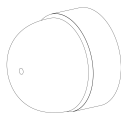
Omschrijving: Bevestiging van het hek tussen de vloer/staander

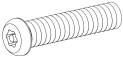
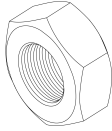
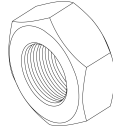
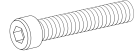
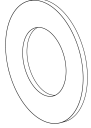
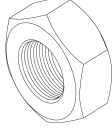
1 st. Hekje tbv: B, Pod en Curly Climber	2 st. Small clamp + ring	2 st. Afdekdop M10	2 st. Kruiskop M6X65
			
4 st. Torx M8X20	4 st. Lock Moer M8	2 st. Lock Moer M6	2 st. Bout M10X25
			
4 st. Ring M10 (middel)	2 st. Lock Moer M10		
			

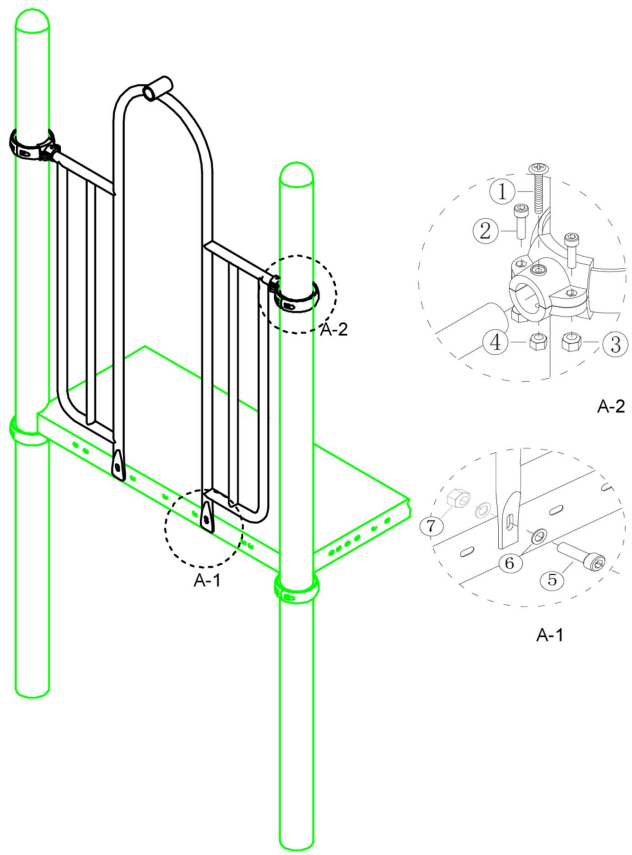

Bevestigings materiaal is per zakje verpakt en bovenstaande afbeelding zit in het zakje
150cm B climber

Hoofdafmetingen: 362x44cm

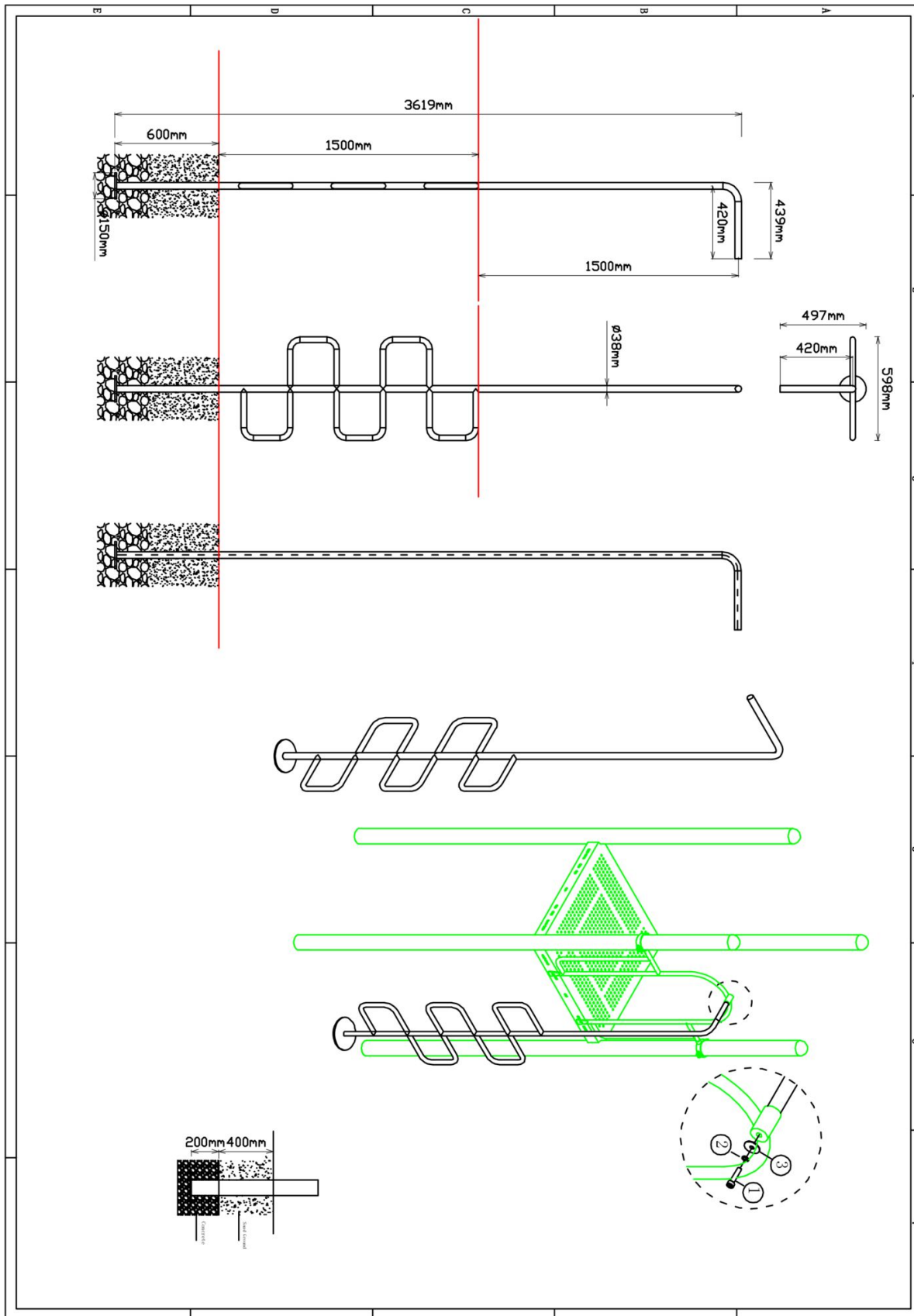

150cm B climber

STAP 1 van 1

Omschrijving: Bevestiging tussen B-climber en hek

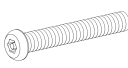
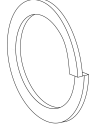
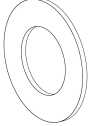
1 st. 150cm B climber	1 st. Torx M10X30	1 st. Veerring M10	1 st. Ring M10 (middel)
			

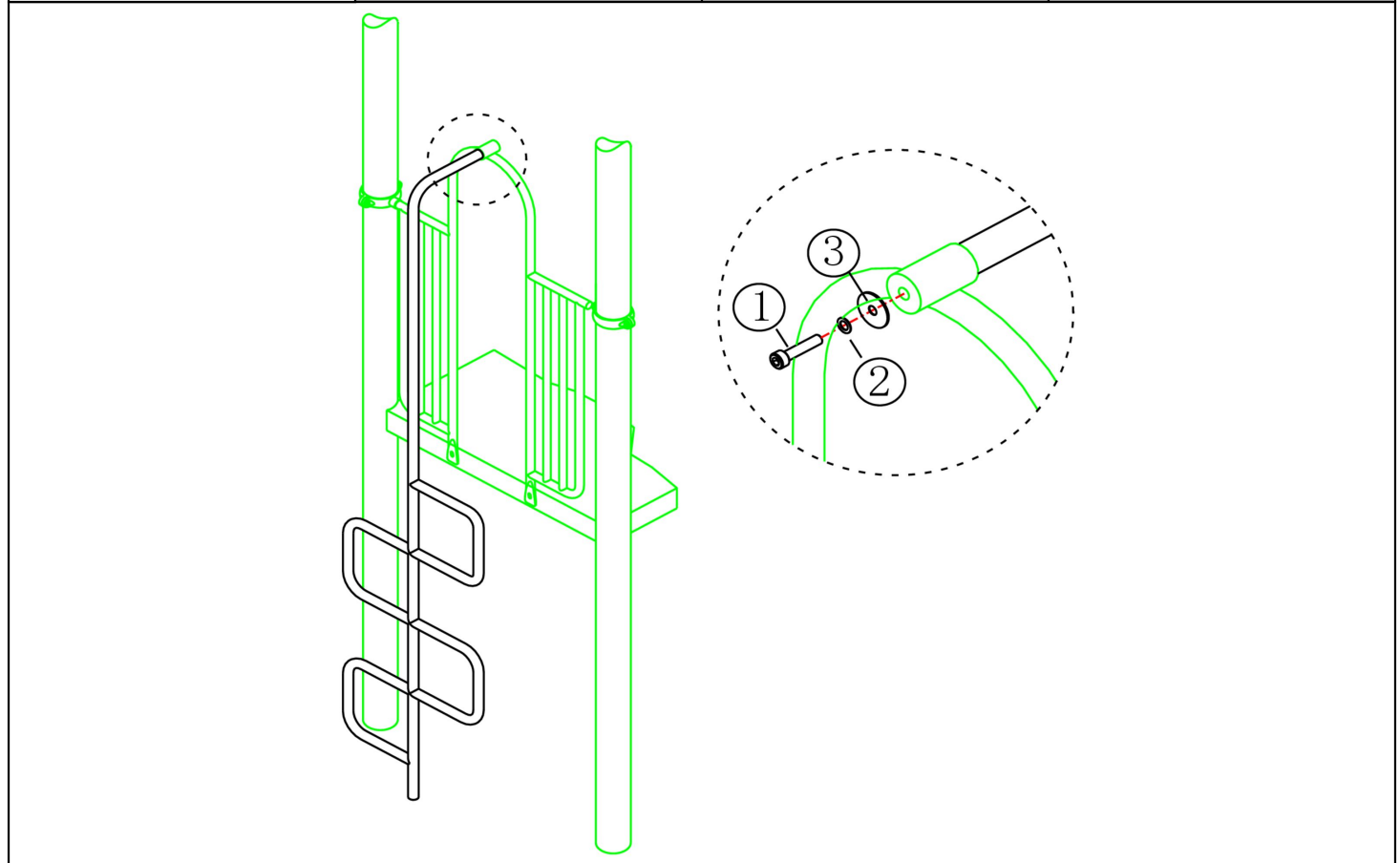

Bevestigings materiaal is per zakje verpakt en bovenstaande afbeelding zit in het zakje

Hekje zonder bevestiging (boven)



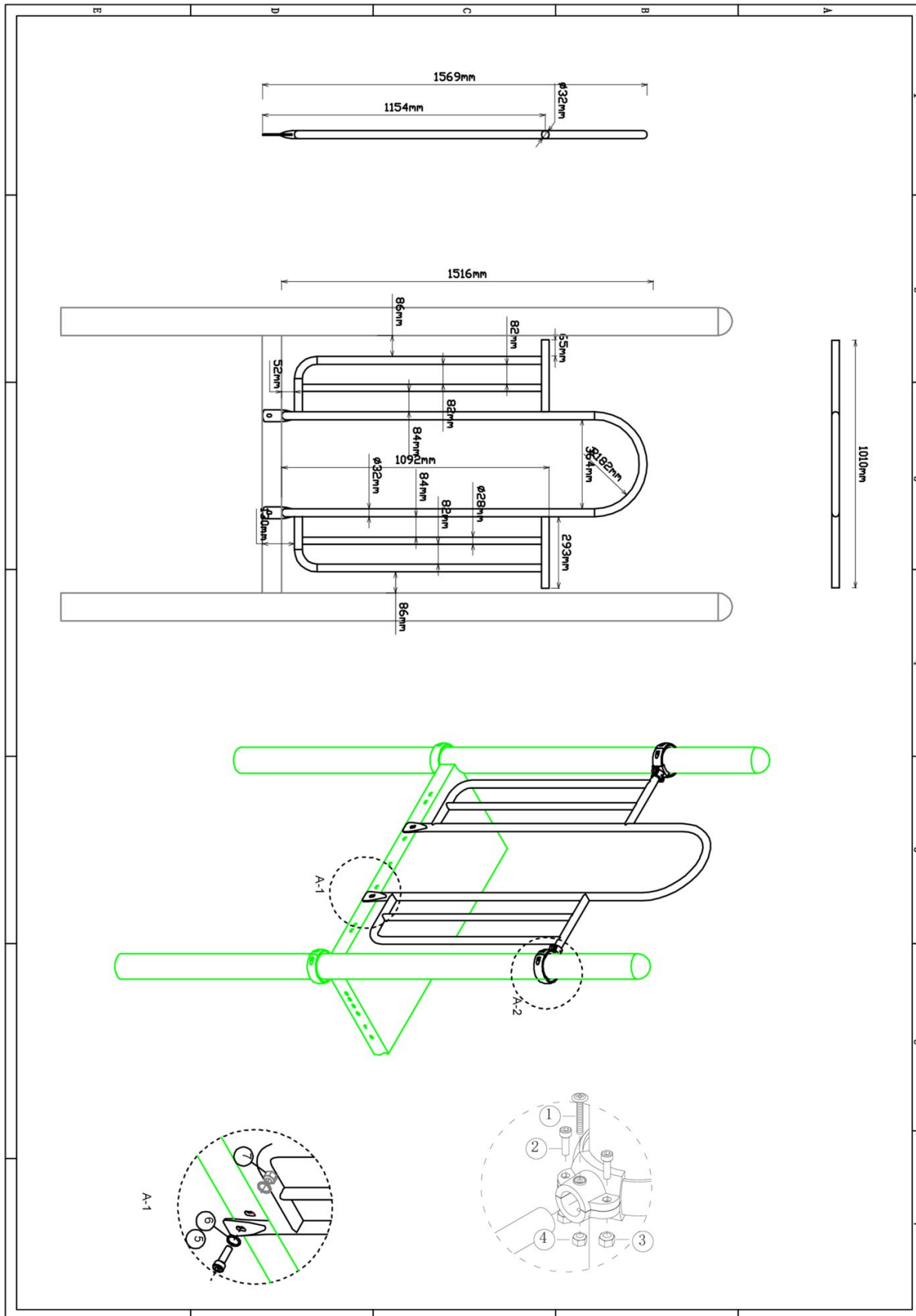

Hoofdafmetingen: 152x101cm

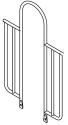

Hekje zonder bevestiging (boven)

STAP 1 van 1

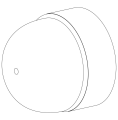
Omschrijving: Bevestiging van het hek tussen de vloer/staander

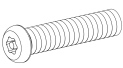
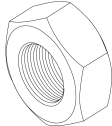
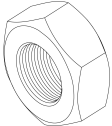
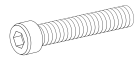
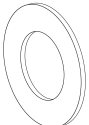
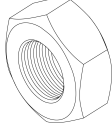
1 st. Hekje zonder bevestiging (boven)	2 st. Small clamp + ring	2 st. Afdekdop M10	2 st. Kruiskop M6X65
			
4 st. Torx M8X20	4 st. Lock Moer M8	2 st. Lock Moer M6	2 st. Bout M10X25
			
4 st. Ring M10 (middel)	2 st. Lock Moer M10		
			

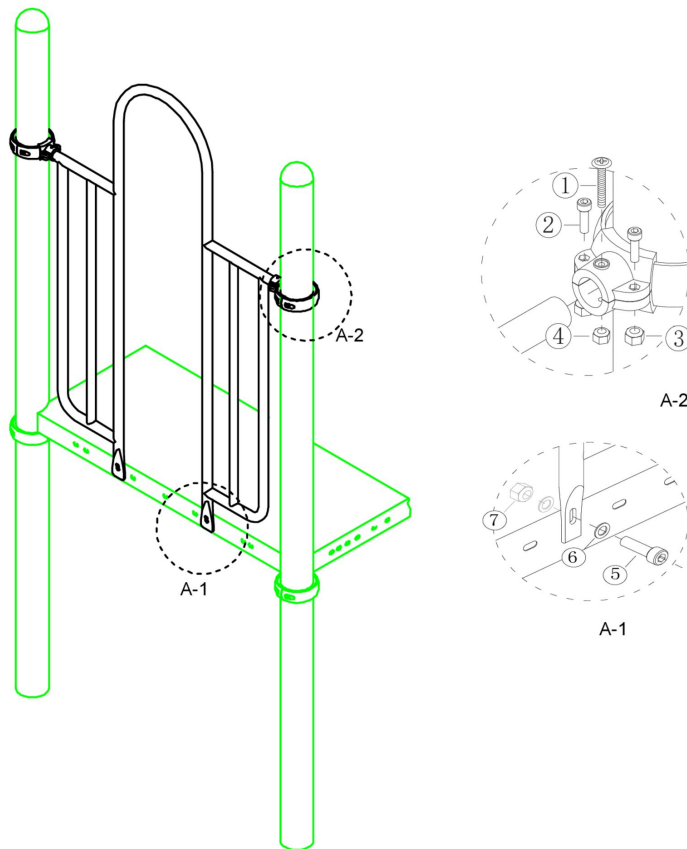

Bevestigings materiaal is per zakje verpakt en bovenstaande afbeelding zit in het zakje

150cm Arch climber

Hoofdafmetingen: 217x150x73cm

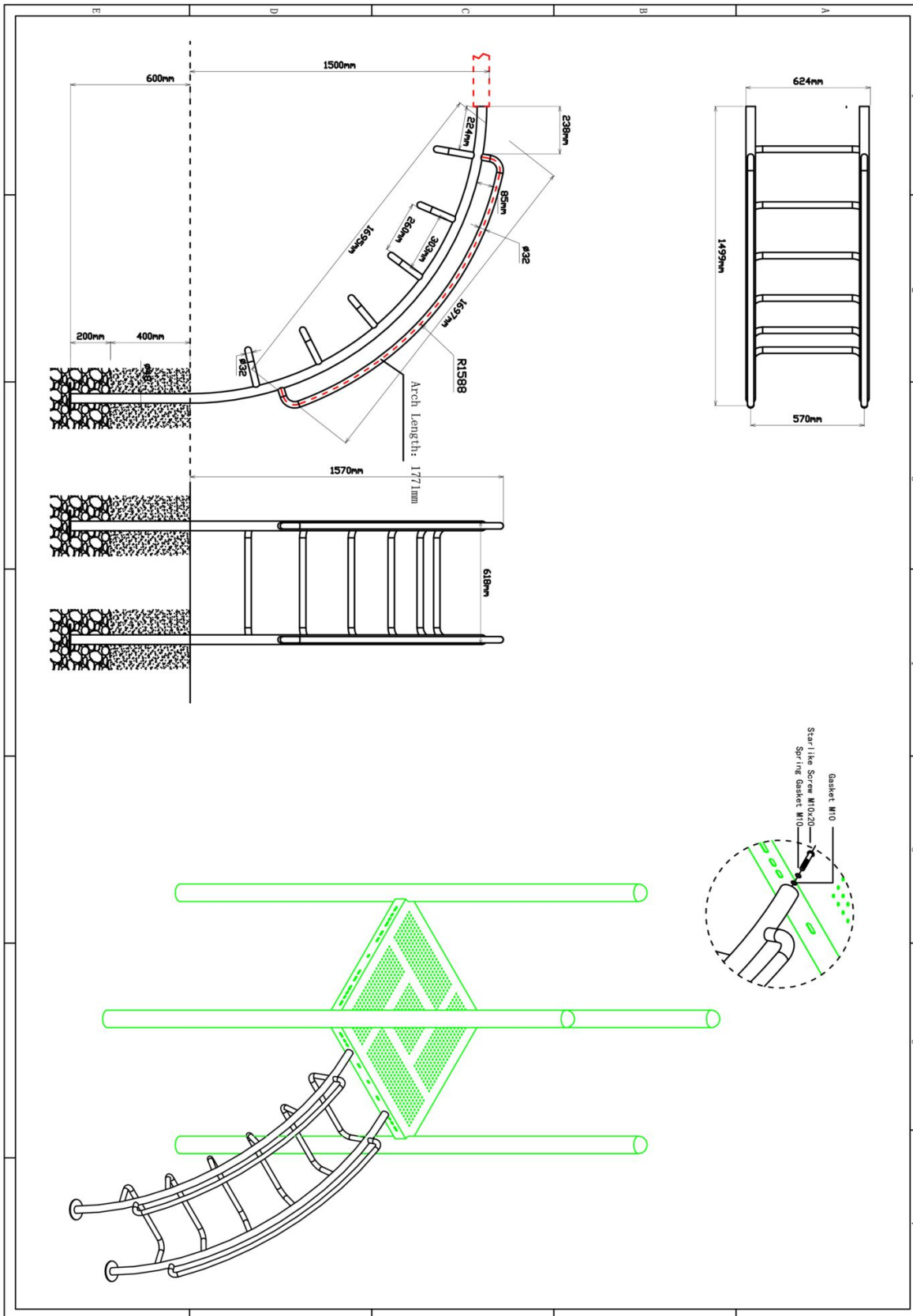

150cm Arch climber

STAP 1 van 1

Omschrijving: Bevestiging tussen vloer en Arch climber

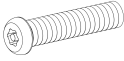
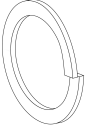
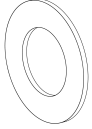
1 st. 150cm Arch climber	2 st. Torx M10X20	2 st. Veerring M10	2 st. Ring M10 (middel)
	<p>1</p> 	<p>2</p> 	<p>3</p> 

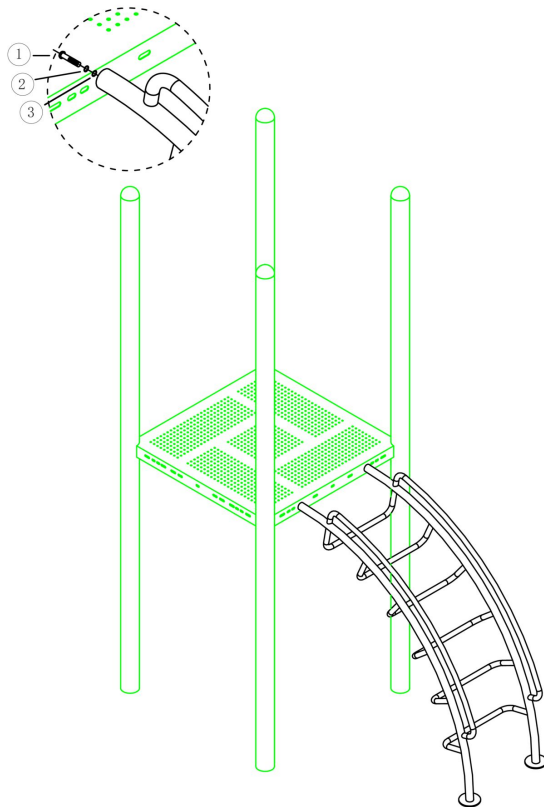

Bevestigings materiaal is per zakje verpakt en bovenstaande afbeelding zit in het zakje

Hek voor RVS glijbaan



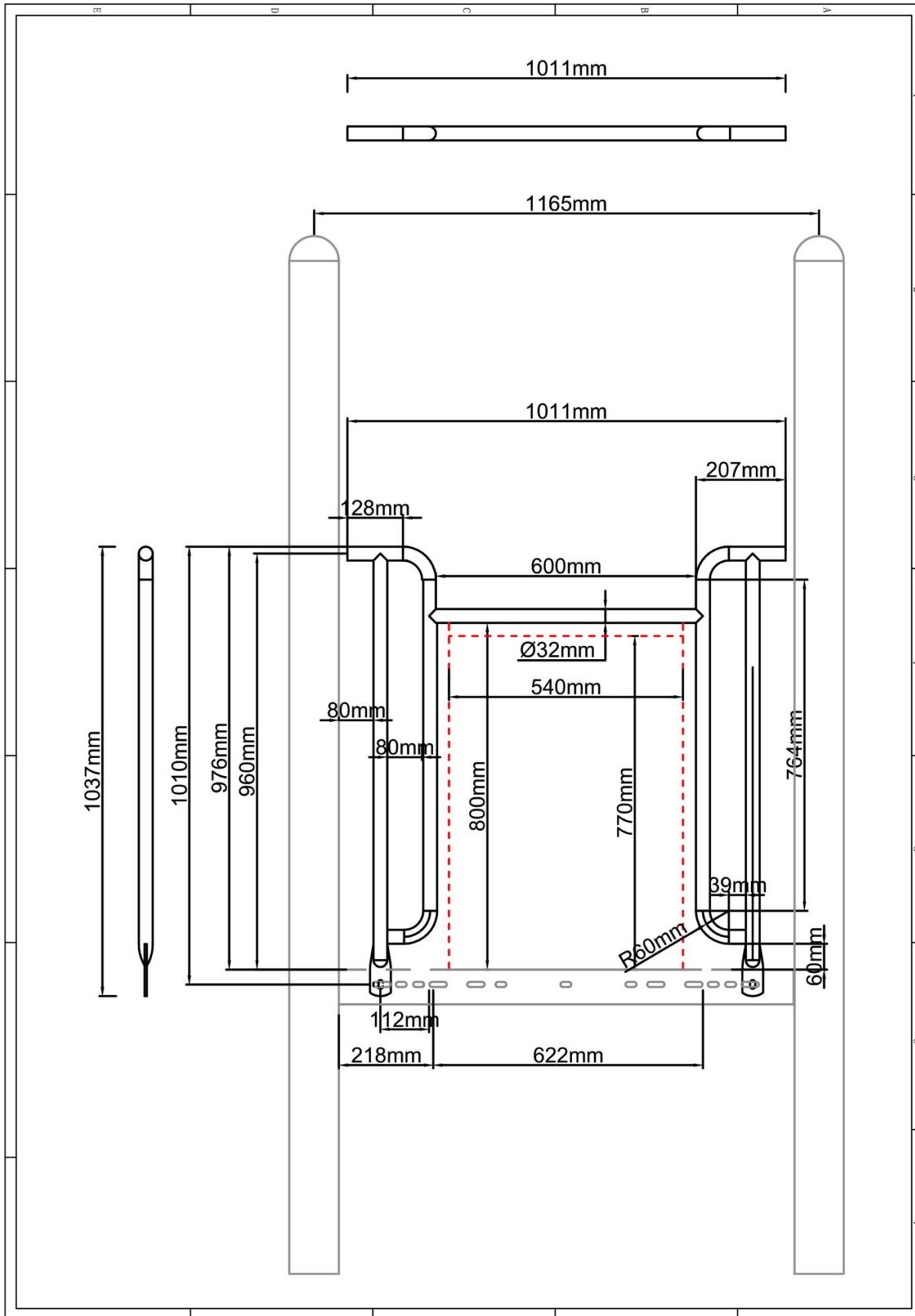

Hoofdafmetingen: 104x101cm

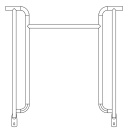

Hek voor RVS glijbaan

STAP 1 van 1

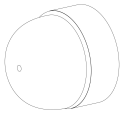
Omschrijving: Bevestiging tussen de vloer/staander en het hekje

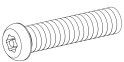
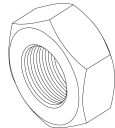
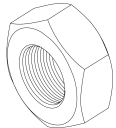
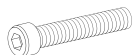
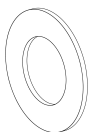
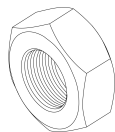
1 st. Hek voor RVS glijbaan	2 st. Small clamp + ring	2 st. Afdekdop M10	2 st. Kruiskop M6X65
			① 
4 st. Torx M8X20	4 st. Lock Moer M8	4 st. Lock Moer M6	2 st. Bout M10X25
② 	③ 	④ 	⑤ 
4 st. Ring M10 (middel)	2 st. Lock Moer M10		
⑥ 	⑦ 		

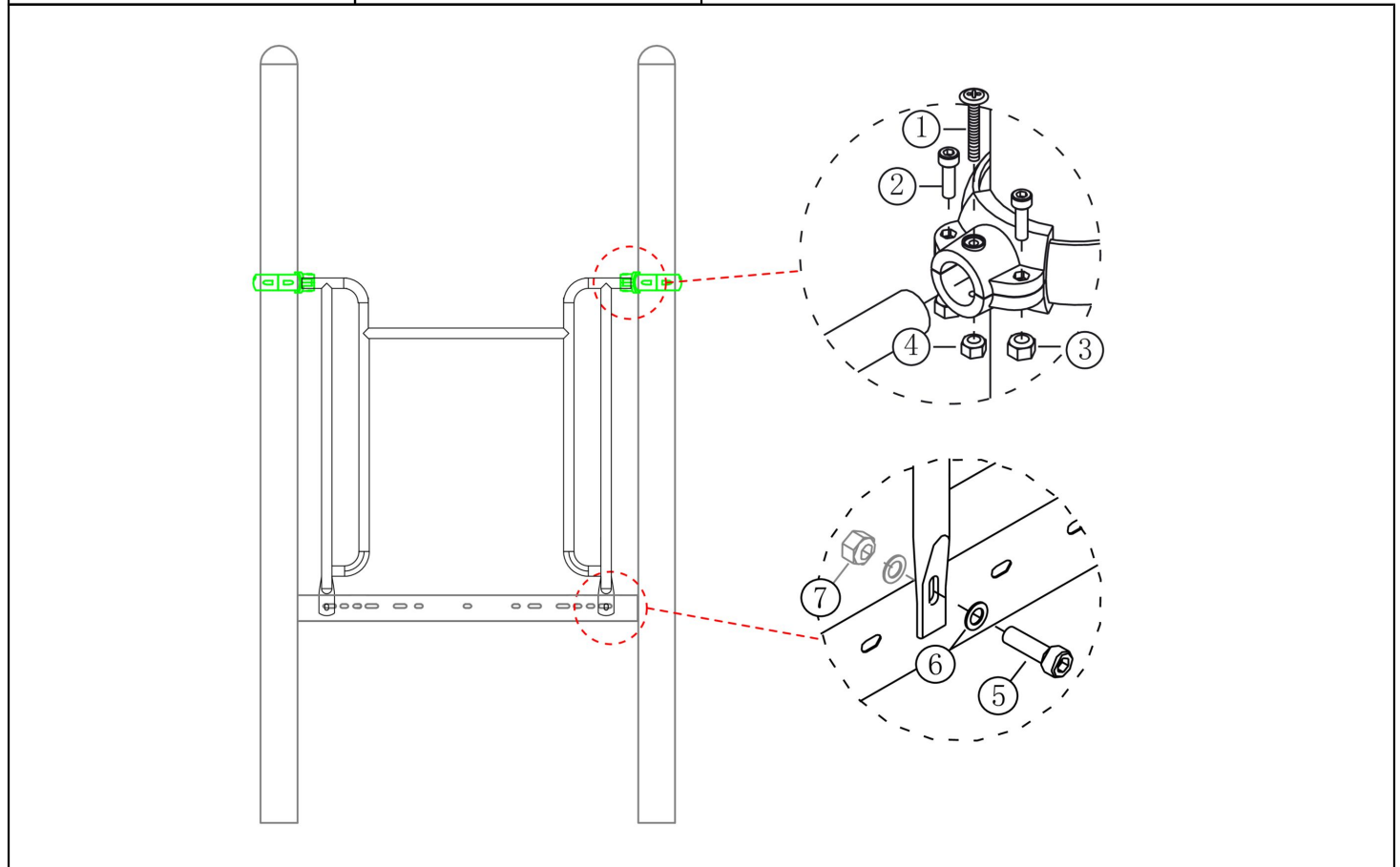

Bevestigings materiaal is per zakje verpakt en bovenstaande afbeelding zit in het zakje

RVS Glijbaan 150cm

Hoofdafmetingen: 250x297x54cm

alle afmetingen zijn in mm.

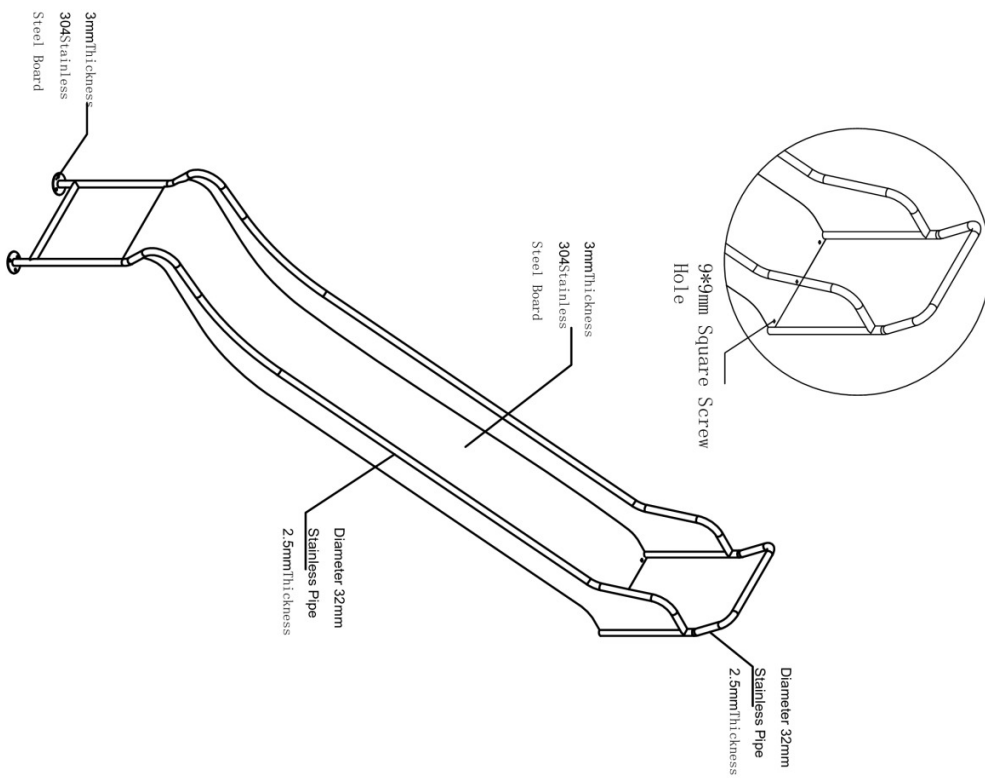
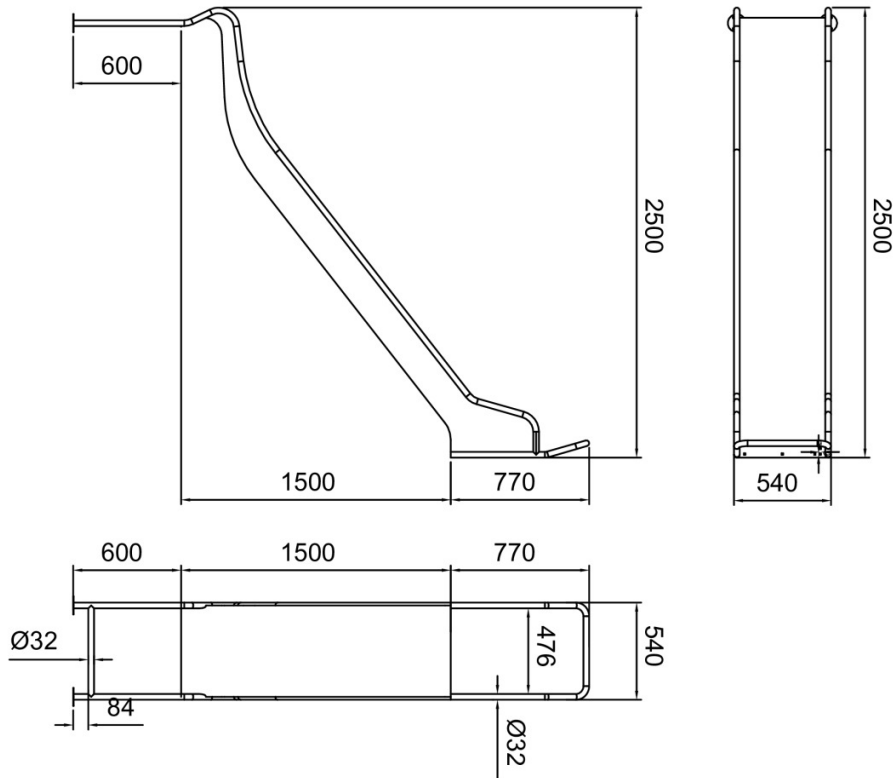



1500mm Slide

RVS Glijbaan 150cm

STAP 1 van 2

Omschrijving: Bevestigings gaten in de vloer boren volgens schema

1 st. Boormachine	1 st. Boortje 8,5mm
	

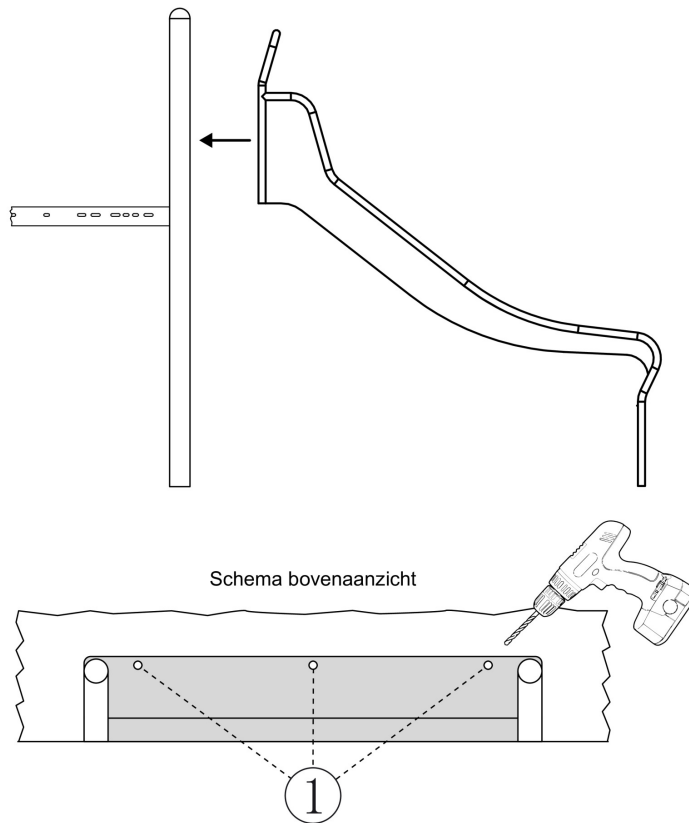

Bevestigings materiaal is per zakje verpakt en bovenstaande afbeelding zit in het zakje

RVS Glijbaan 150cm

STAP 2 van 2

Omschrijving: Glijbaan op de vloer bevestigen met bijgeleverde montagepakket.

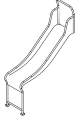
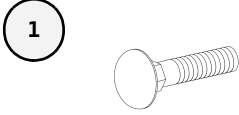
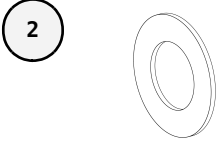
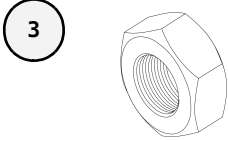
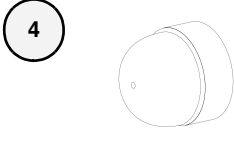
1 st. RVS Glijbaan 90cm	2 st. Slotbout M8X20	
		
2 st. Ring M8 (middel)	2 st. Lock Moer M8	2 st. Afdekdop M8
		

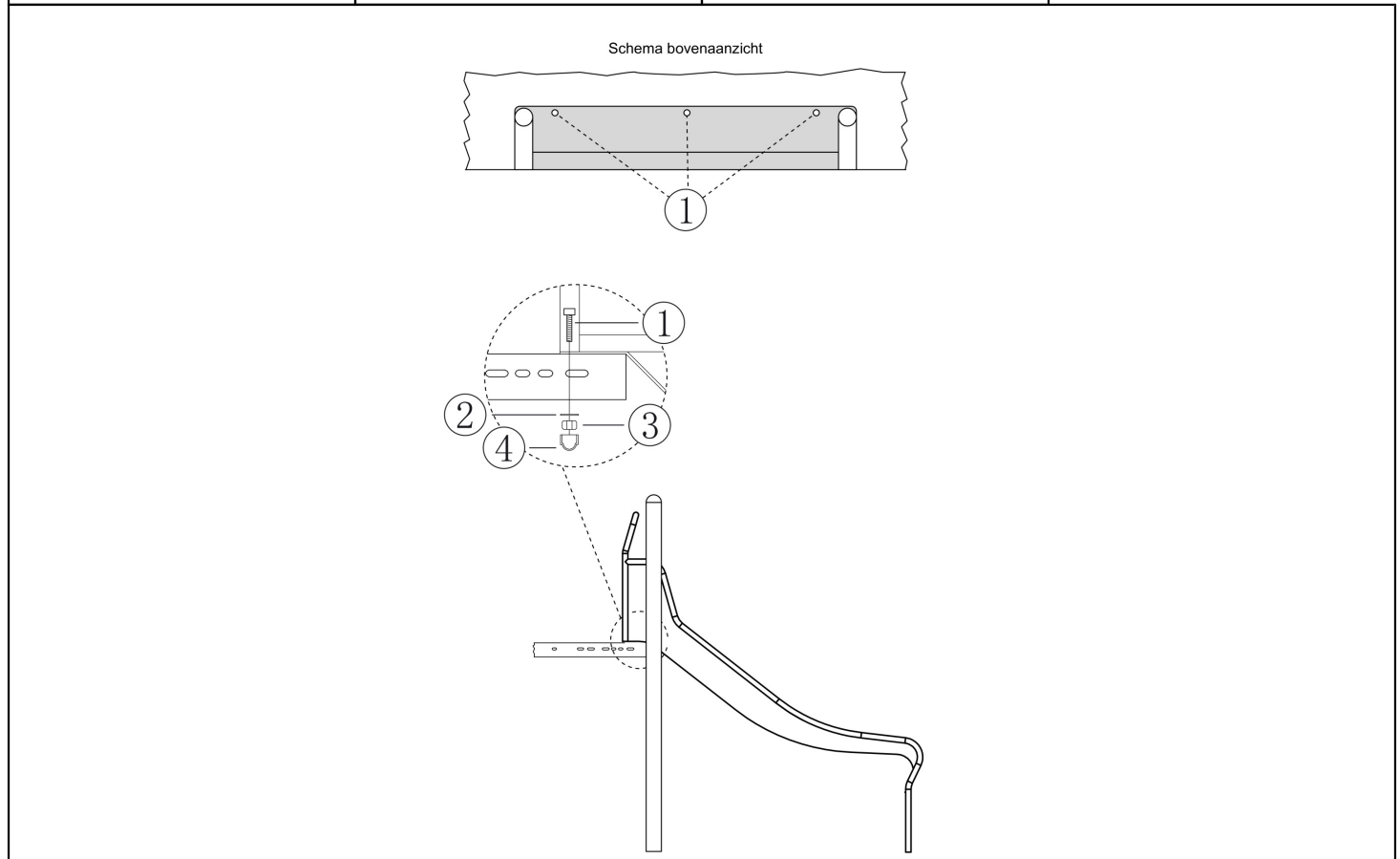

Bevestigings materiaal is per zakje verpakt en bovenstaande afbeelding zit in het zakje