



TnT speeltoestellen

Montagehandleiding

3do-529



Toestel	3do-529
Datum montagehandleiding	21-05-2026

Beste klant van TnT Speeltoestellen,

Wij danken u voor het aanschaffen en installeren van een speeltoestel van TnT Speeltoestellen. Wij waarderen het vertrouwen dat u in ons bedrijf heeft geplaatst en streven ernaar om uw vertrouwen meer dan waar te maken!

Dit is uw TnT speeltoestellen montagehandleiding.

Wij hebben deze handleiding specifiek voor het product ontworpen, waarop eveneens de toe te passen onderdelen zijn genoemd.

Ook vindt u het grondplan met de benodigde valruimte volgens norm NEN-EN1176-1 : 2017.

Bewaart u dit document bij uw logboek. Nogmaals willen wij u bedanken voor de aankoop van dit speeltoestel. Wij zien uit naar uw volgende speelproject.

Met vriendelijke groet, TnT Speeltoestellen

Inhoudsopgave

Aanzichten 3D	2
Onderdelenlijst	4
Veiligheidsruimtes	5
Zijaanzichten	6
Plattegrond palenplan	8
Paalmaten	9
Paaldata	10
Onderdeel handleidingen	11
Staander 350cm	12
Halve zeskant vloer (vloer_zeshoek_half)	14
Standaard trap (opgang_trap)	16
Glijstang (glijstang_150cm)	20
Slangen opgang (klimrek_slang_150cm)	24
Opgang doppen (opgang_doppen_150cm)	28
Glijbaan RVS (glijbaan_150cm_metaal)	32
Bankje (bankje)	37

Aanzichten 3D



Aanzicht 1



Aanzicht 2

Aanzichten 3D







Aanzicht 3

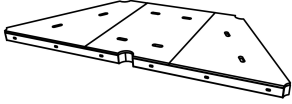
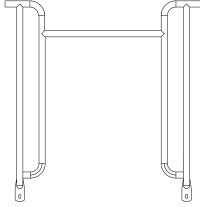
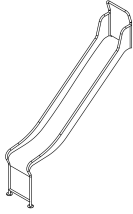
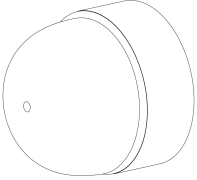
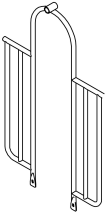

Aanzicht 4

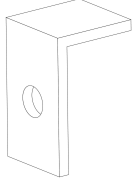
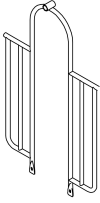
Onderdelenlijst

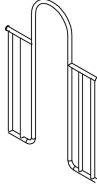
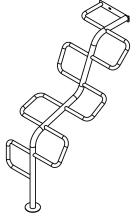
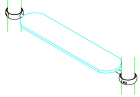
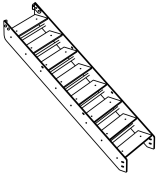
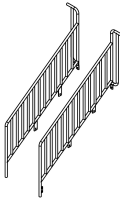
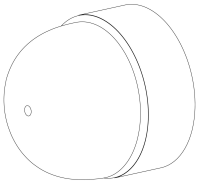
<p>5x Staander 350cm 350x11,5cm</p> 	<p>1x Halve zeskant vloer HPL (5 staanders) 227x101x8,5cm</p> 	<p>1x Hek voor RVS glijbaan 104x101cm</p> 	<p>1x RVS Glijbaan 150cm 250x297x54cm</p> 
<p>10x Afdekdop M8 M8</p> 	<p>1x Hekje tbv glijstang 152x101cm</p> 	<p>1x 150cm Glijstang 362x42cm</p> 	<p>2x Hoekje</p> 
<p>1x Hekje tbv: B, Pod en Curly Climber 152x101cm</p> 	<p>1x 150cm Pod climber 362x71cm</p> 	<p>1x Hekje tbv Snake climber 138x101cm</p> 	<p>1x 150cm Snake climber 209x67cm</p> 
<p>1x Bankje 2.0 116x22x4cm</p> 	<p>1x 150cm trap HPL 175x64x19cm</p> 	<p>1x 150cm trapleuningen HPL (2 stuks) 278x144x18cm</p> 	<p>20x Afdekdop M10 M10</p> 

Veiligheidsruimtes

Geachte klant,

Zorg er altijd voor dat alle veiligheidsruimtes zoals aangegeven in ieder geval gehaald worden, dit zijn de minimale vereiste ruimtes voor een veilig gebruik van het speeltoestel.

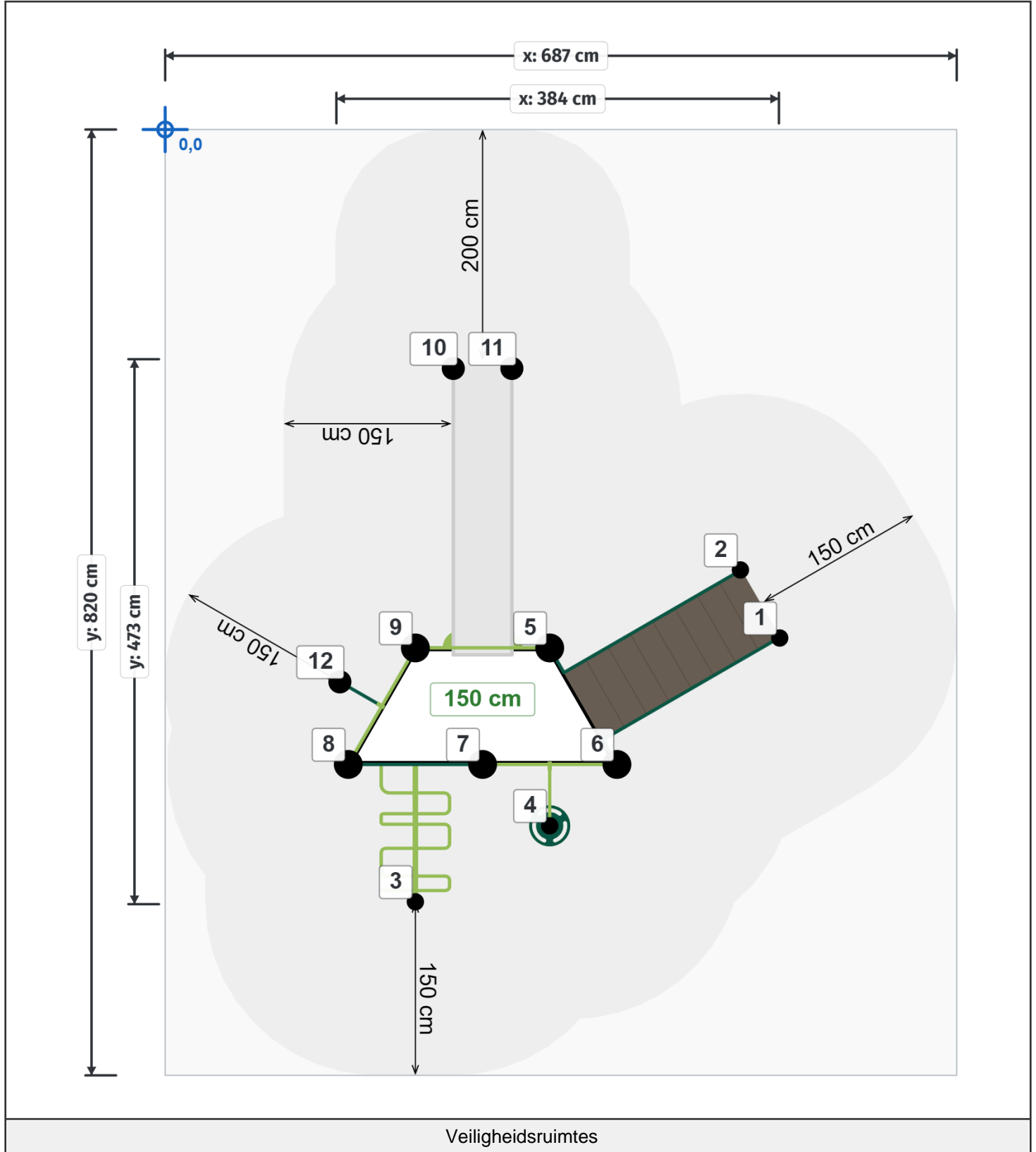

Zijaanzichten

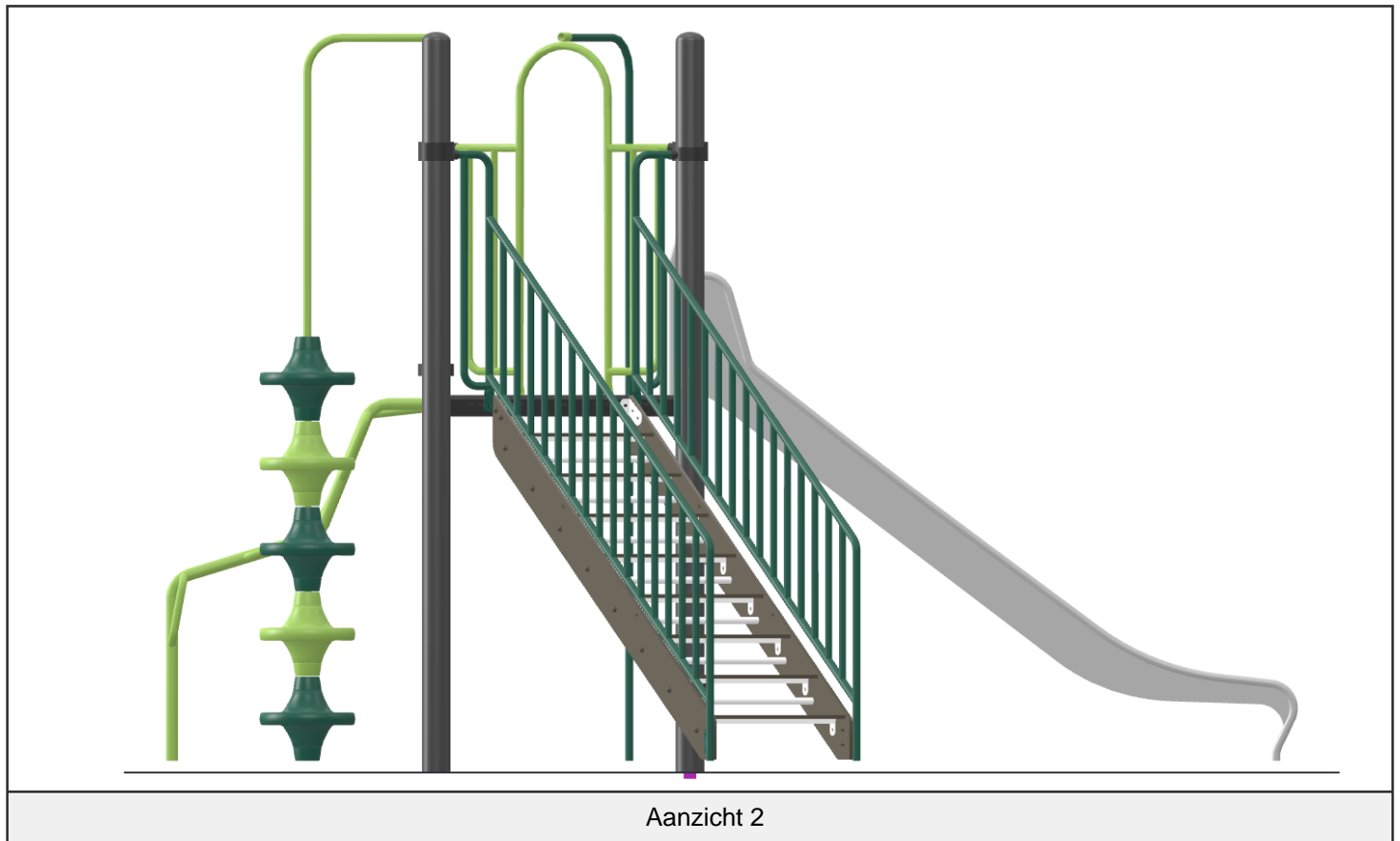
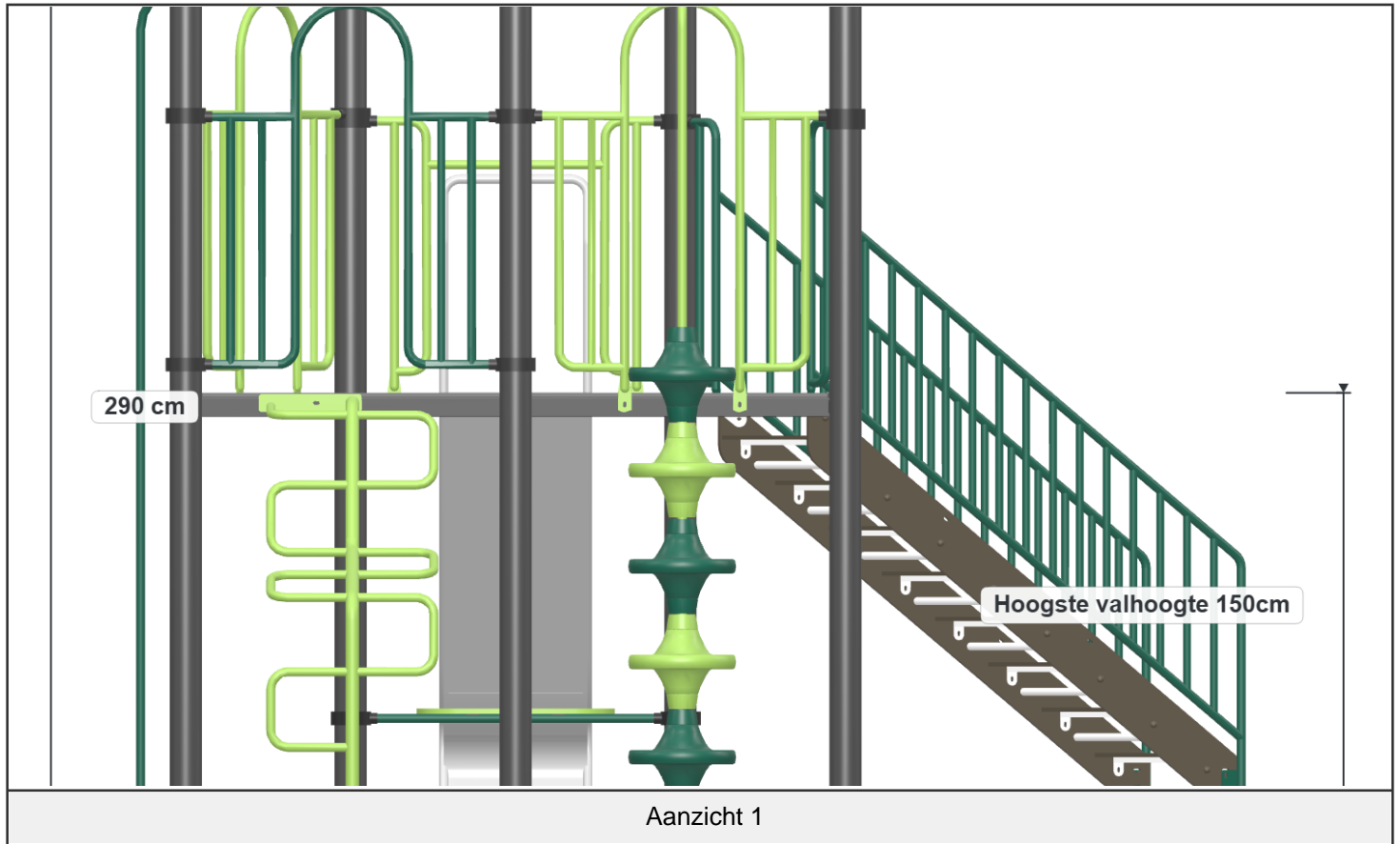

Zijaanzichten



Aanzicht 3



Aanzicht 4

Plattegrond palenplan

U kunt van deze tekening niet afmeten!

Voor de betonfundatie heeft u 37,5 kg snelbeton per staander nodig.

Voor de overige onderdelen (Glijstangen, Climbers, Glijbaan voeten) 25 kg snelbeton.

Houdt u er rekening mee dat de betonfundatie minimaal 400mm onder het maaiveld blijft, zoals op de tekening afgebeeld.

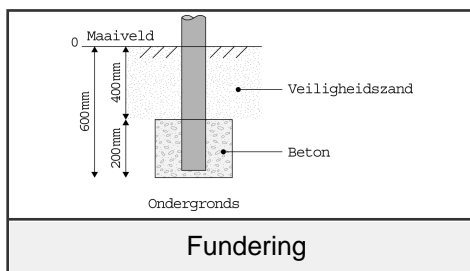
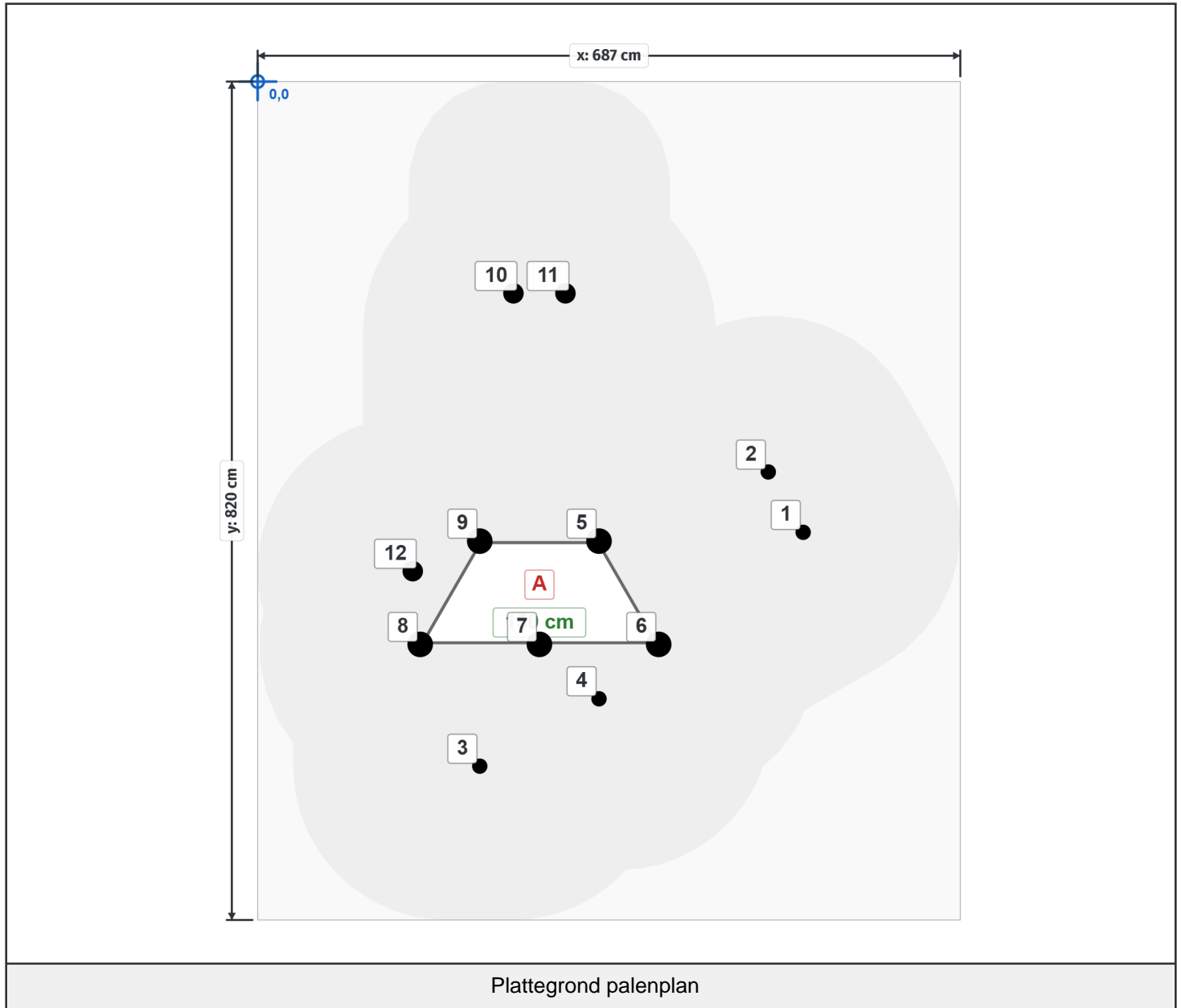

Paalmaten

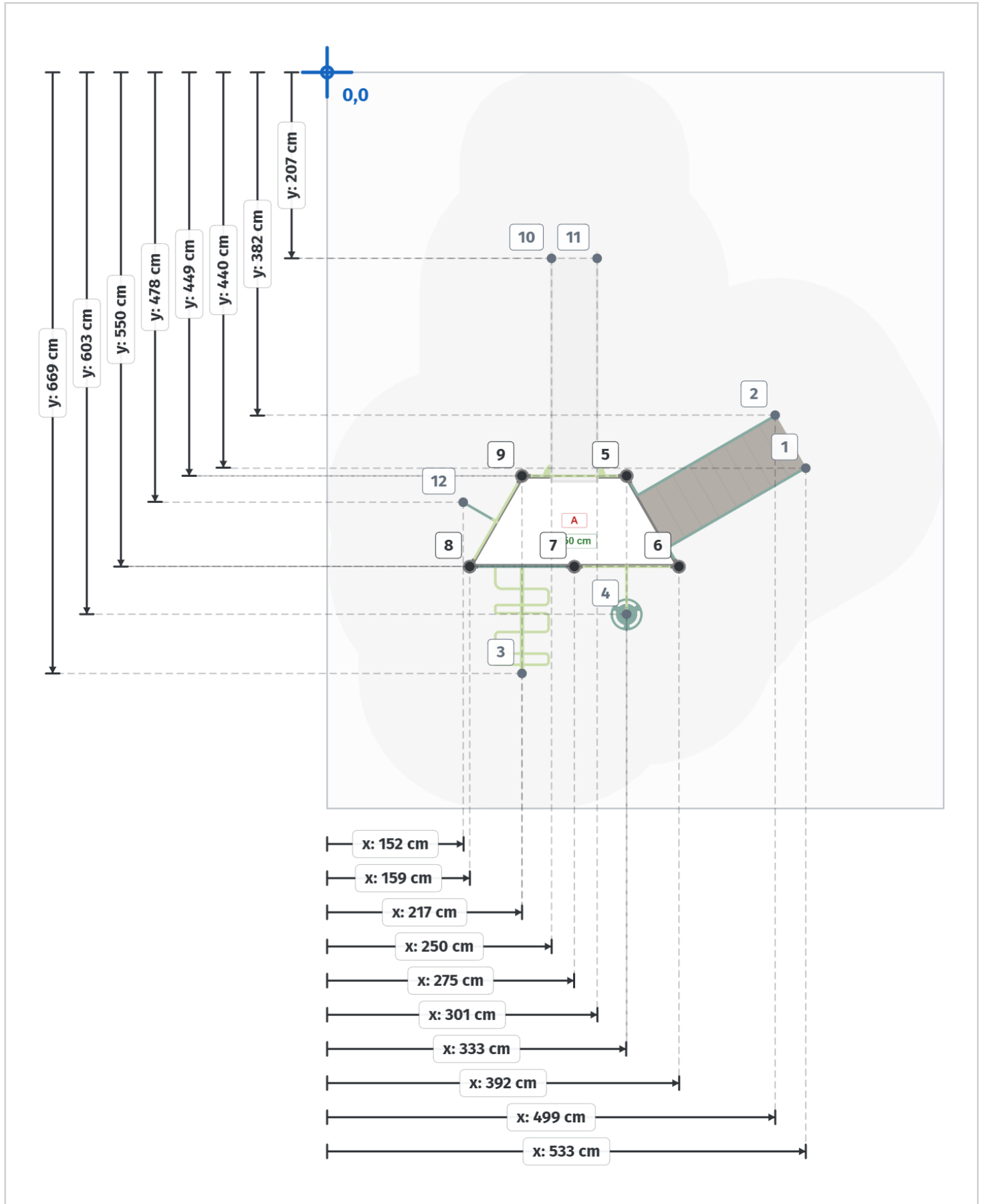

Paaldata

Staanders			
Label	X	Y	Hoogte
1	533 cm	441 cm	0 cm
2	499 cm	382 cm	0 cm
3	217 cm	669 cm	0 cm
4	334 cm	604 cm	0 cm
5	334 cm	450 cm	350 cm
6	392 cm	550 cm	350 cm
7	276 cm	550 cm	350 cm
8	159 cm	550 cm	350 cm
9	217 cm	450 cm	350 cm
10	250 cm	208 cm	0 cm
11	301 cm	208 cm	0 cm
12	152 cm	479 cm	0 cm

Vloeren	
Label	Hoogte
A	150 cm

Onderdeel handleidingen

Op de volgende pagina's van dit document vindt u alle individuele onderdelen met bijbehorende technische tekeningen en eventuele montage instructies.

Staander 350cm

Hoofdafmetingen: 350x11,5cm

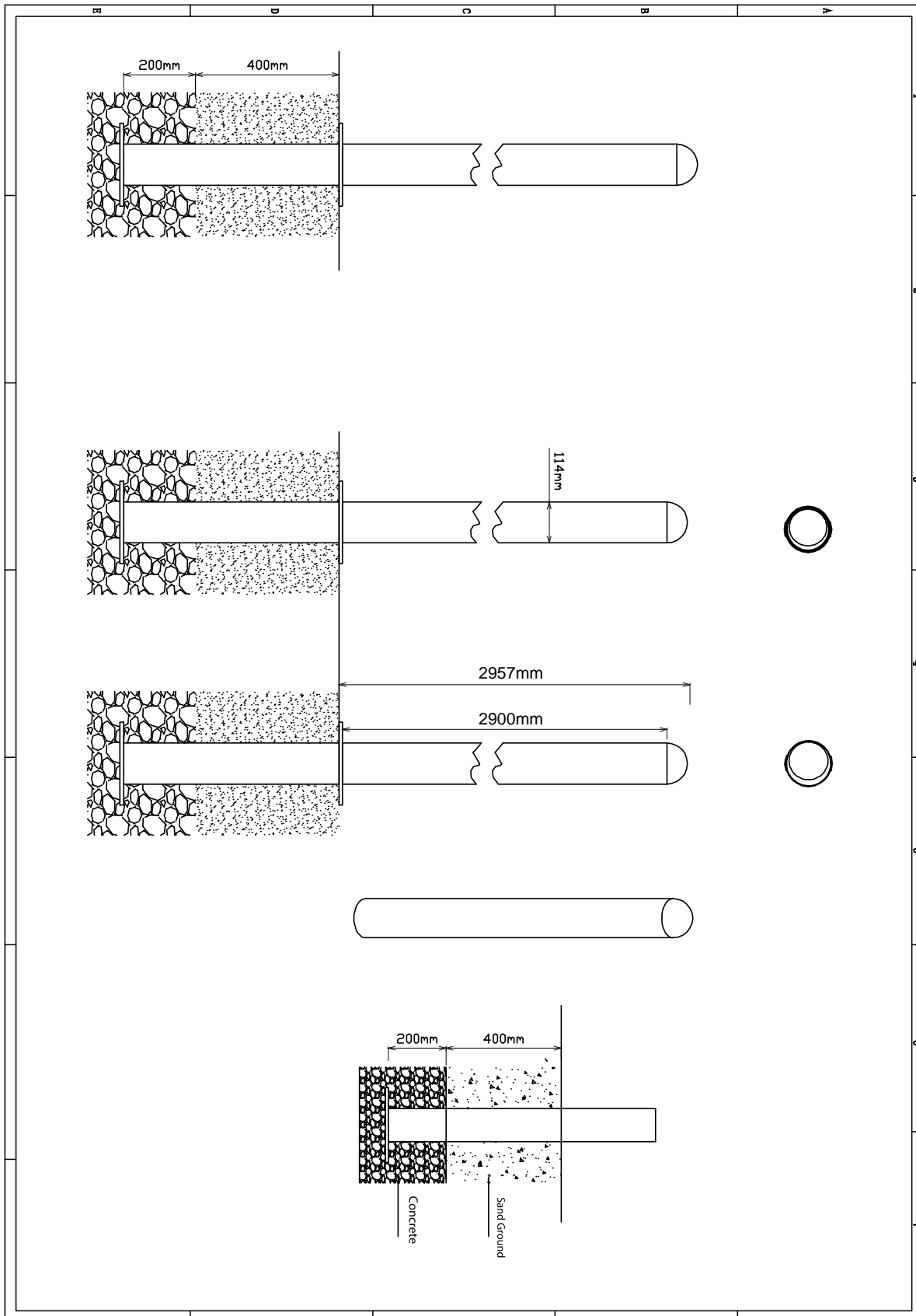

Staander

STAP 1 van 1

Omschrijving: Paalkap losdraaien en opnieuw bevestigen met loctite op het draadeind

1 st. Loctite

1

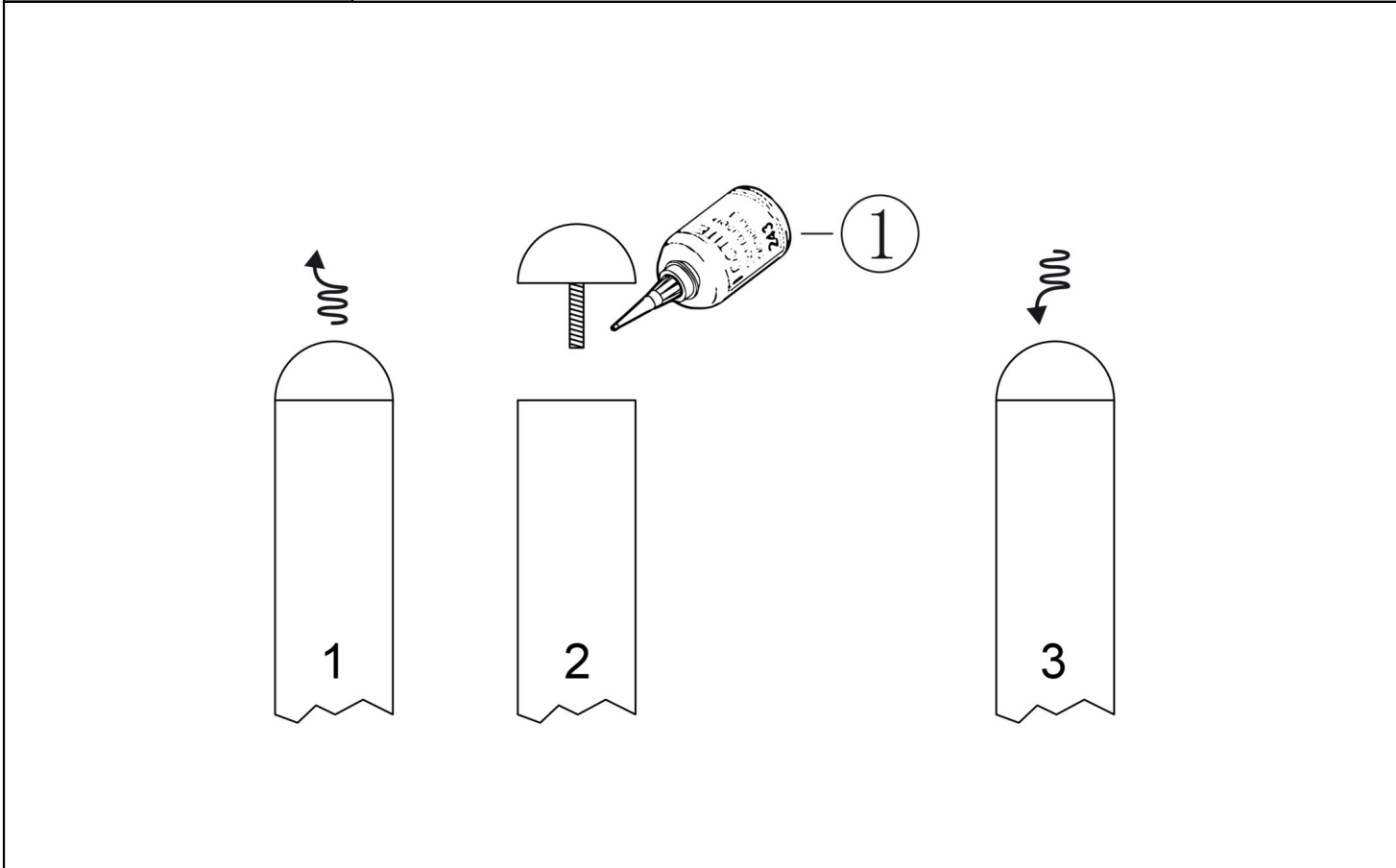

Bevestigings materiaal is per zakje verpakt en bovenstaande afbeelding zit in het zakje

Halve zeskant vloer HPL (5 staanders)

Hoofdafmetingen: 227x101x8,5cm

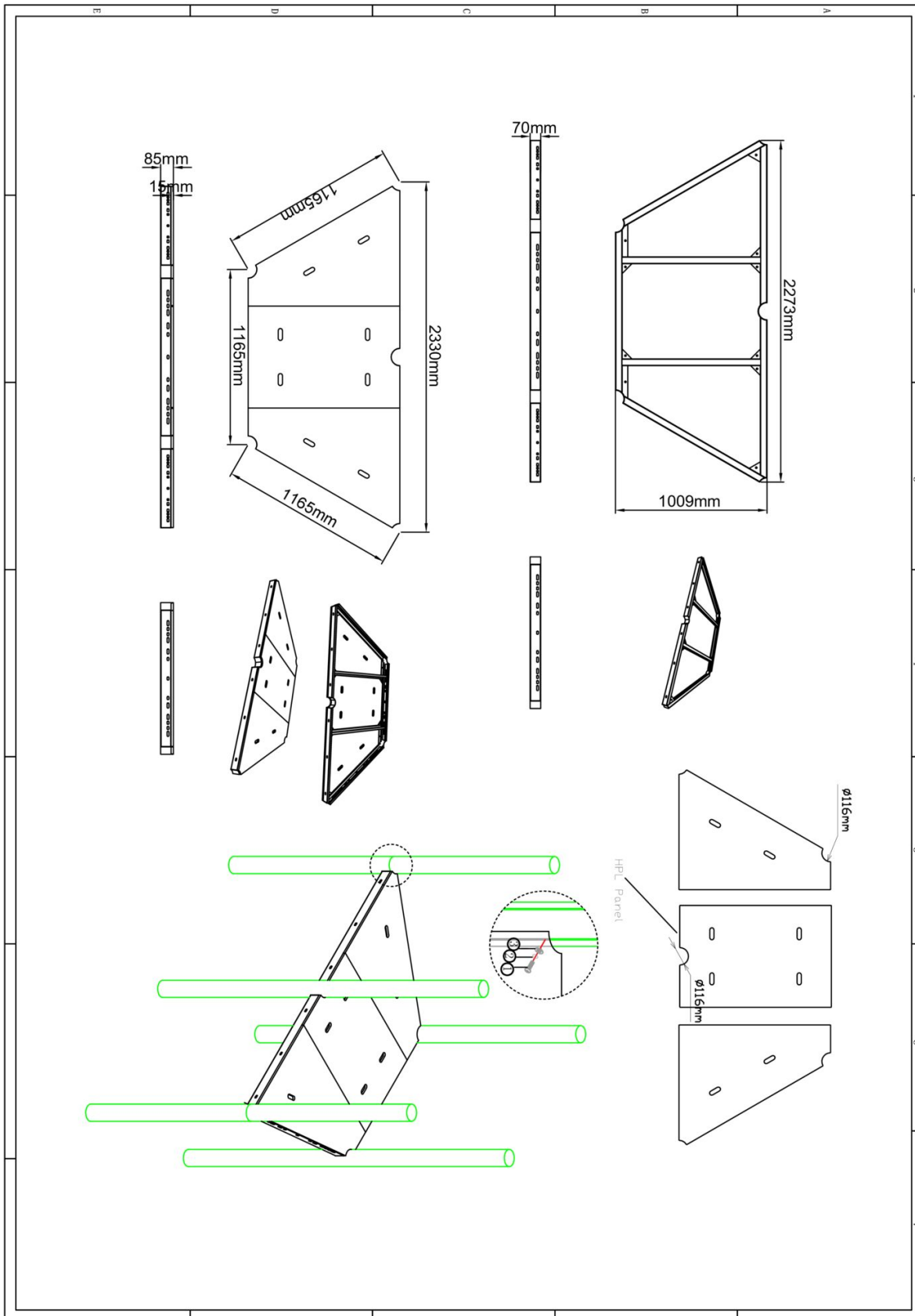

Halve zeskant vloer HPL (5 staanders)

STAP 1 van 1

Omschrijving: Bevestiging van de vloer aan de staander. In de staander zitten al voor gemonteerde M10 bussen op de juiste hoogte waar de bout ingedraaid dienen te worden.

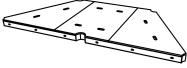
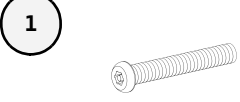
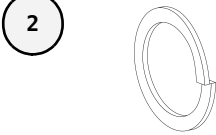
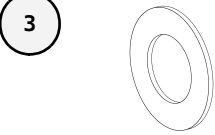
1 st. Halve zeskant vloer HPL (5 staanders)	5 st. Torx M10X30	5 st. Veerring M10	5 st. Ring M10 (middel)
			

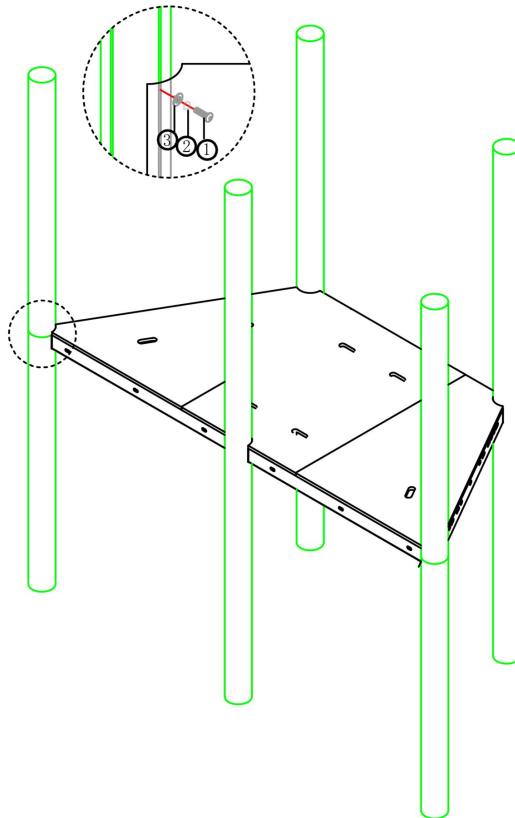

Bevestigings materiaal is per zakje verpakt en bovenstaande afbeelding zit in het zakje

150cm trap HPL

Hoofdafmetingen: 175x64x19cm

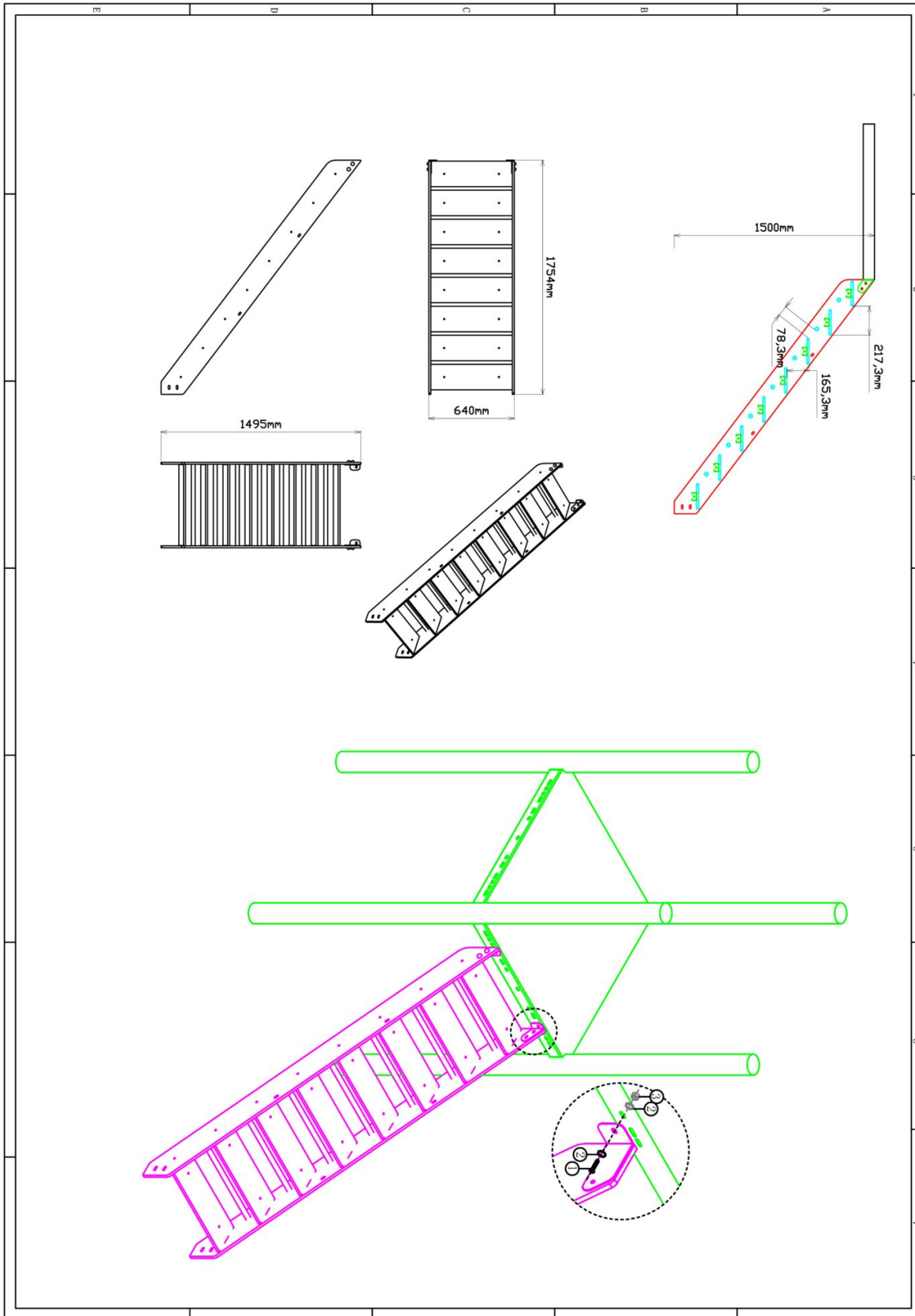

150cm trap HPL

STAP 1 van 1

Omschrijving: Bevestiging van de trap aan de vloer

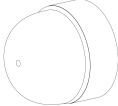
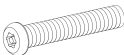
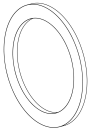
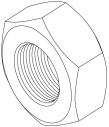
1 st. 150cm trap HPL	3 st. Afdekdop M10	3 st. Torx M10X25	6 st. Ring M10 (groot)
		1 	2 
3 st. Lock Moer M10			
3 			

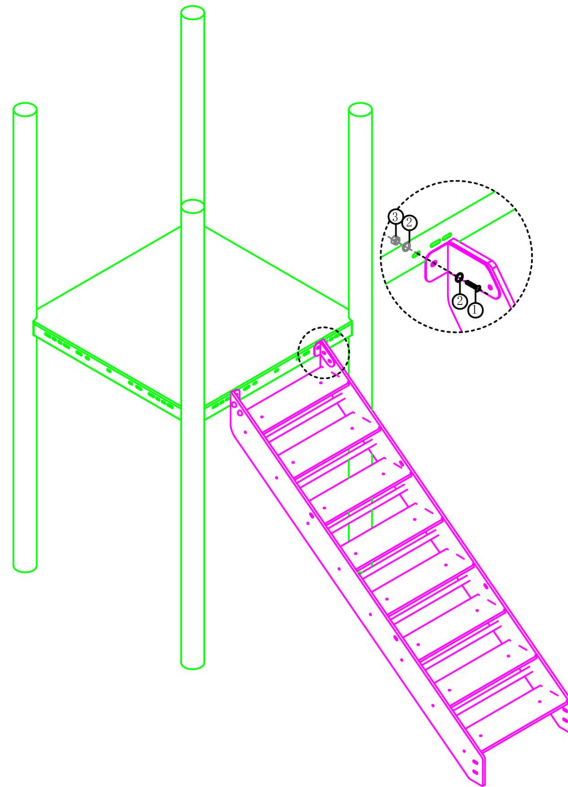

Bevestigings materiaal is per zakje verpakt en bovenstaande afbeelding zit in het zakje

150cm trapleuningen HPL (2 stuks)



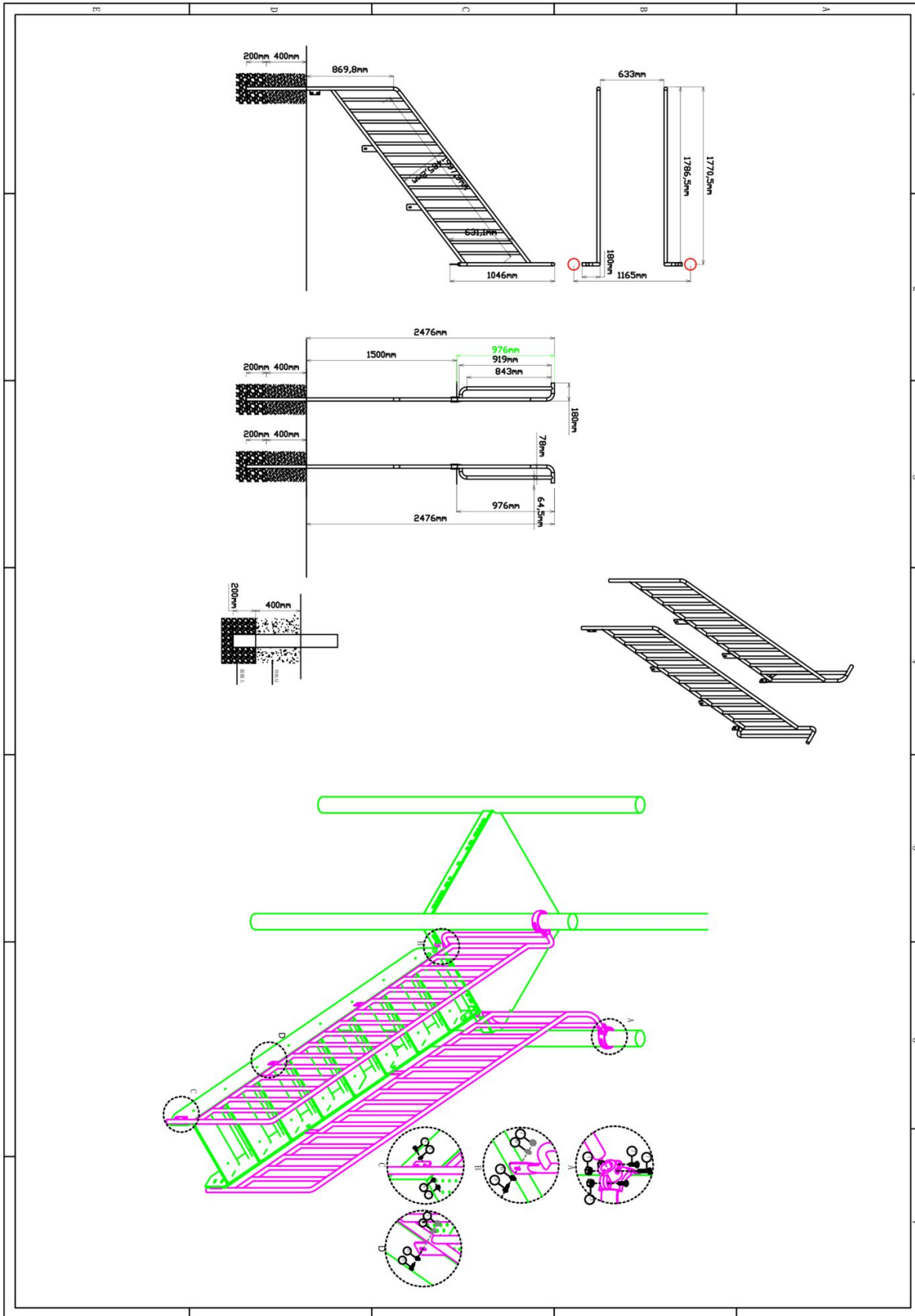





Hoofdafmetingen: 278x144x18cm

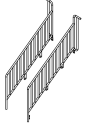

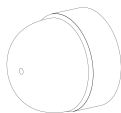
150cm trapleuningen HPL (2 stuks)

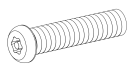
STAP 1 van 1

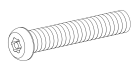
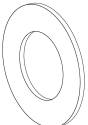
Omschrijving: Bevestiging van de trapleuning aan de vloer, staander en de trap

1 st. 150cm trapleuningen HPL (2 stuks)	2 st. Small clamp + ring	10 st. Afdekdop M10	2 st. Kruiskop M6X65
			1 
4 st. Torx M8X20	4 st. Lock Moer M8	2 st. Lock Moer M6	10 st. Torx M10X25
2 	3 	4 	5 
20 st. Ring M10 (middel)	10 st. Lock Moer M10		
6 	7 		

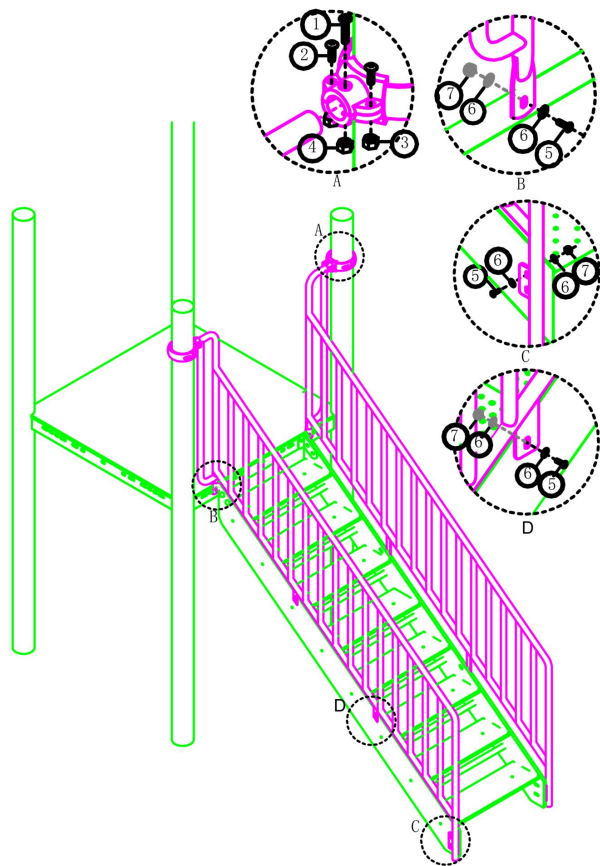

Bevestigings materiaal is per zakje verpakt en bovenstaande afbeelding zit in het zakje

Hekje tbv glijstang



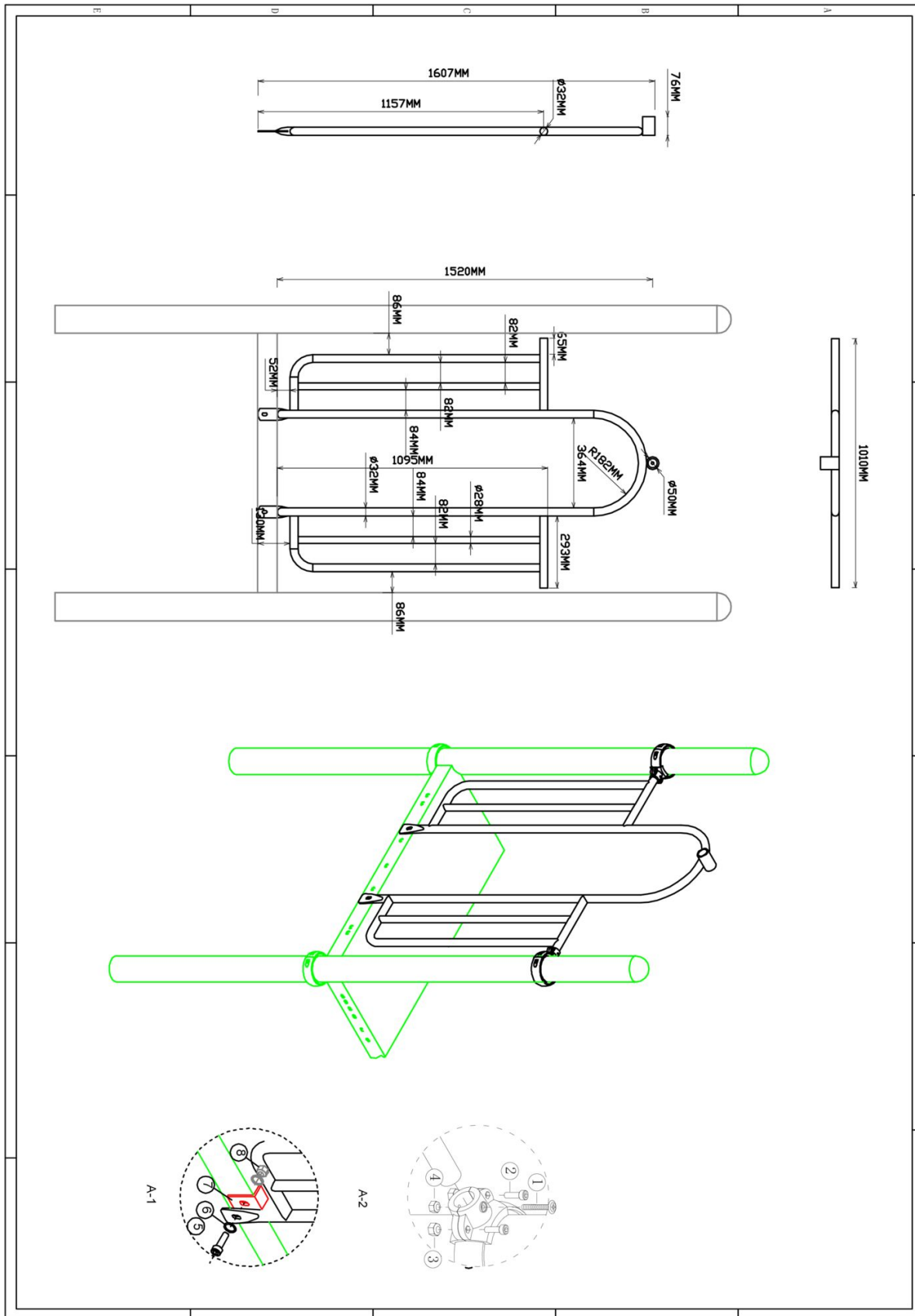





Hoofdafmetingen: 152x101cm

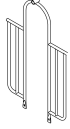

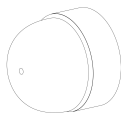
Hekje tbv glijstang

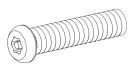
STAP 1 van 1

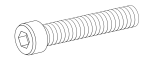
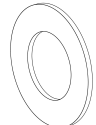
Omschrijving: Bevestiging van het hek tussen de vloer/staander

1 st. Hekje tbv glijstang	2 st. Small clamp + ring	2 st. Afdekdop M10	2 st. Kruiskop M6X65
			
4 st. Torx M8X20	4 st. Lock Moer M8	2 st. Lock Moer M6	2 st. Bout M10X25
			
4 st. Ring M10 (middel)	2 st. Hoekje	2 st. Lock Moer M10	
			

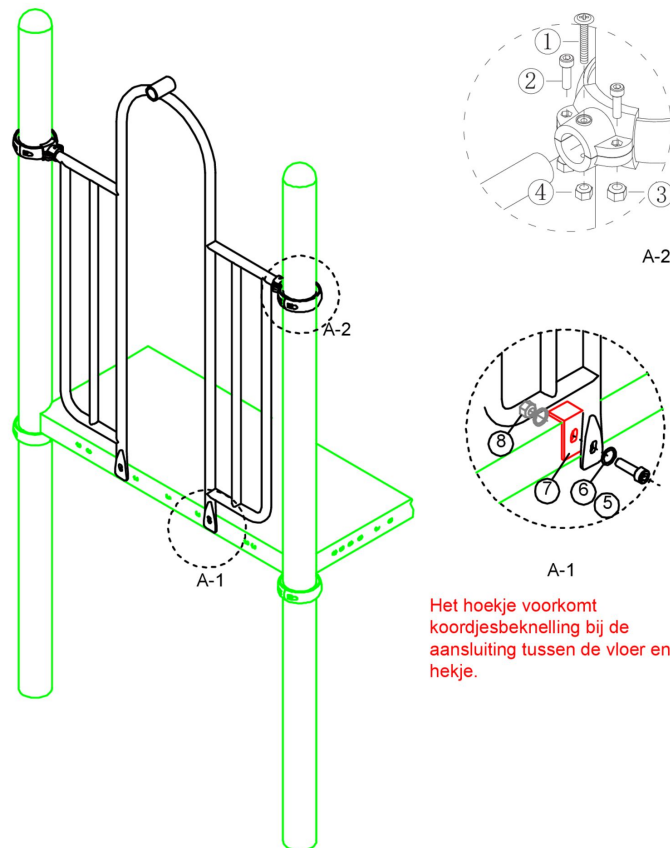

Het hoekje voorkomt koordjesbeknelling bij de aansluiting tussen de vloer en het hekje.

Bevestigings materiaal is per zakje verpakt en bovenstaande afbeelding zit in het zakje

150cm Glijstang

Hoofdafmetingen: 362x42cm

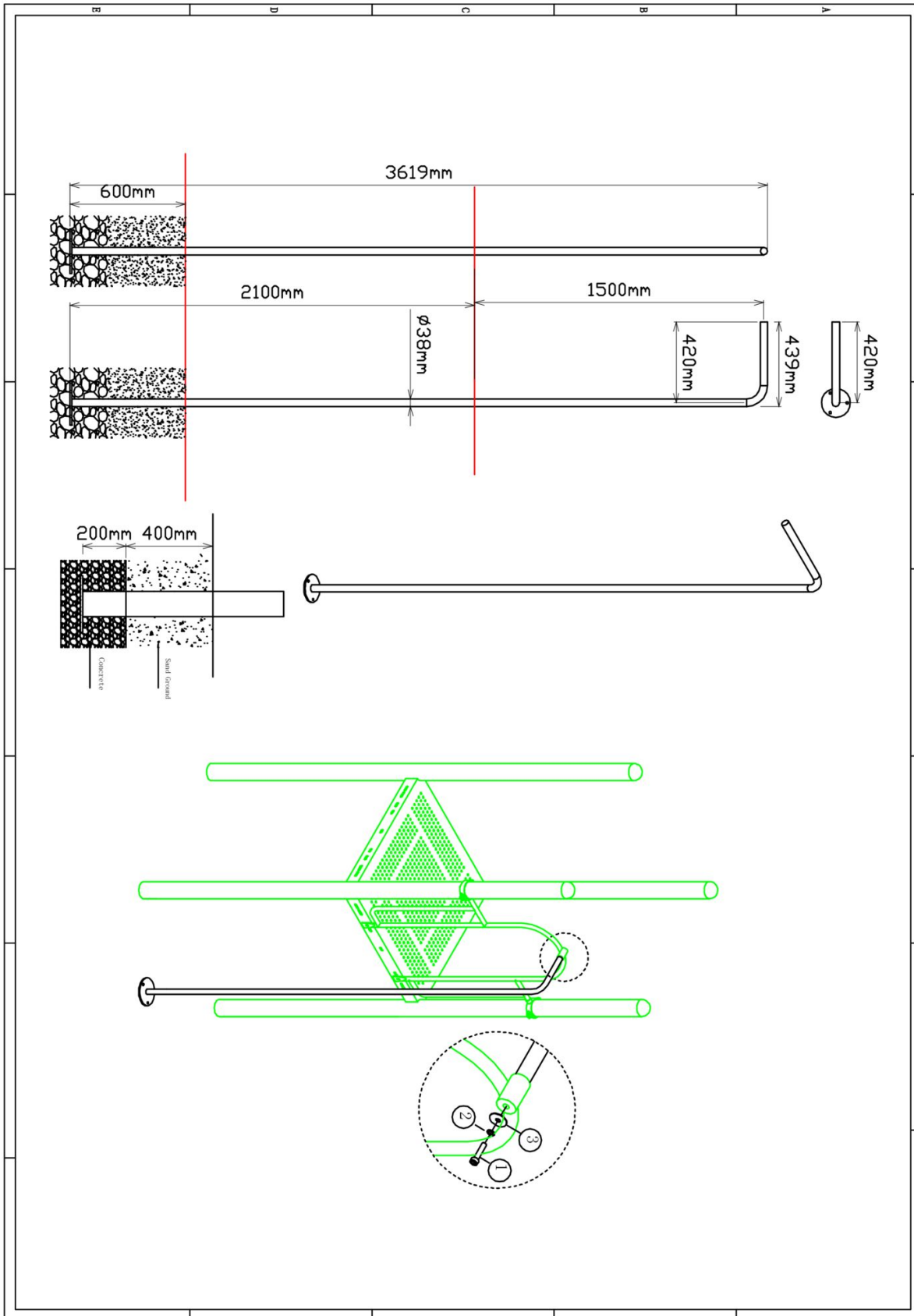

150cm Glijstang

STAP 1 van 1

Omschrijving: Bevestiging tussen de glijstang en het hek

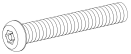
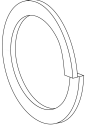
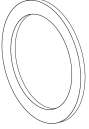
1 st. 150cm Glijstang	1 st. Torx M10X30	1 st. Veerring M10	1 st. Ring M10 (groot)
			

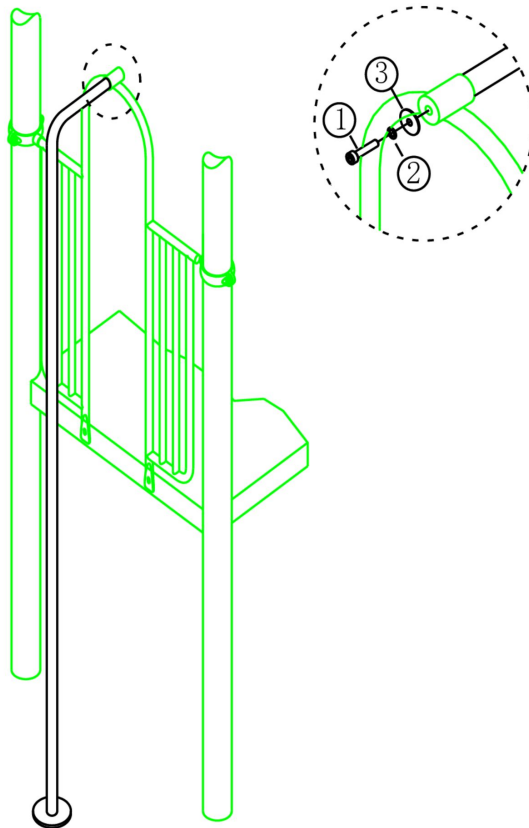

Bevestigings materiaal is per zakje verpakt en bovenstaande afbeelding zit in het zakje

Hekje tbv Snake climber



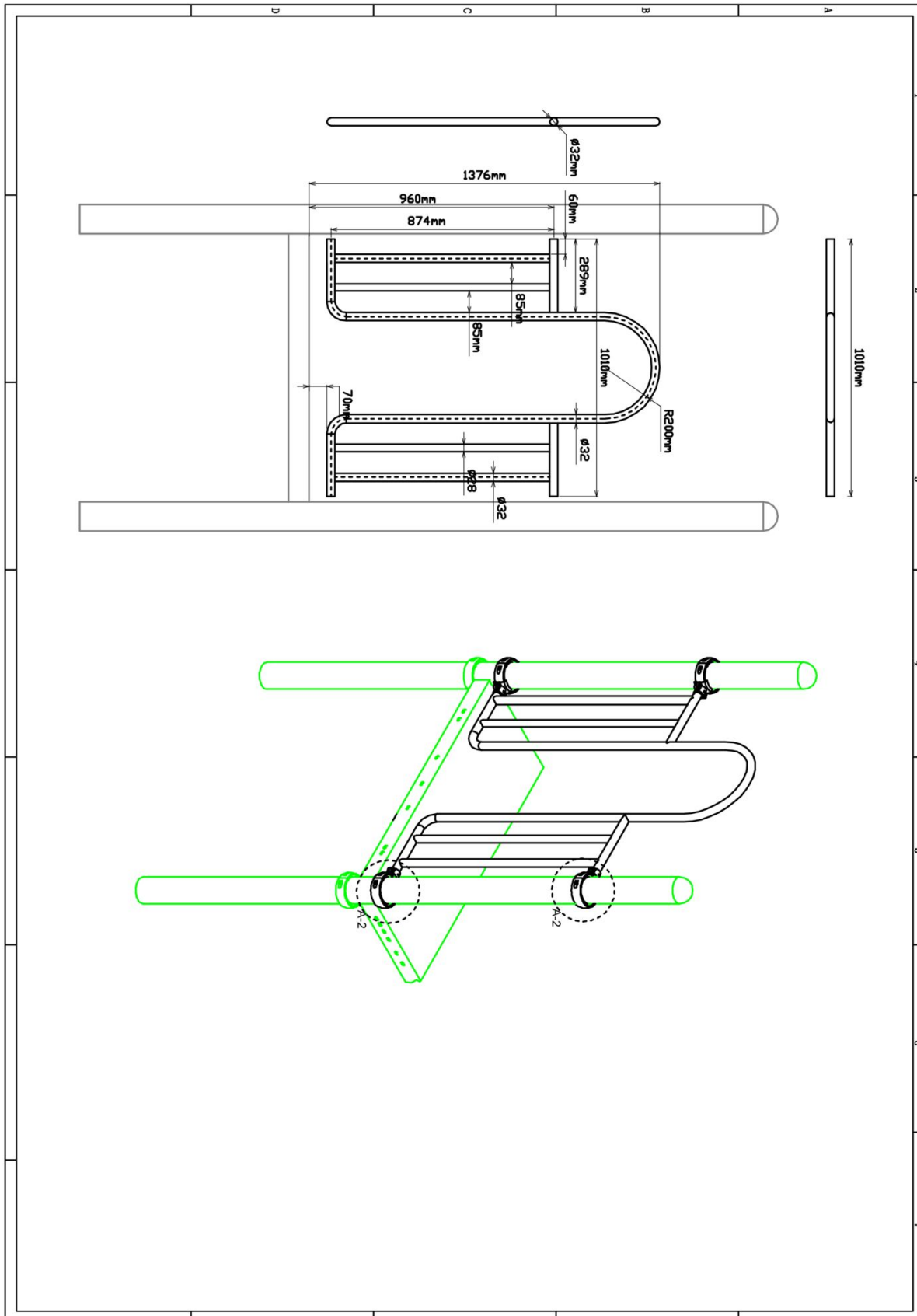

Hoofdafmetingen: 138x101cm

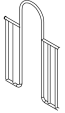

Hekje tbv Snake climber

STAP 1 van 1

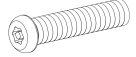
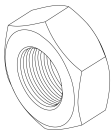
Omschrijving: Bevestiging van het paneel tussen de staanders

1 st. Hekje tbv Snake climber	4 st. Small clamp + ring	4 st. Kruiskop M6X65	8 st. Torx M8X20
		1 	2 
8 st. Lock Moer M8	4 st. Lock Moer M6		
3 	4 		

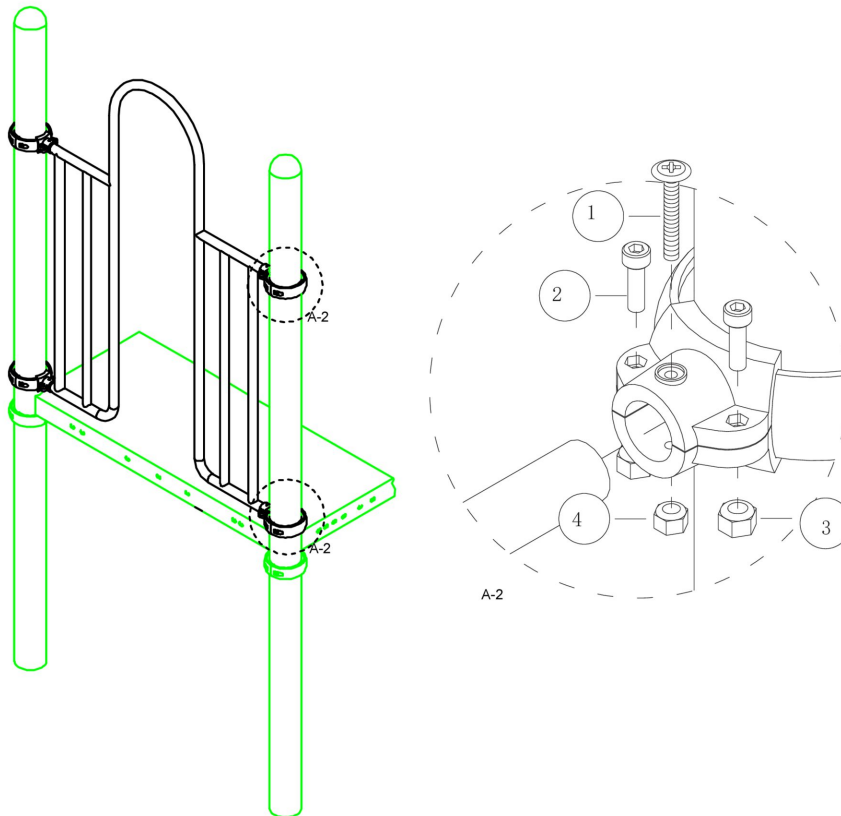

Bevestigings materiaal is per zakje verpakt en bovenstaande afbeelding zit in het zakje

150cm Snake climber

Hoofdafmetingen: 209x67cm

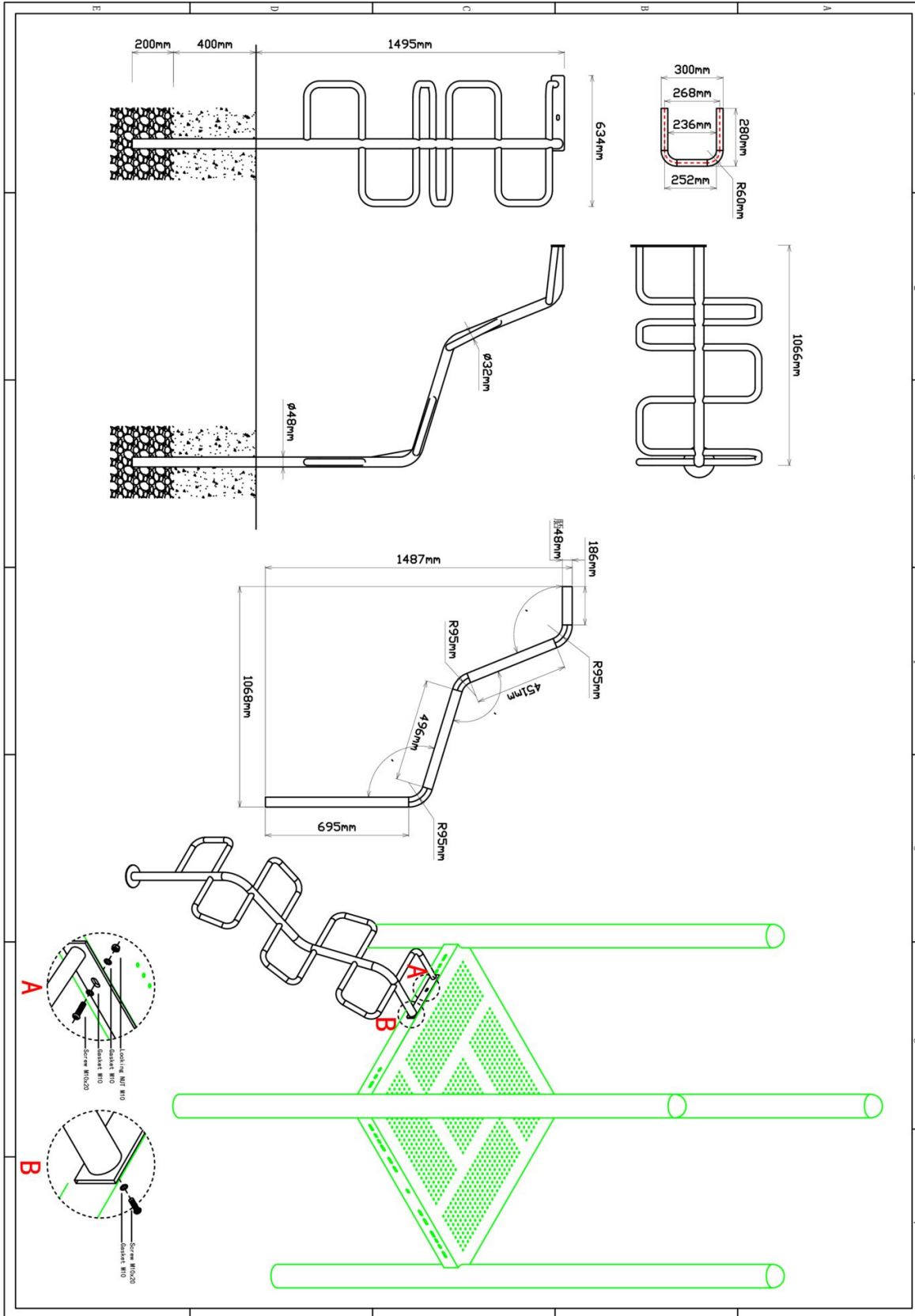

150cm Snake climber

STAP 1 van 1

Omschrijving: Bevestiging tussen snake climber en de vloer

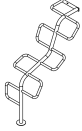
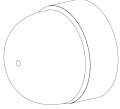
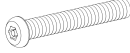
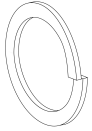
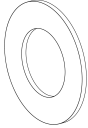
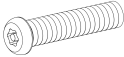
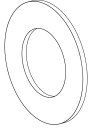
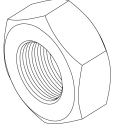
1 st. 150cm Snake climber	1 st. Afdekdop M10	1 st. Torx M10X30	1 st. Veerring M10
		1 	2 
1 st. Ring M10 (middel)	1 st. Torx M10X20	2 st. Ring M10 (middel)	1 st. Lock Moer M10
3 	4 	5 	6 

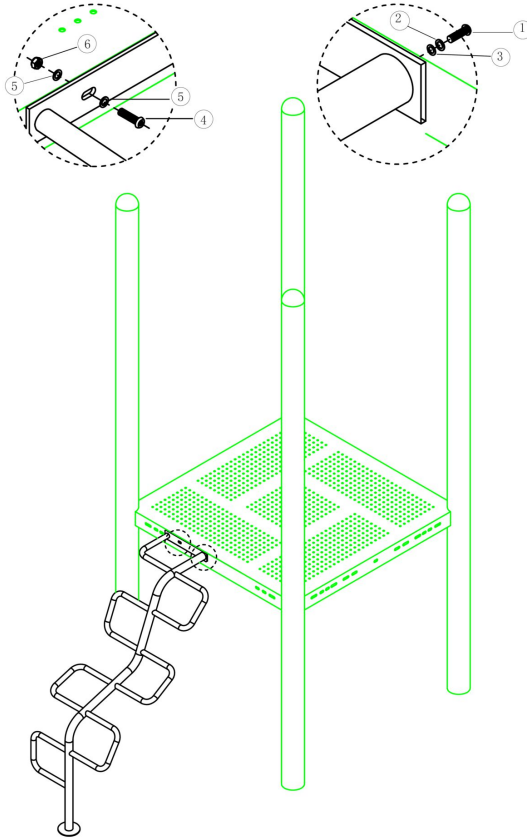





Bevestigings materiaal is per zakje verpakt en bovenstaande afbeelding zit in het zakje

Hekje tbv: B, Pod en Curly Climber

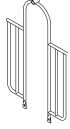
STAP 1 van 1

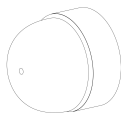
Omschrijving: Bevestiging van het hek tussen de vloer/staander

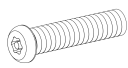
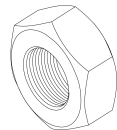
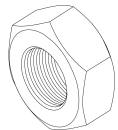
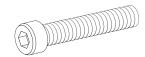
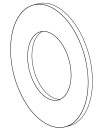
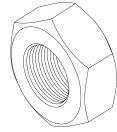
1 st. Hekje tbv: B, Pod en Curly Climber	2 st. Small clamp + ring	2 st. Afdekdop M10	2 st. Kruiskop M6X65
			① 
4 st. Torx M8X20	4 st. Lock Moer M8	2 st. Lock Moer M6	2 st. Bout M10X25
② 	③ 	④ 	⑤ 
4 st. Ring M10 (middel)	2 st. Lock Moer M10		
⑥ 	⑦ 		

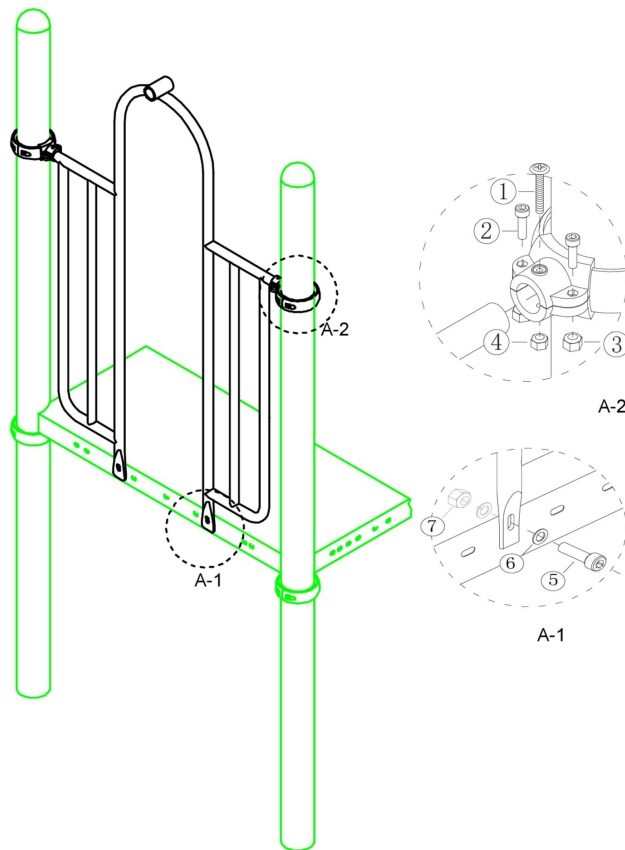

Bevestigings materiaal is per zakje verpakt en bovenstaande afbeelding zit in het zakje

150cm Pod climber

Hoofdafmetingen: 362x71cm

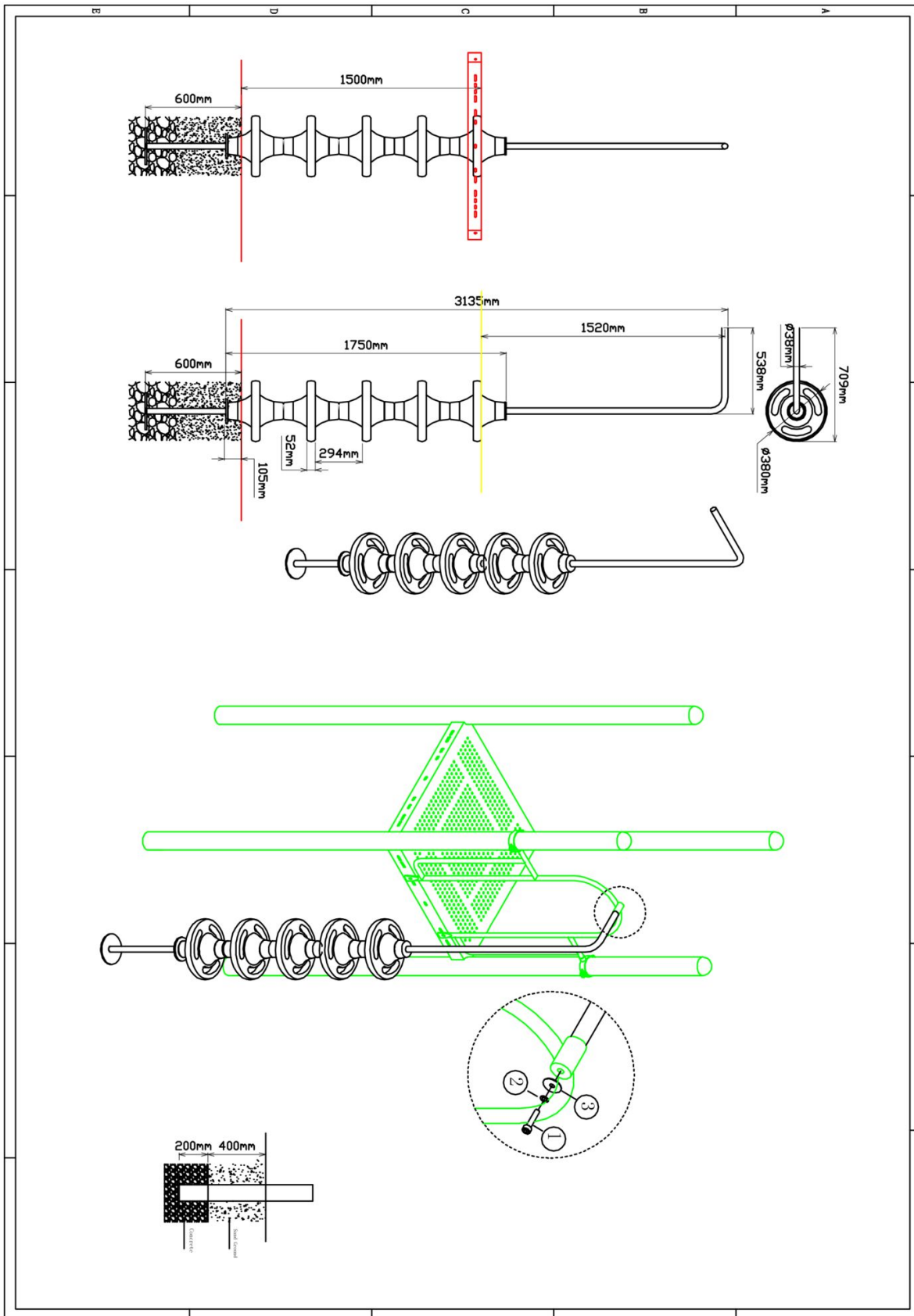

150cm Pod climber

STAP 1 van 1

Omschrijving: Bevestiging tussen hek en pod climber

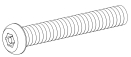
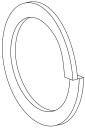
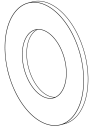
1 st. 150cm Pod climber	1 st. Torx M10X30	1 st. Veerring M10	1 st. Ring M10 (middel)
			

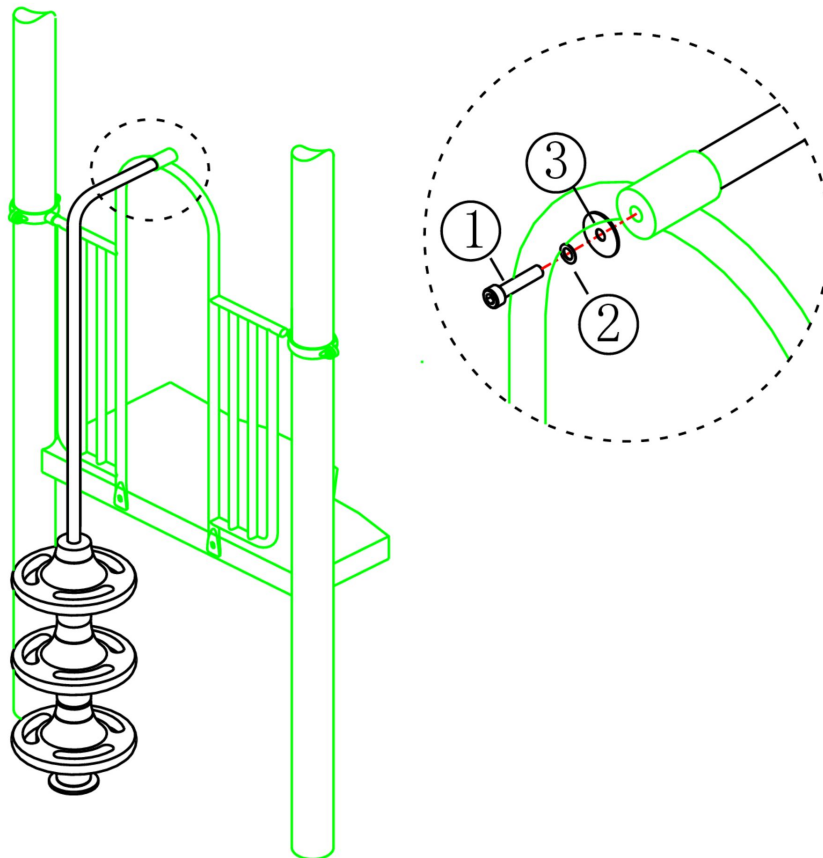

Bevestigings materiaal is per zakje verpakt en bovenstaande afbeelding zit in het zakje

Hek voor RVS glijbaan



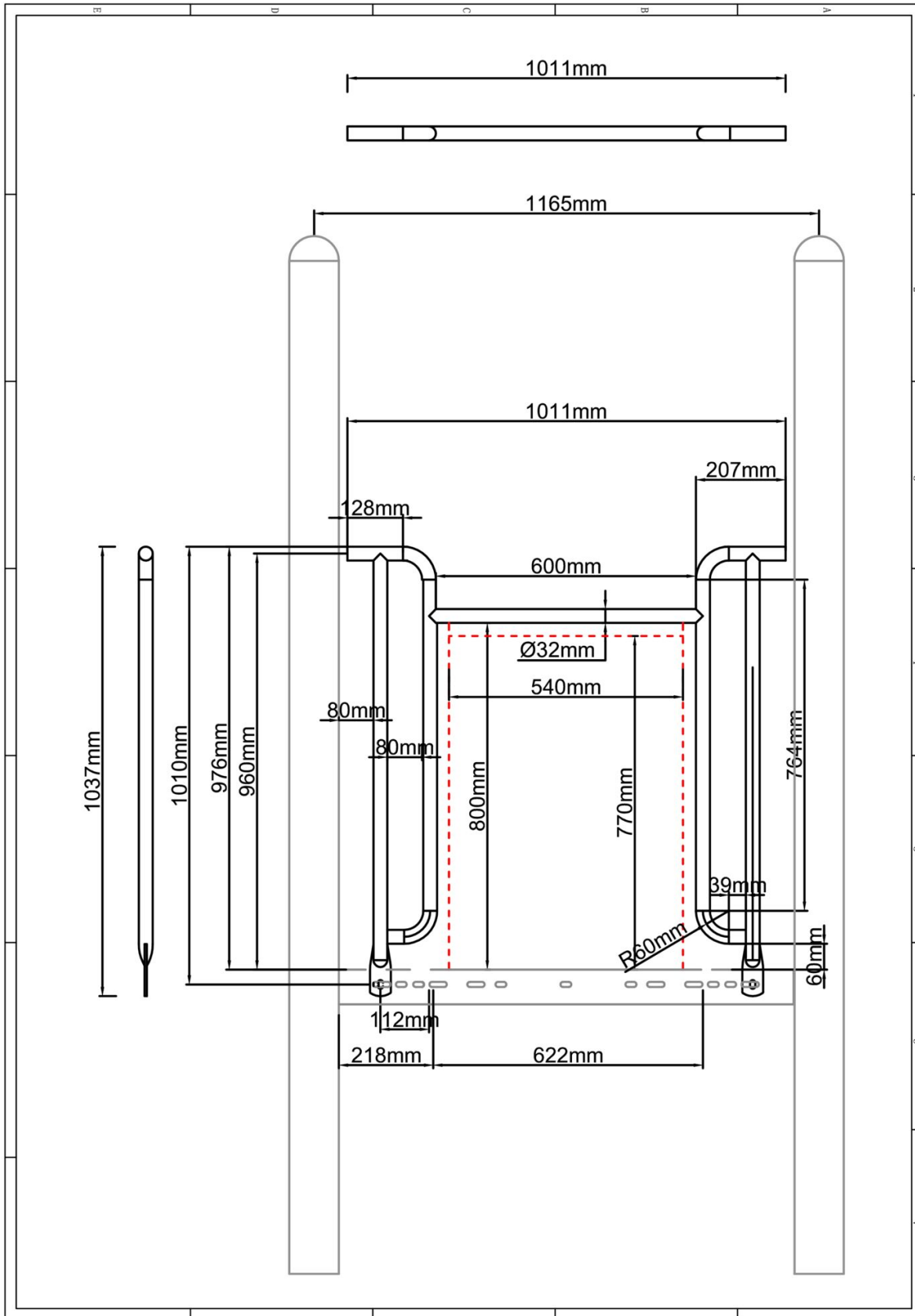

Hoofdafmetingen: 104x101cm

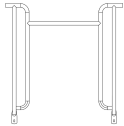

Hek voor RVS glijbaan

STAP 1 van 1

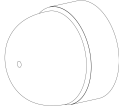
Omschrijving: Bevestiging tussen de vloer/staander en het hekje

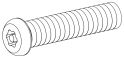
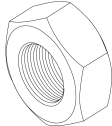
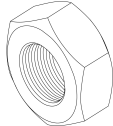
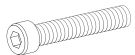
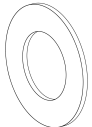
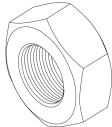
1 st. Hek voor RVS glijbaan	2 st. Small clamp + ring	2 st. Afdekdop M10	2 st. Kruiskop M6X65
			① 
4 st. Torx M8X20	4 st. Lock Moer M8	4 st. Lock Moer M6	2 st. Bout M10X25
② 	③ 	④ 	⑤ 
4 st. Ring M10 (middel)	2 st. Lock Moer M10		
⑥ 	⑦ 		

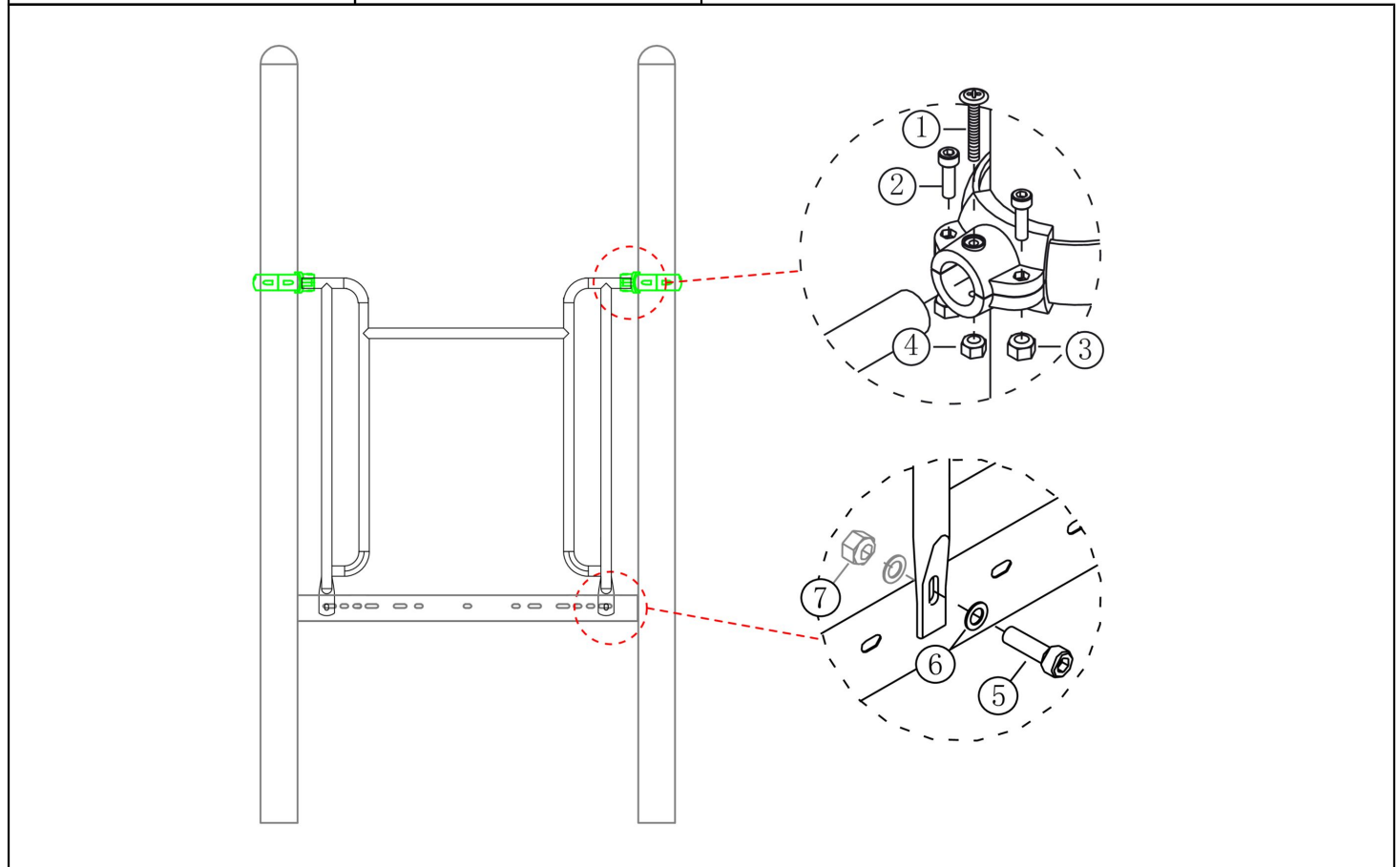

Bevestigings materiaal is per zakje verpakt en bovenstaande afbeelding zit in het zakje

RVS Glijbaan 150cm

Hoofdafmetingen: 250x297x54cm

alle afmetingen zijn in mm.

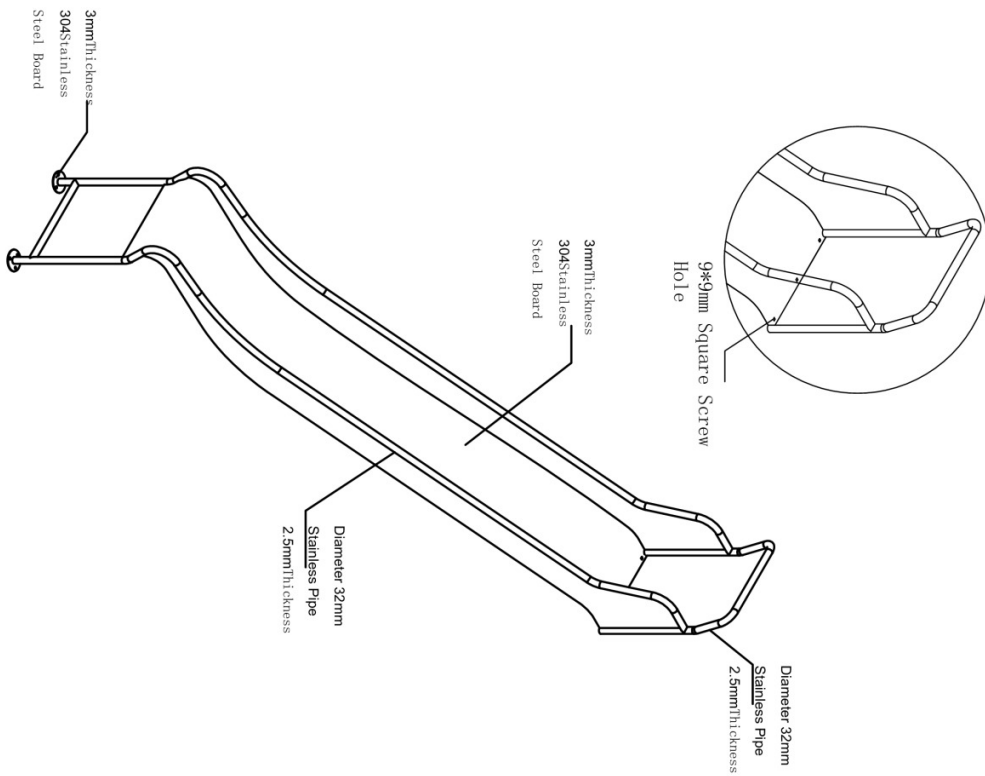
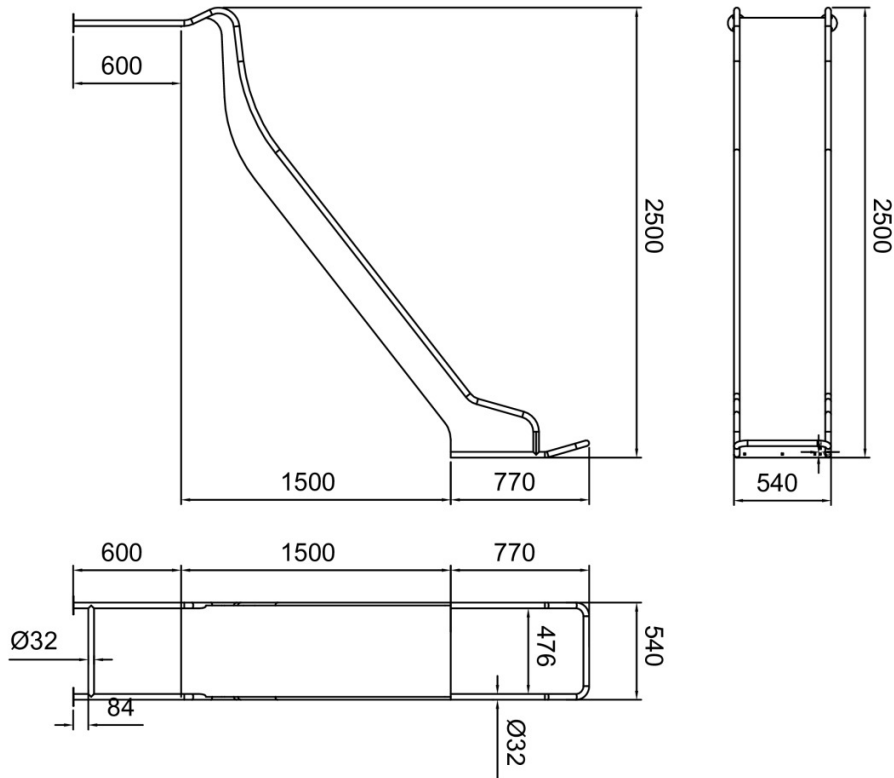

1500mm Slide

RVS Glijbaan 150cm

STAP 1 van 2

Omschrijving: Bevestigings gaten in de vloer boren volgens schema

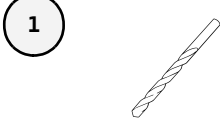
1 st. Boormachine	1 st. Boortje 8,5mm
	

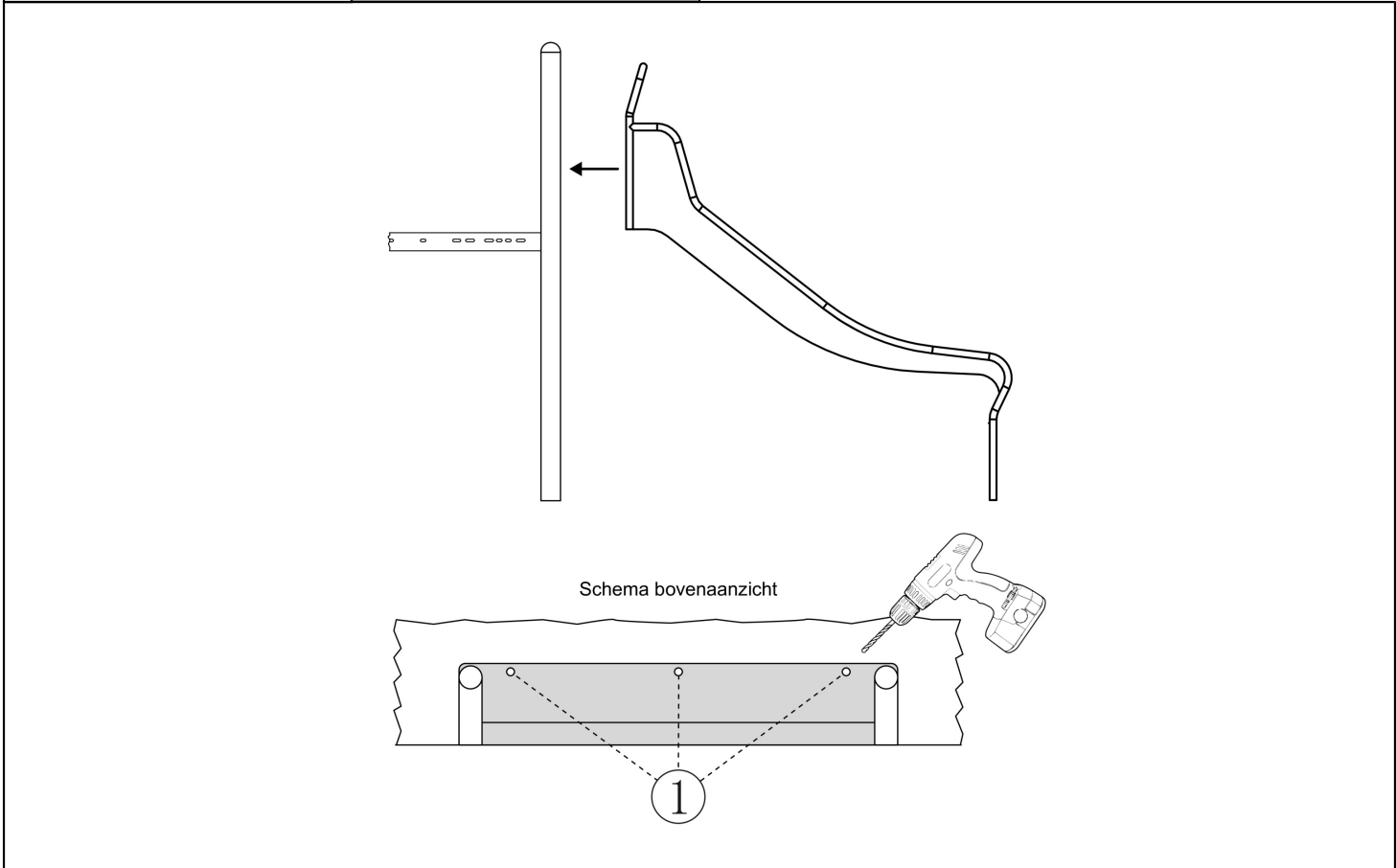

Bevestigings materiaal is per zakje verpakt en bovenstaande afbeelding zit in het zakje

RVS Glijbaan 150cm

STAP 2 van 2

Omschrijving: Glijbaan op de vloer bevestigen met bijgeleverde montagepakket.

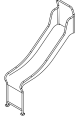
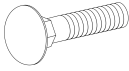
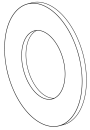
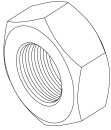
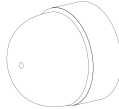
1 st. RVS Glijbaan 90cm	2 st. Slotbout M8X20	
		
2 st. Ring M8 (middel)	2 st. Lock Moer M8	2 st. Afdekdop M8
		

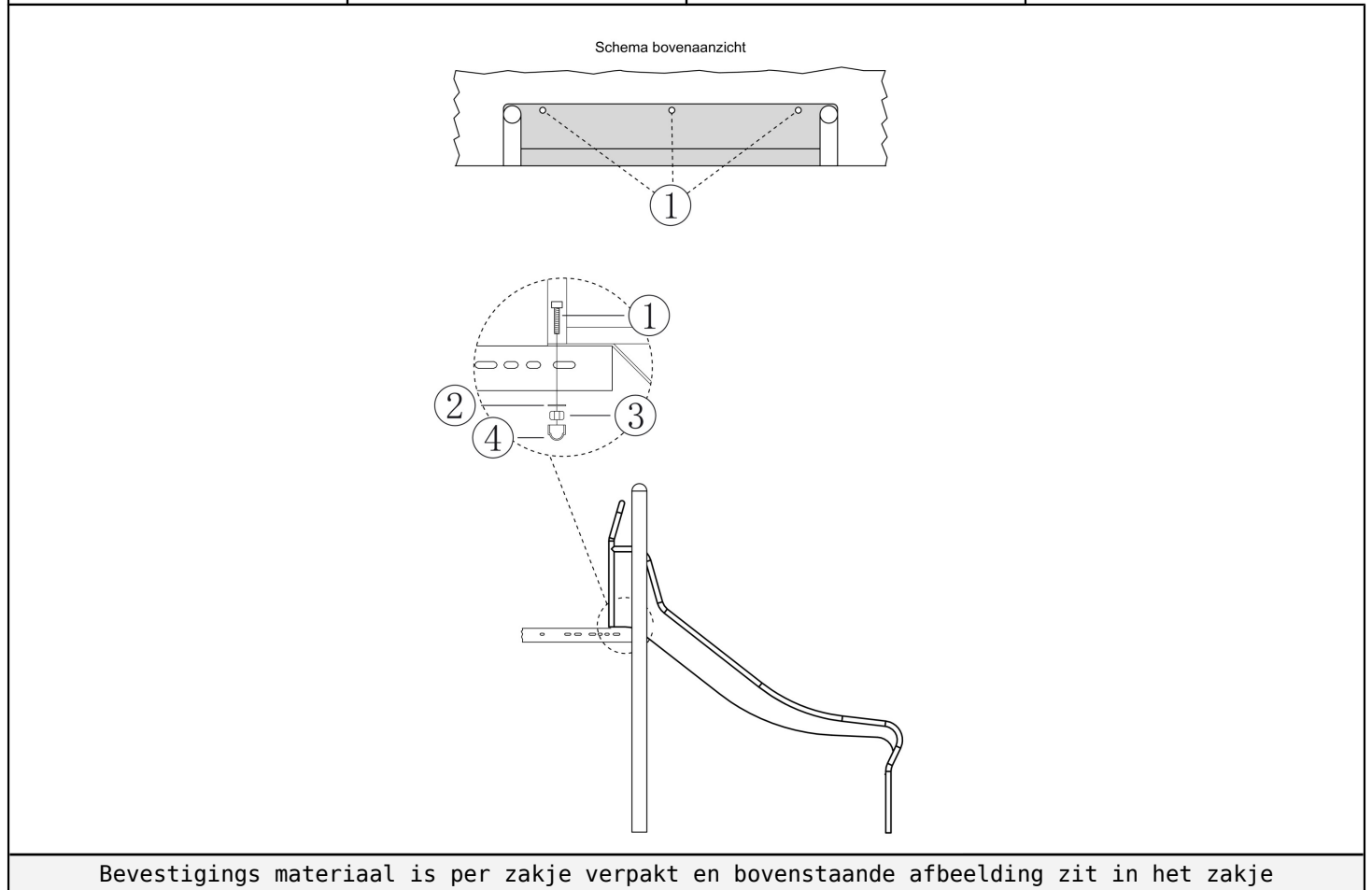

Bankje 2.0

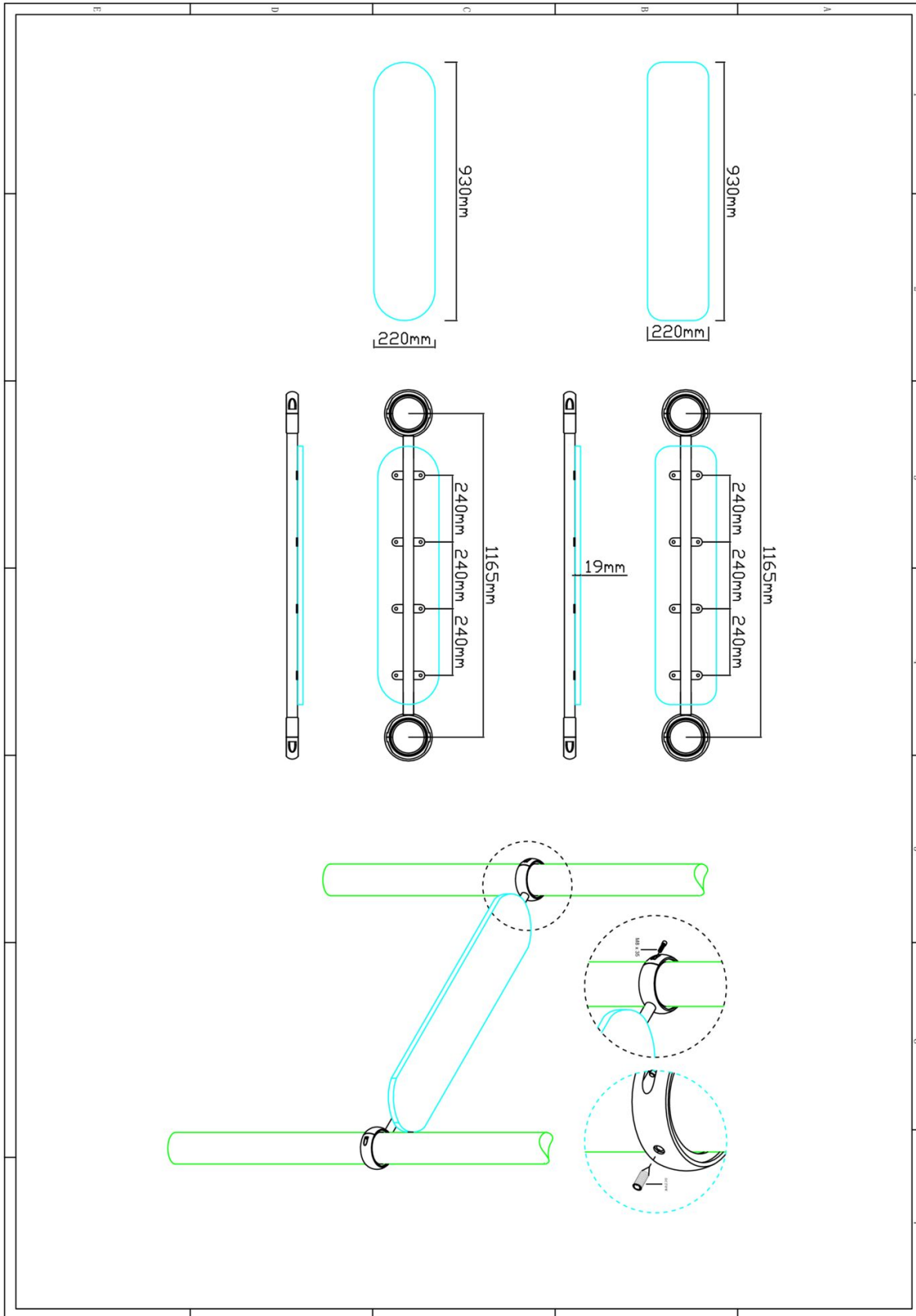

Hoofdafmetingen: 116x22x4cm



Bankje 2.0

STAP 1 van 1

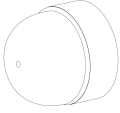
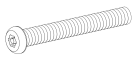
Omschrijving: Bevestiging tussen de standers en de bank

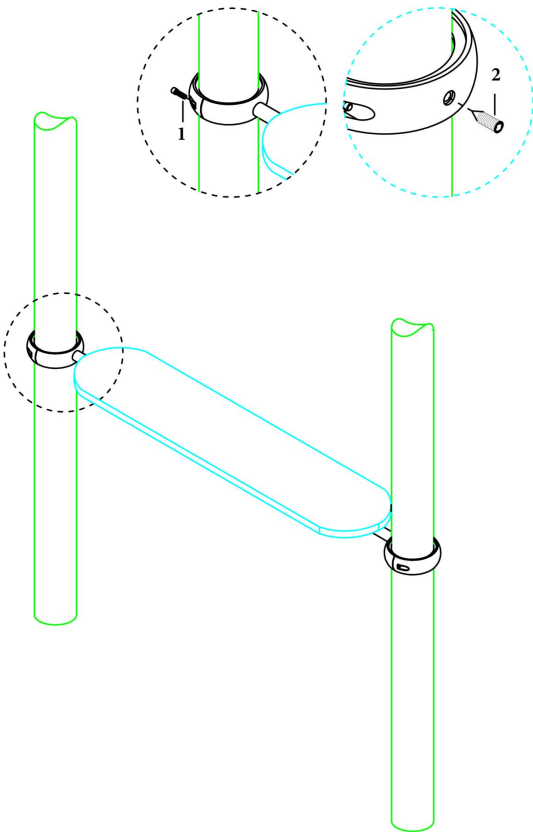
1 st. Bankje 2.0	8 st. Afdekdop M8	4 st. Torx M8X35	2 st. Inbus stelschroef M10x20
		<p>1</p> 	<p>2</p> 
			
<p>Bevestigings materiaal is per zakje verpakt en bovenstaande afbeelding zit in het zakje</p>			