

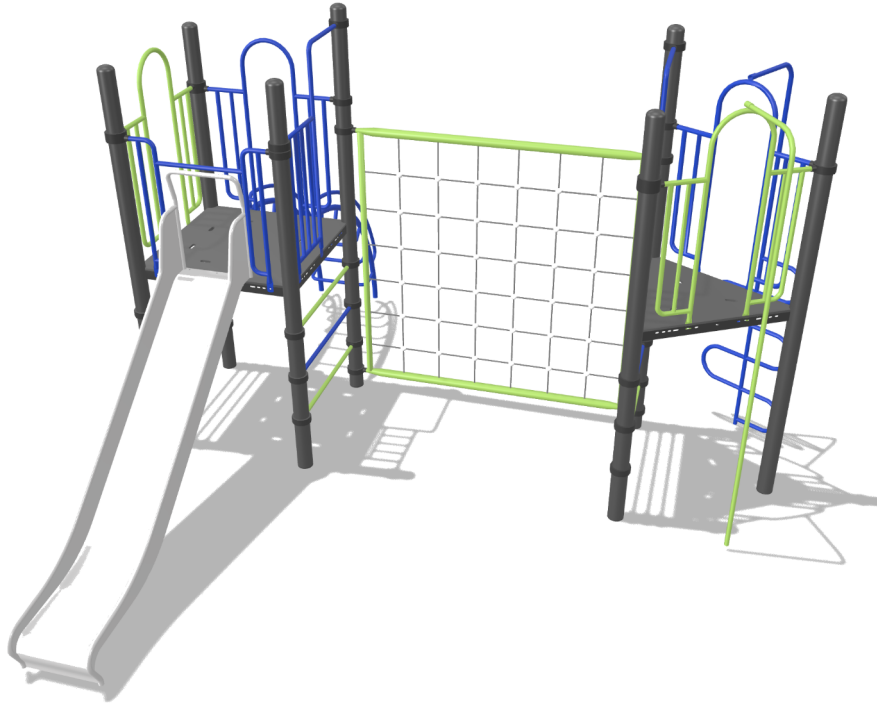

TnT speeltoestellen

Montagehandleiding

3do-543



Toestel	3do-543
Datum montagehandleiding	21-05-2026

Beste klant van TnT Speeltoestellen,

Wij danken u voor het aanschaffen en installeren van een speeltoestel van TnT Speeltoestellen. Wij waarderen het vertrouwen dat u in ons bedrijf heeft geplaatst en streven ernaar om uw vertrouwen meer dan waar te maken!

Dit is uw TnT speeltoestellen montagehandleiding.

Wij hebben deze handleiding specifiek voor het product ontworpen, waarop eveneens de toe te passen onderdelen zijn genoemd.

Ook vindt u het grondplan met de benodigde valruimte volgens norm NEN-EN1176-1 : 2017.

Bewaart u dit document bij uw logboek. Nogmaals willen wij u bedanken voor de aankoop van dit speeltoestel. Wij zien uit naar uw volgende speelproject.

Met vriendelijke groet, TnT Speeltoestellen

Inhoudsopgave

Aanzichten 3D	2
Onderdelenlijst	4
Veiligheidsruimtes	5
Zijaanzichten	6
Plattegrond palenplan	8
Paalmaten	9
Paaldata	10
Onderdeel handleidingen	11
Staander 370cm	12
Staander 350cm	14
Vloer gelijke driehoek (vloer_driehoek_gelijk)	16
Vloer vierkant (vloer_vierkant)	18
Klimnet (klimnet)	20
Opgang slang (b-klimmer_150cm)	30
Half ronde opgang (klimrek_150cm_boog)	34
Glijstang (glijstang_150cm)	38
Opgang stangen (opgang_stangen_150cm)	42
Glijbaan RVS (glijbaan_150cm_metaal)	48

Aanzichten 3D

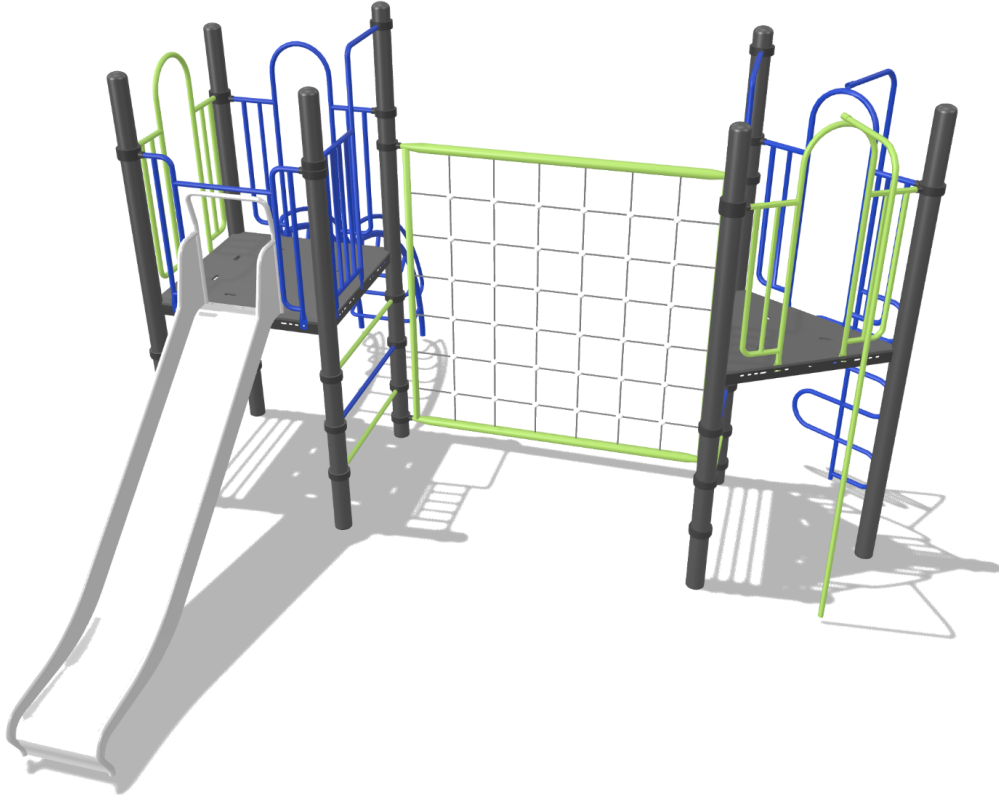

Aanzicht 1

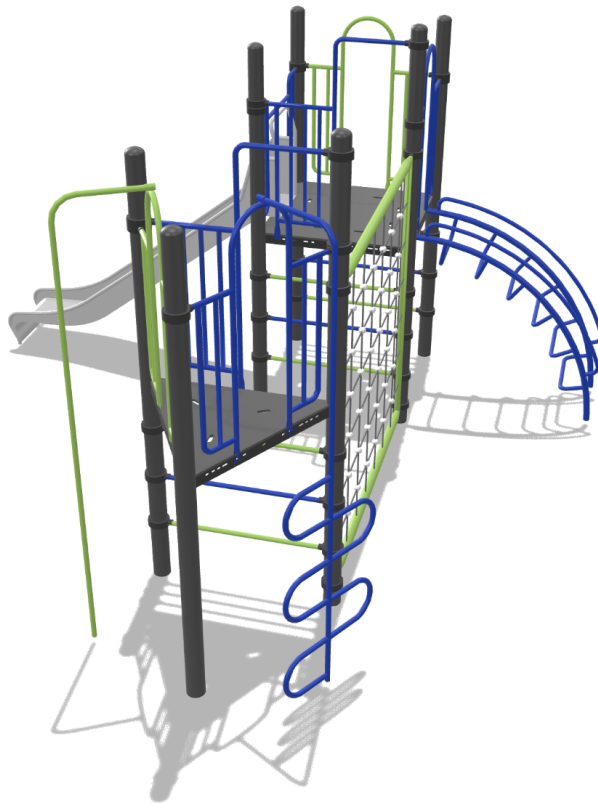

Aanzicht 2

Aanzichten 3D

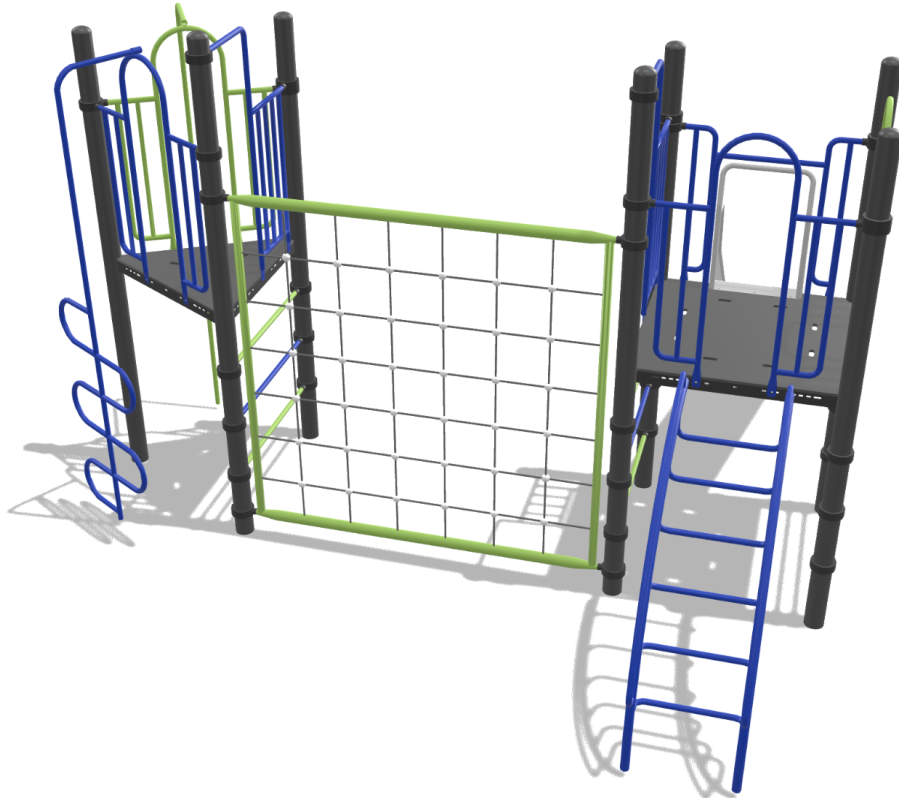



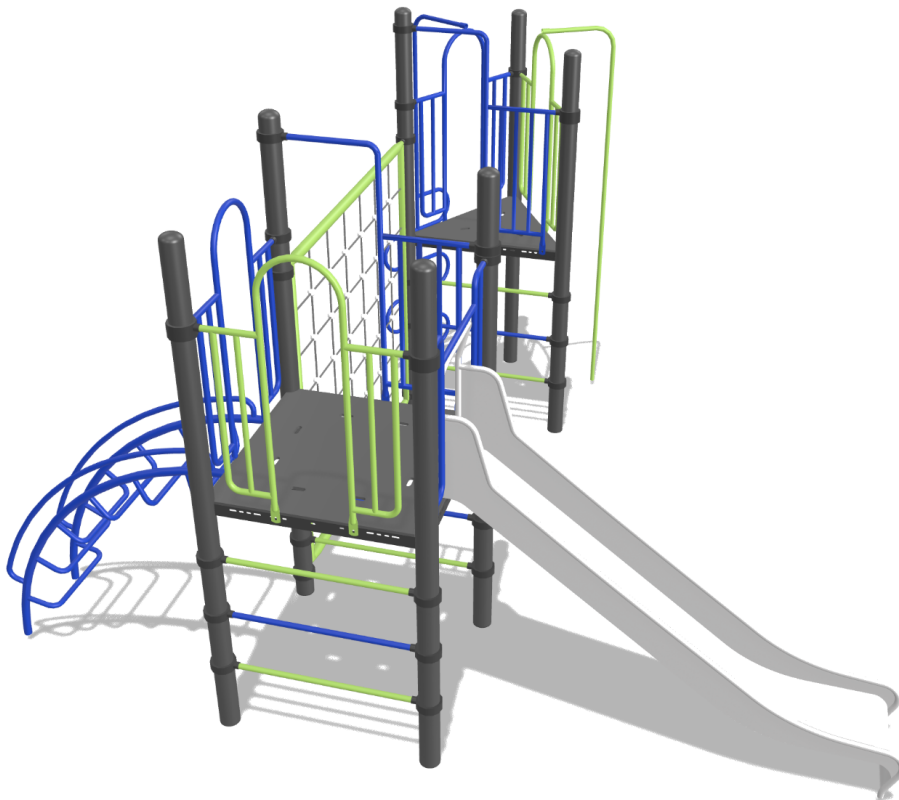



Aanzicht 3

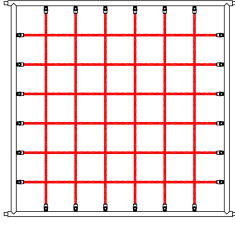
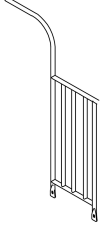
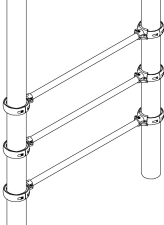
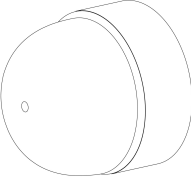
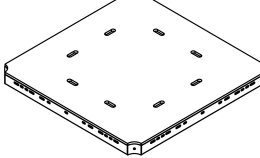
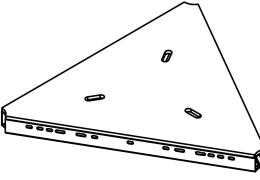
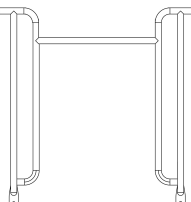
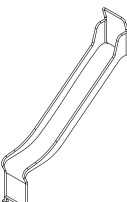
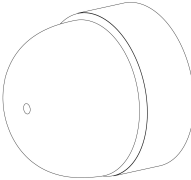
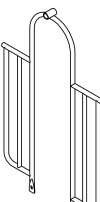

Aanzicht 4

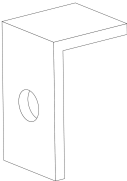
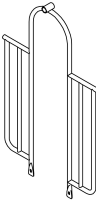
Onderdelenlijst

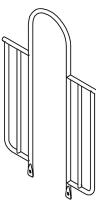
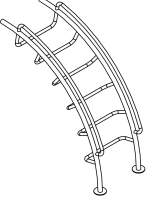
<p>2x Staander 370cm 370x11,5cm</p> 	<p>5x Staander 350cm 350x11,5cm</p> 	<p>1x Klimnet 233cm 218x200cm</p> 	<p>2x Hek voor klimnet metaal 157x53cm</p> 
<p>3x Stangenopgang 150cm 3,2x101 (stang 3x)</p> 	<p>36x Afdekdop M10 M10</p> 	<p>1x Vloer vierkant HPL 117x117x8,5cm</p> 	<p>1x Vloer gelijke driehoek HPL 116,5x116,5x8,5cm</p> 
<p>1x Hek voor RVS glijbaan 104x101cm</p> 	<p>1x RVS Glijbaan 150cm 250x297x54cm</p> 	<p>2x Afdekdop M8 M8</p> 	<p>1x Hekje tbv glijstang 152x101cm</p> 
<p>1x 150cm Glijstang 362x42cm</p> 	<p>2x Hoekje</p> 	<p>1x Hekje tbv: B, Pod en Curly Climber 152x101cm</p> 	<p>1x 150cm B climber 362x44cm</p> 
<p>2x Hekje zonder bevestiging (boven) 152x101cm</p> 	<p>1x 150cm Arch climber 217x150x73cm</p> 		

Veiligheidsruimtes

Geachte klant,

Zorg er altijd voor dat alle veiligheidsruimtes zoals aangegeven in ieder geval gehaald worden, dit zijn de minimale vereiste ruimtes voor een veilig gebruik van het speeltoestel.

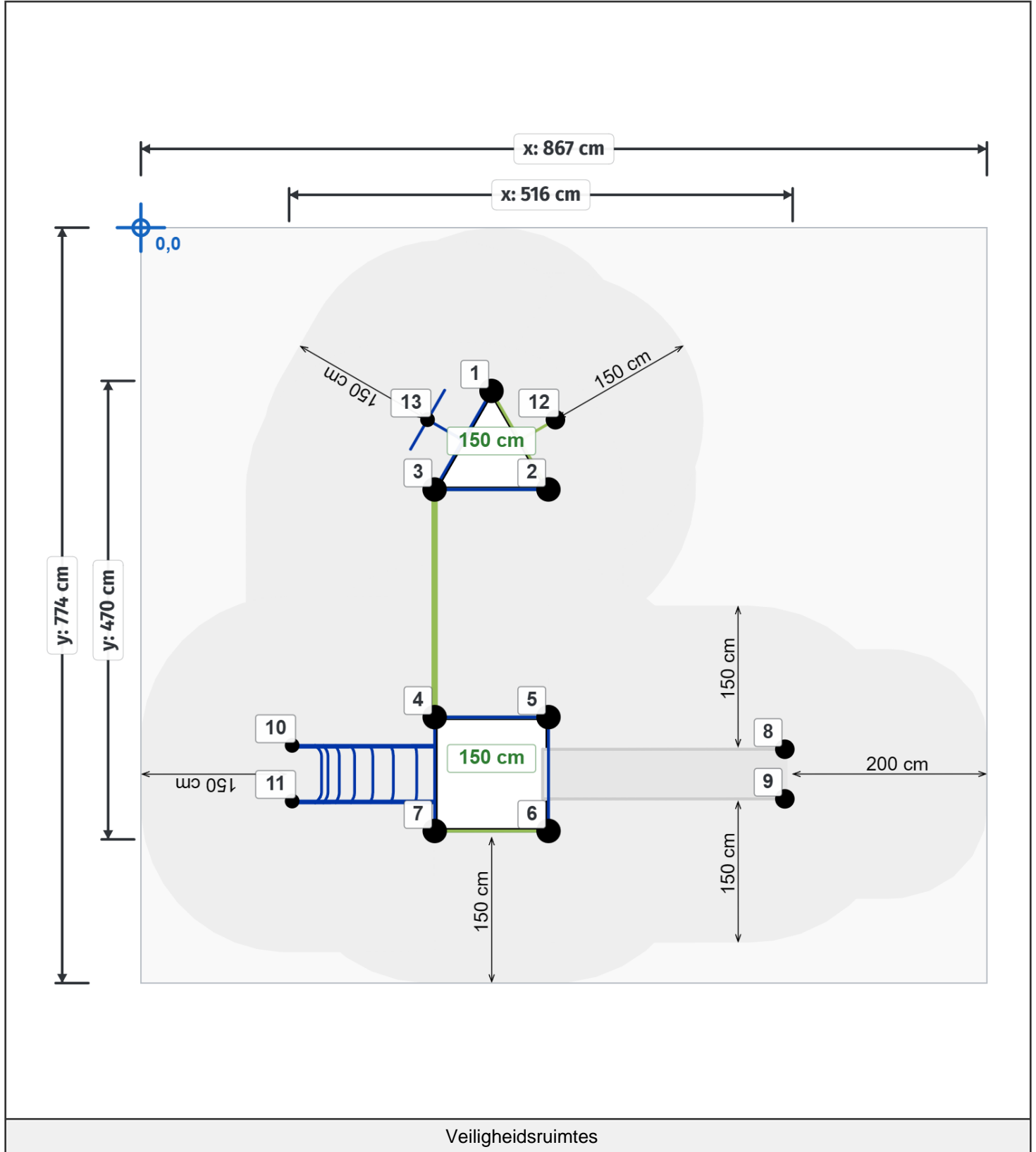

Zijaanzichten

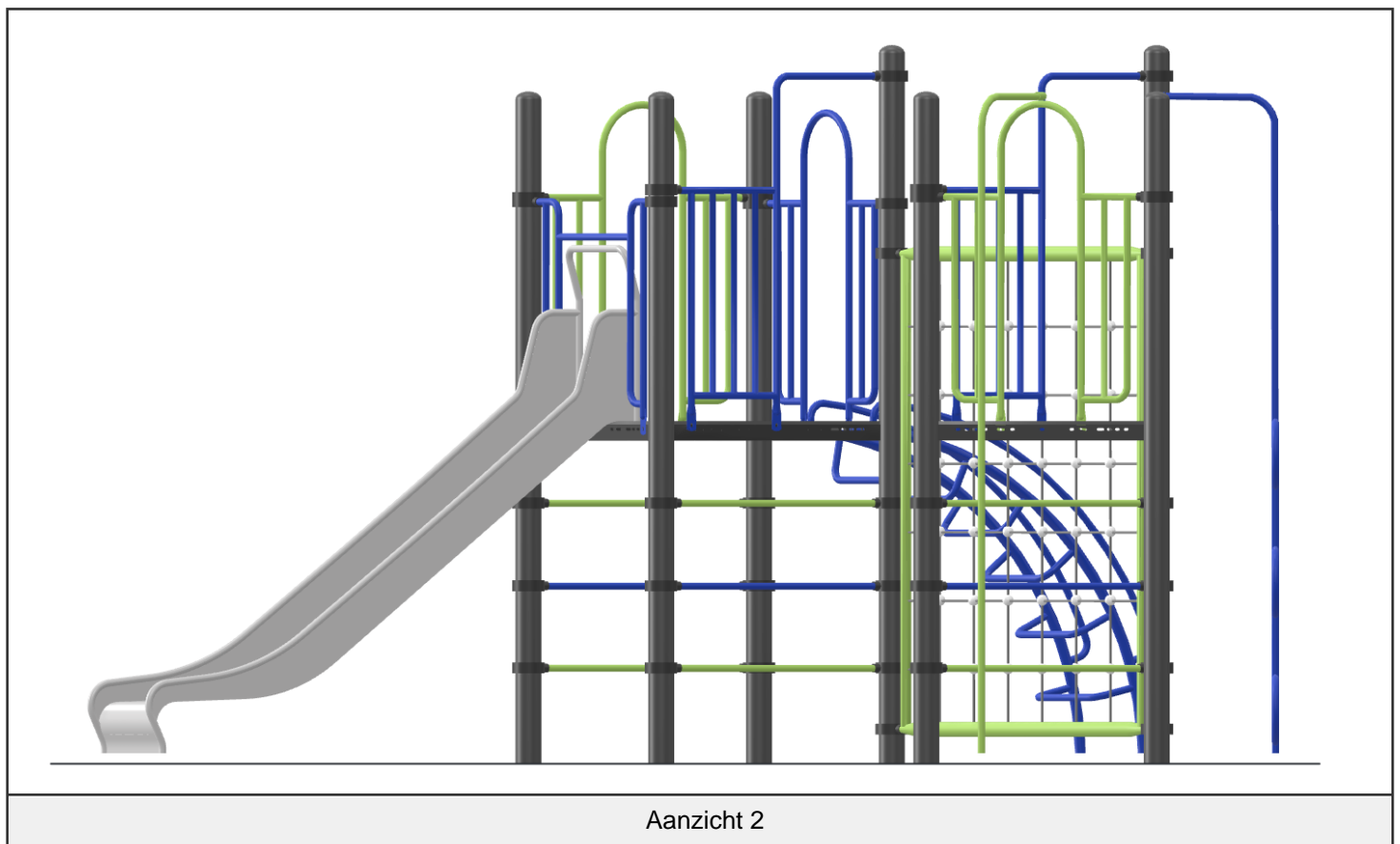
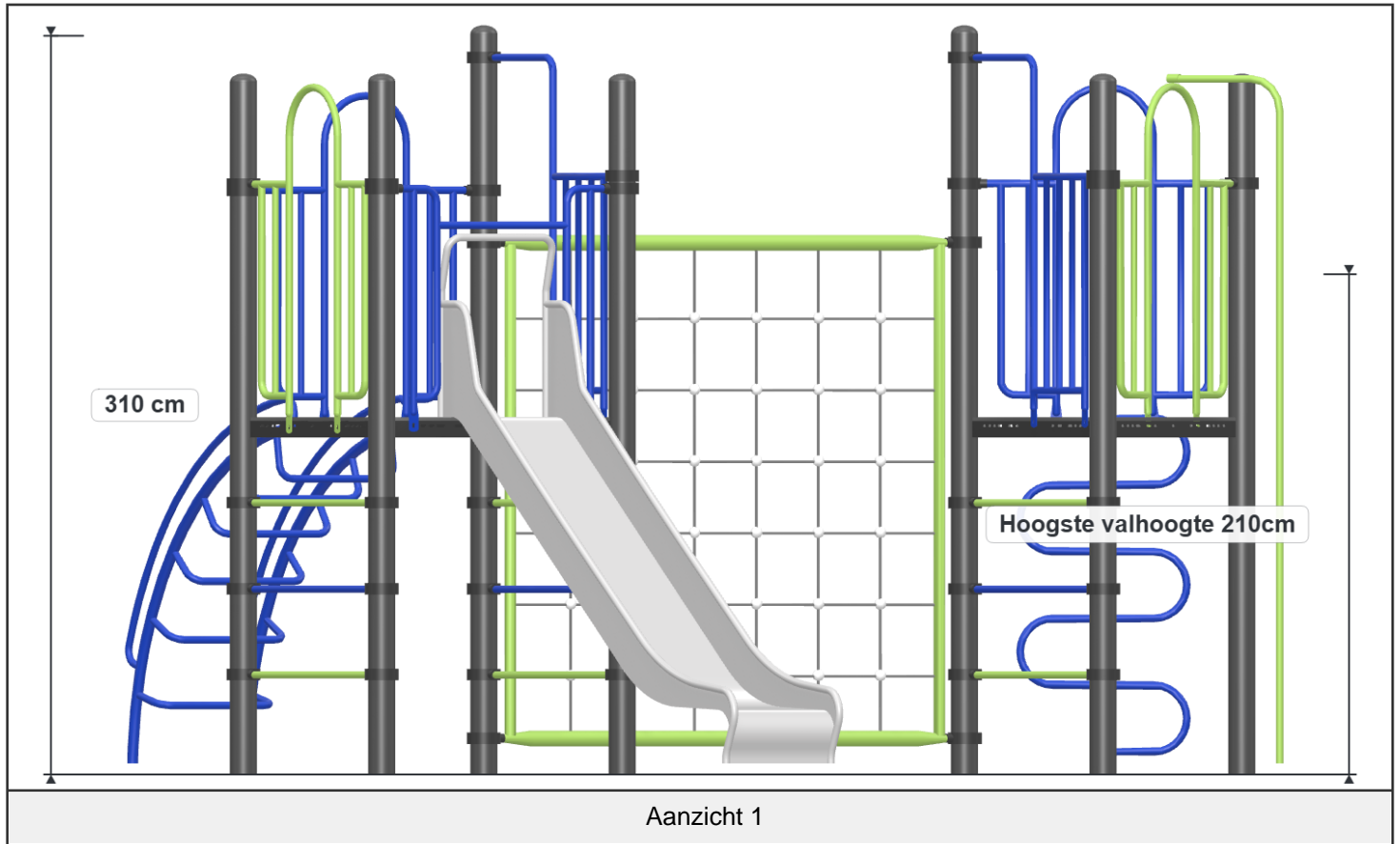

Zijaanzichten

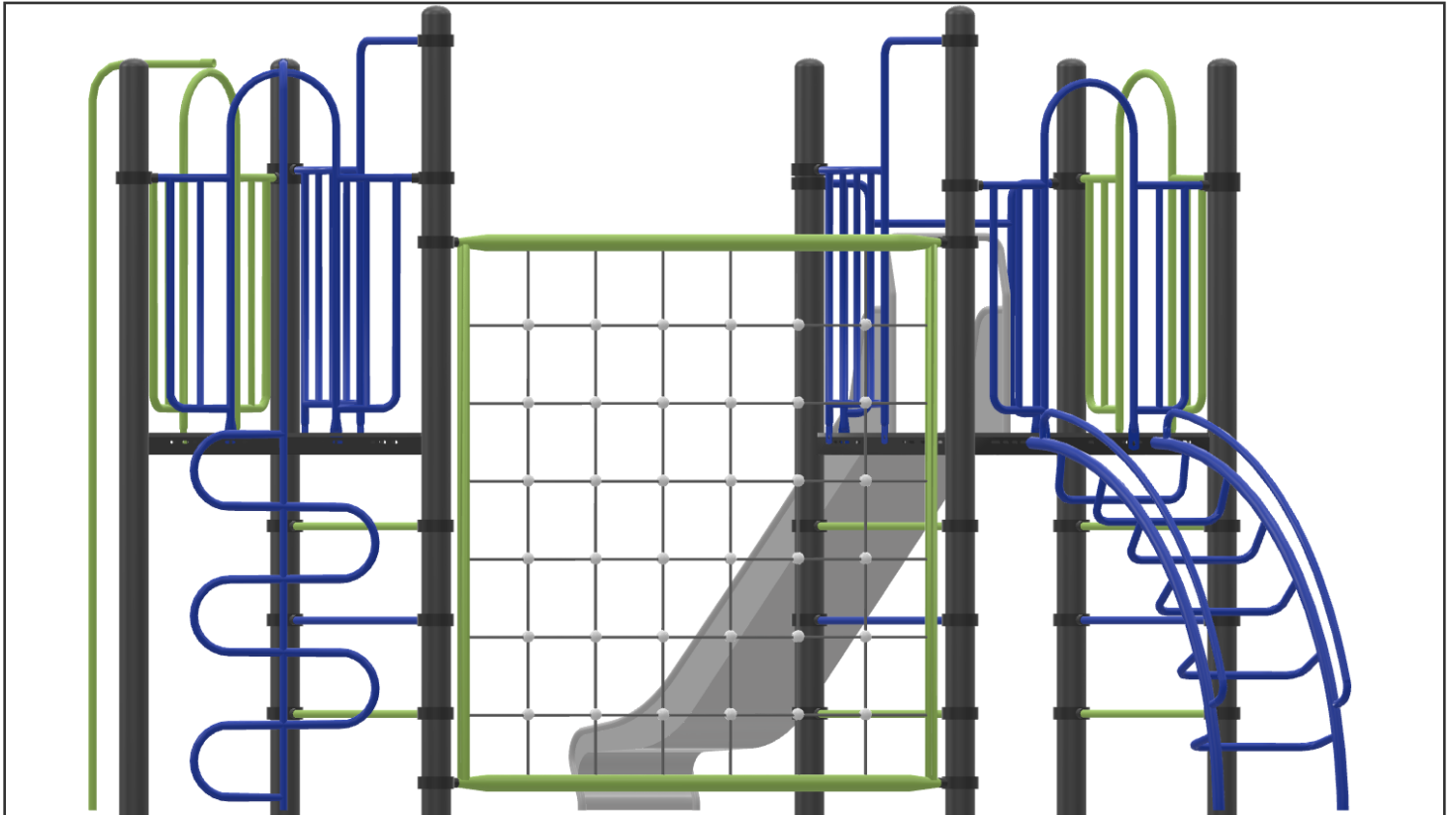

Aanzicht 3

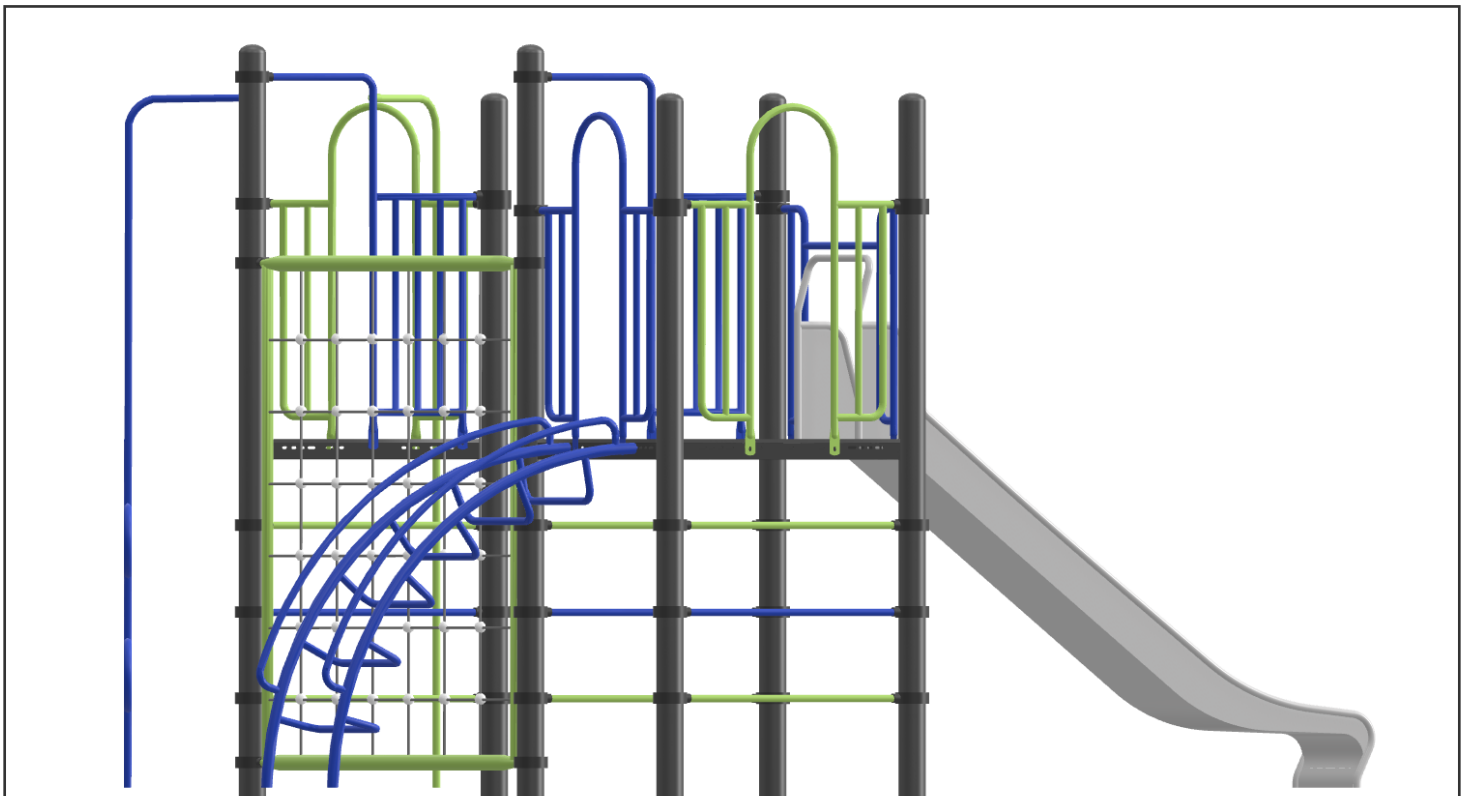

Aanzicht 4

Plattegrond palenplan

U kunt van deze tekening niet afmeten!

Voor de betonfundatie heeft u 37,5 kg snelbeton per staander nodig.

Voor de overige onderdelen (Glijstangen, Climbers, Glijbaan voeten) 25 kg snelbeton.

Houdt u er rekening mee dat de betonfundatie minimaal 400mm onder het maaiveld blijft, zoals op de tekening afgebeeld.

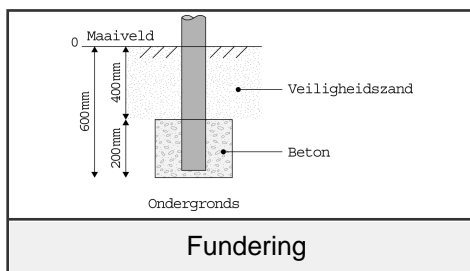
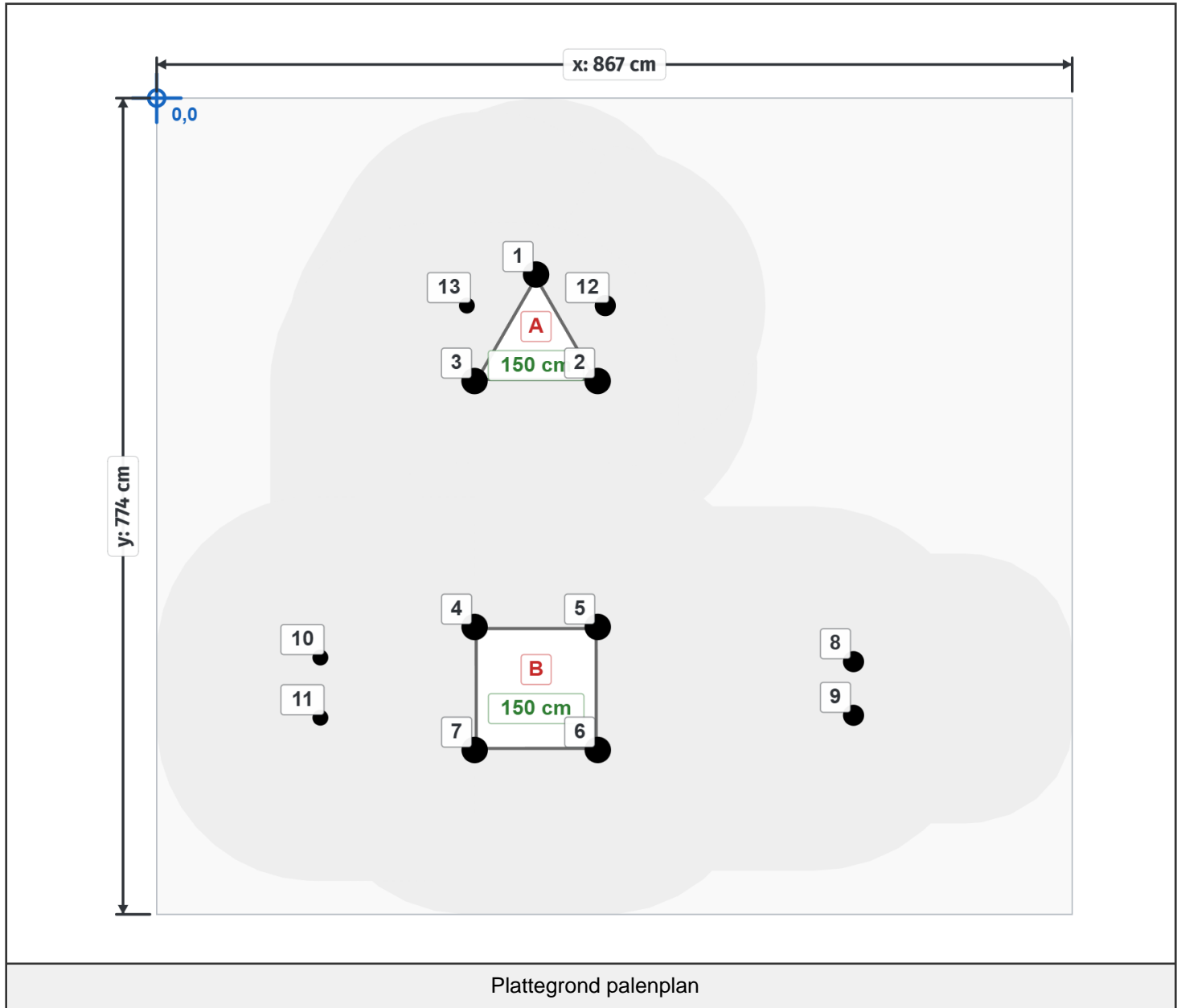

Paalmaten

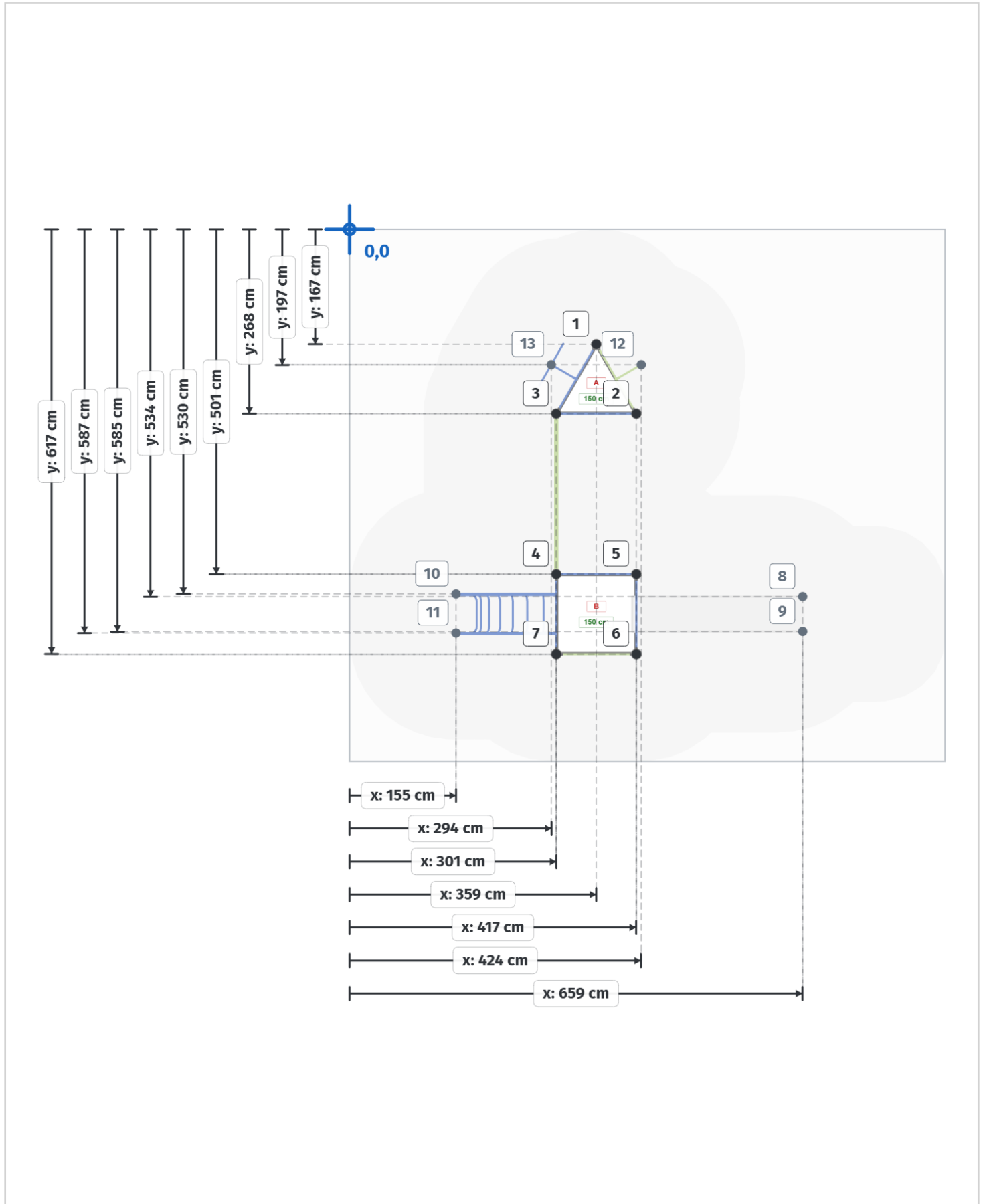

Paaldata

Staanders			
Label	X	Y	Hoogte
1	359 cm	168 cm	350 cm
2	418 cm	268 cm	350 cm
3	301 cm	268 cm	370 cm
4	301 cm	501 cm	370 cm
5	418 cm	501 cm	350 cm
6	418 cm	618 cm	350 cm
7	301 cm	618 cm	350 cm
8	660 cm	534 cm	0 cm
9	660 cm	585 cm	0 cm
10	155 cm	530 cm	0 cm
11	155 cm	587 cm	0 cm
12	425 cm	197 cm	0 cm
13	294 cm	197 cm	0 cm

Vloeren	
Label	Hoogte
A	150 cm
B	150 cm

Onderdeel handleidingen

Op de volgende pagina's van dit document vindt u alle individuele onderdelen met bijbehorende technische tekeningen en eventuele montage instructies.

Staander 370cm

Hoofdafmetingen: 370x11,5cm

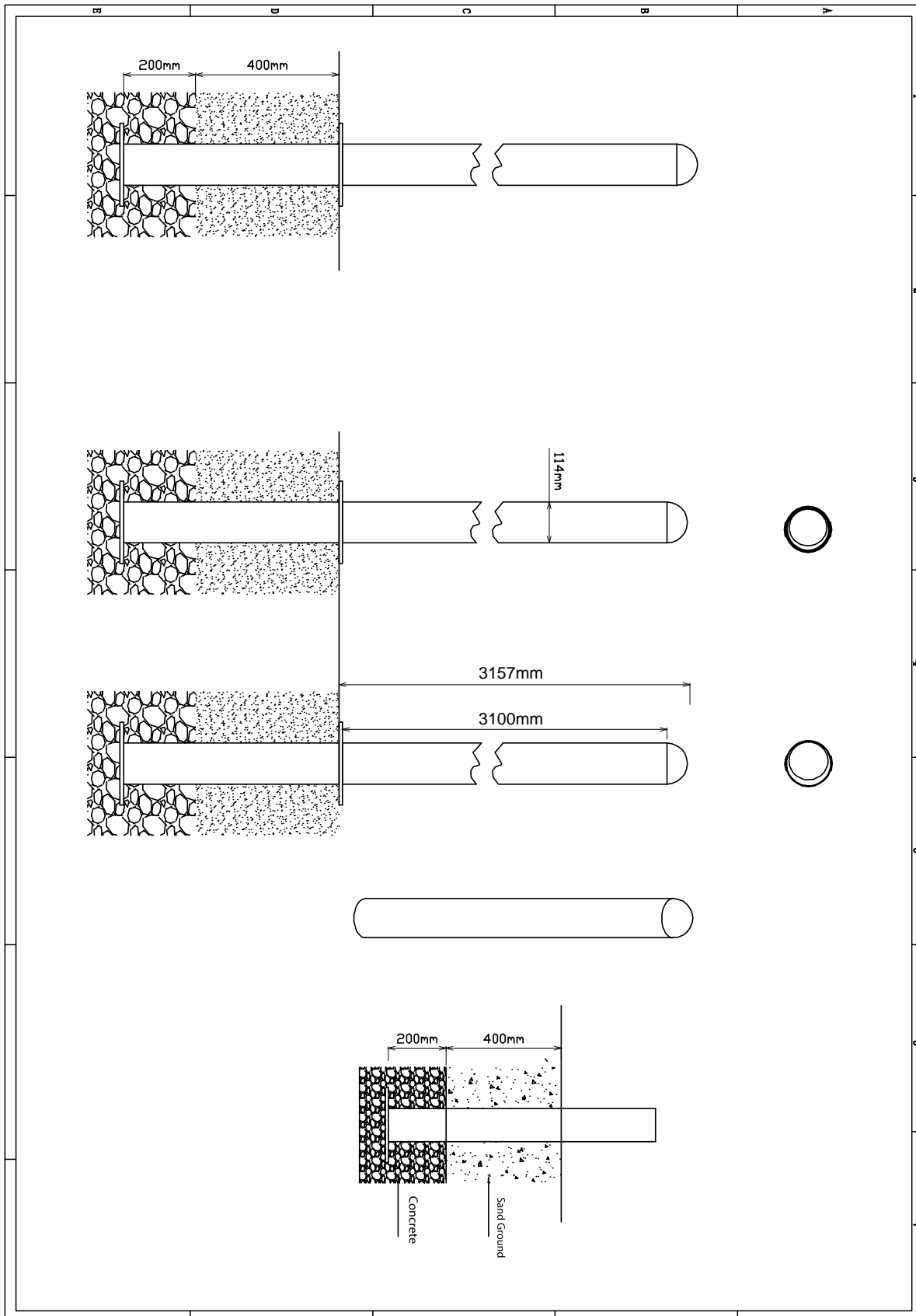

Staander

STAP 1 van 1

Omschrijving: Paalkap losdraaien en opnieuw bevestigen met loctite op het draadeind

1 st. Loctite

1

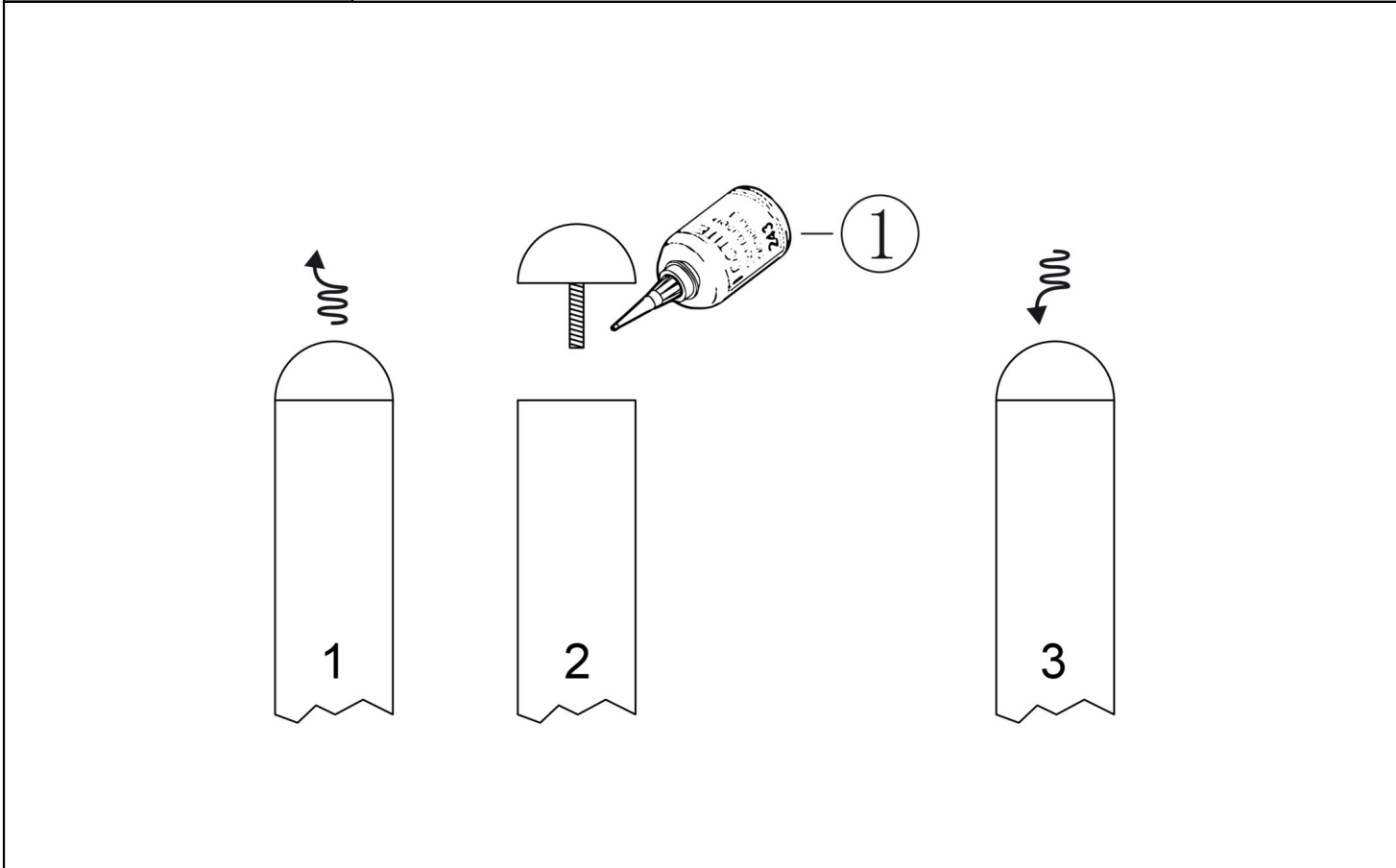

Bevestigings materiaal is per zakje verpakt en bovenstaande afbeelding zit in het zakje

Staander 350cm

Hoofdafmetingen: 350x11,5cm

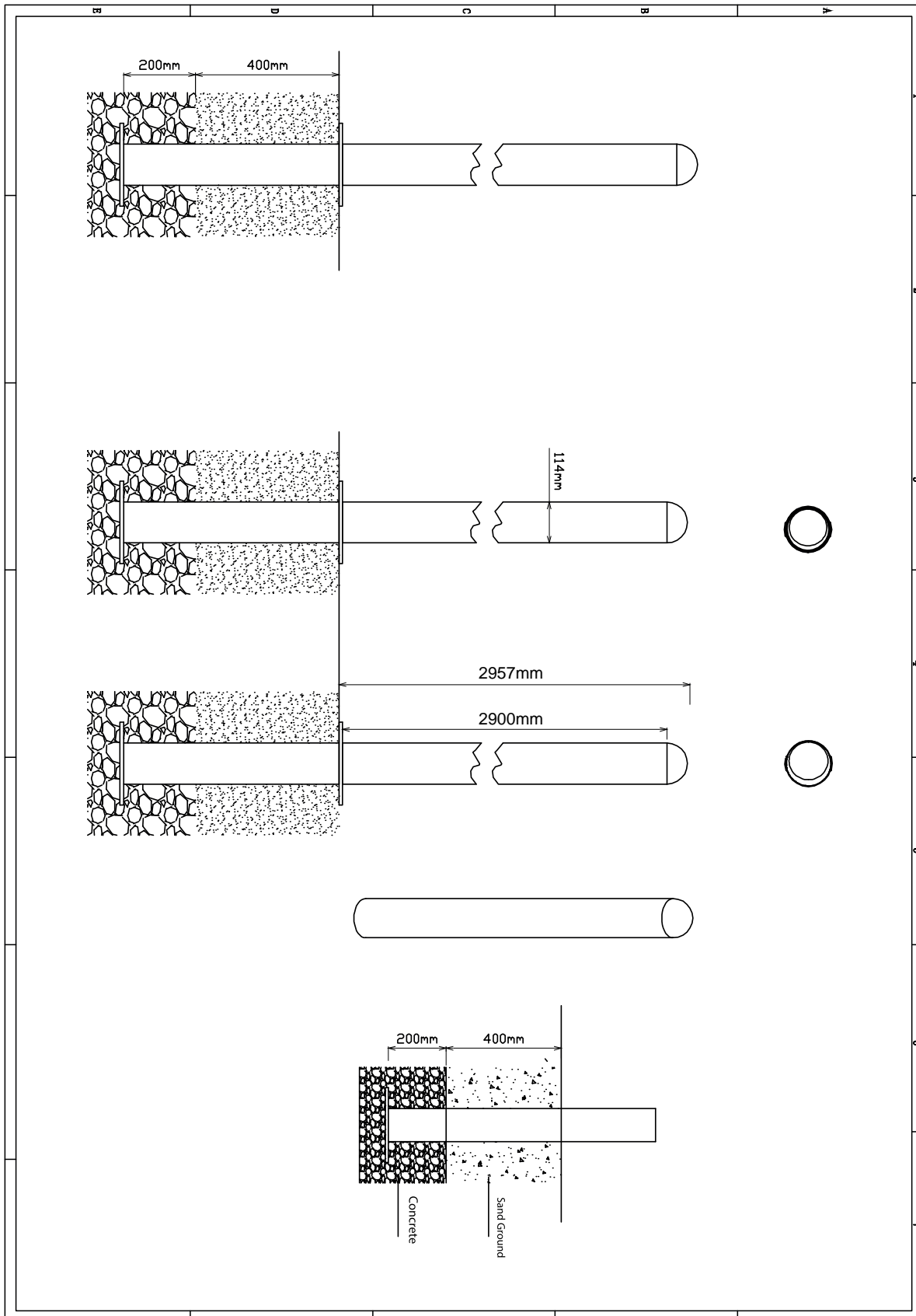

Staander

STAP 1 van 1

Omschrijving: Paalkap losdraaien en opnieuw bevestigen met loctite op het draadeind

1 st. Loctite

1 

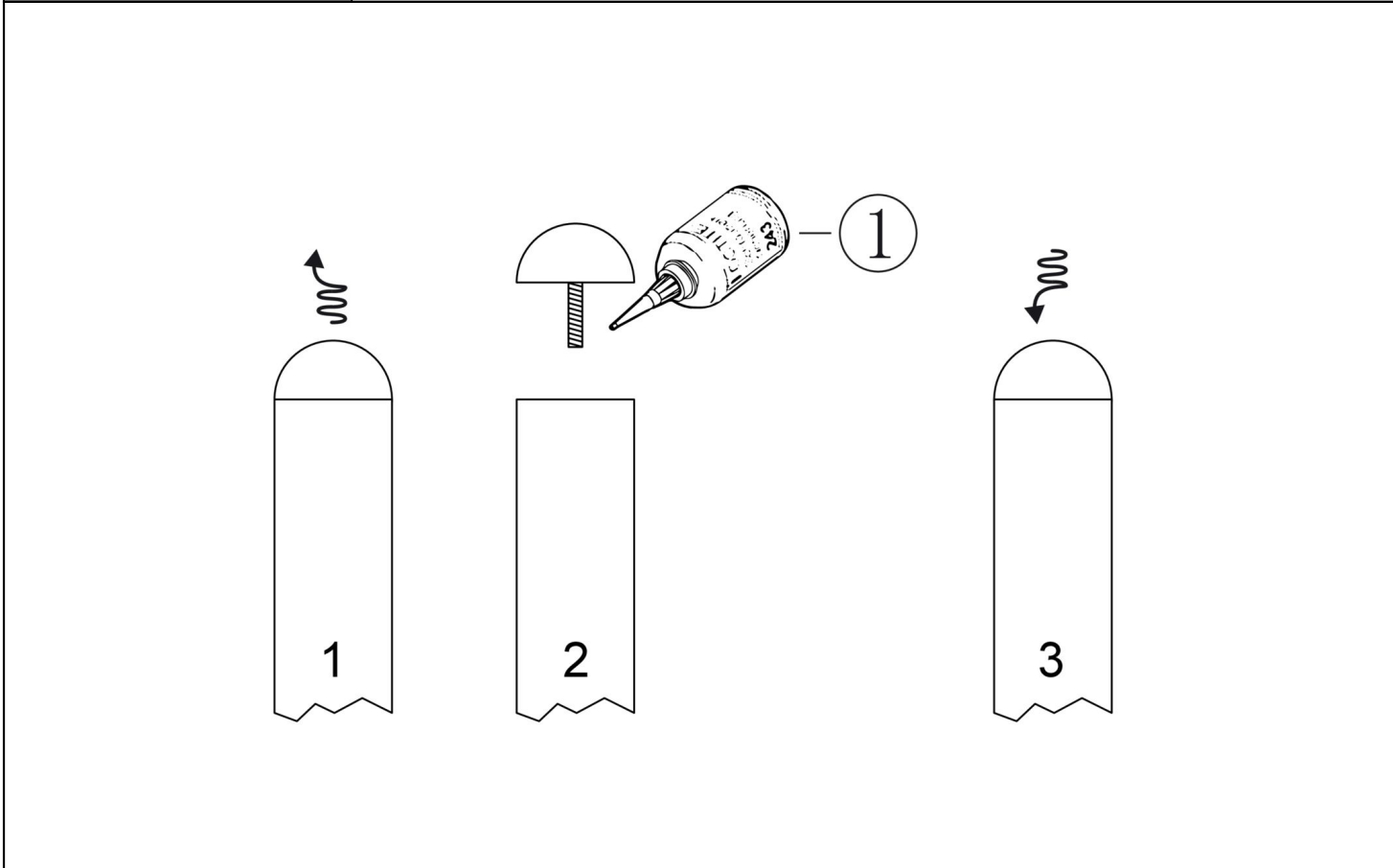

Bevestigings materiaal is per zakje verpakt en bovenstaande afbeelding zit in het zakje

Vloer gelijke driehoek HPL

Hoofdafmetingen: 116,5x1165,5x8,5cm

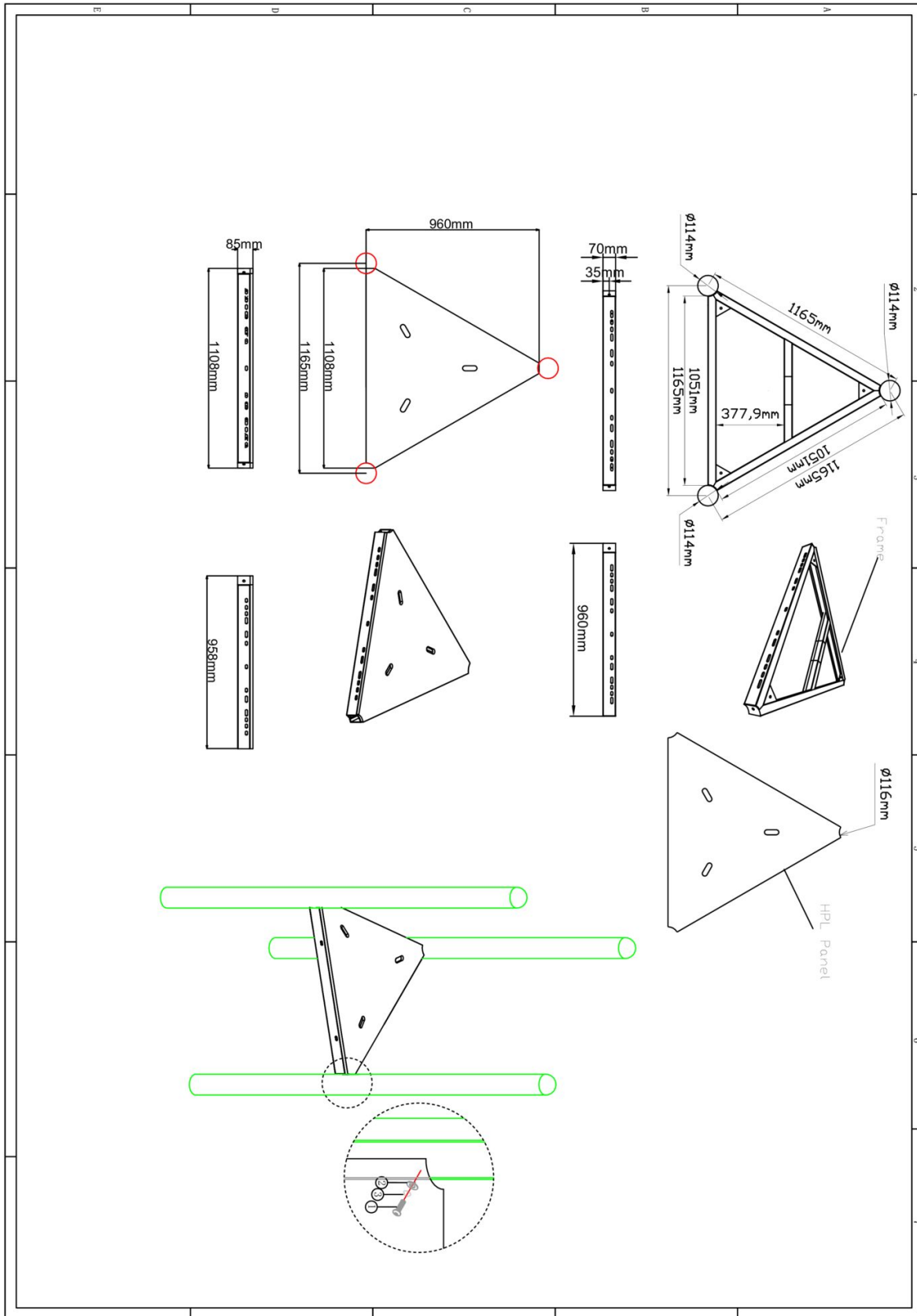

Vloer gelijke driehoek HPL

STAP 1 van 1

Omschrijving: Bevestiging van de vloer aan de staander. In de staander zitten al voor gemonteerde M10 busen op de juiste hoogte waar de bout ingedraaid dienen te worden.

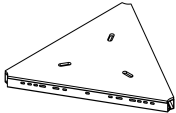
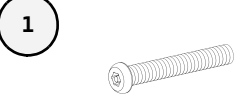
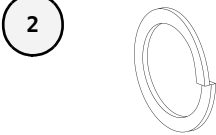
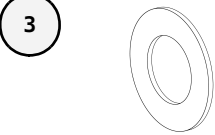
1 st. Vloer gelijke driehoek HPL	3 st. Torx M10X30	3 st. Veerring M10	3 st. Ring M10 (middel)
			

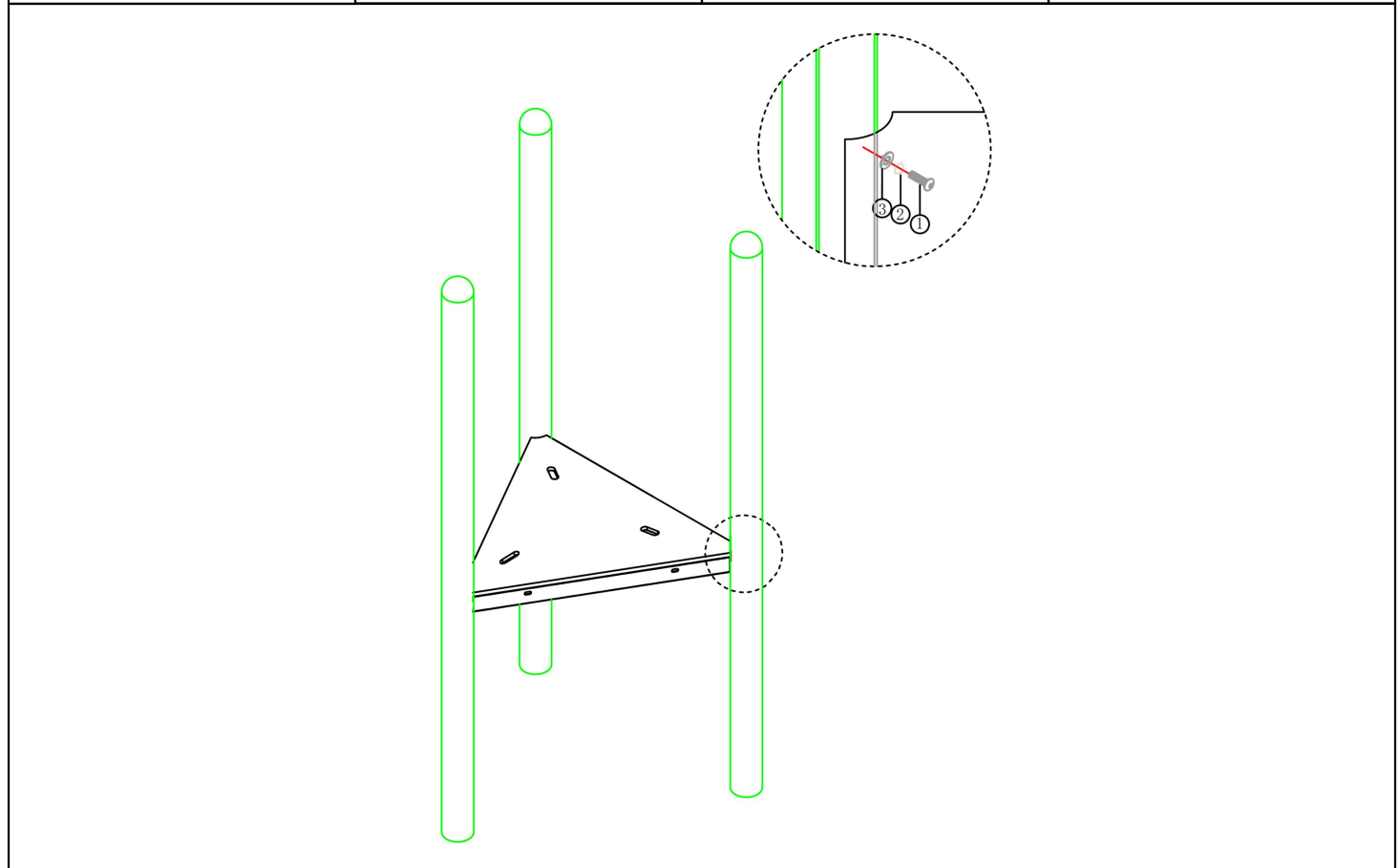

Bevestigings materiaal is per zakje verpakt en bovenstaande afbeelding zit in het zakje

Vloer vierkant HPL

Hoofdafmetingen: 117x117x8,5cm

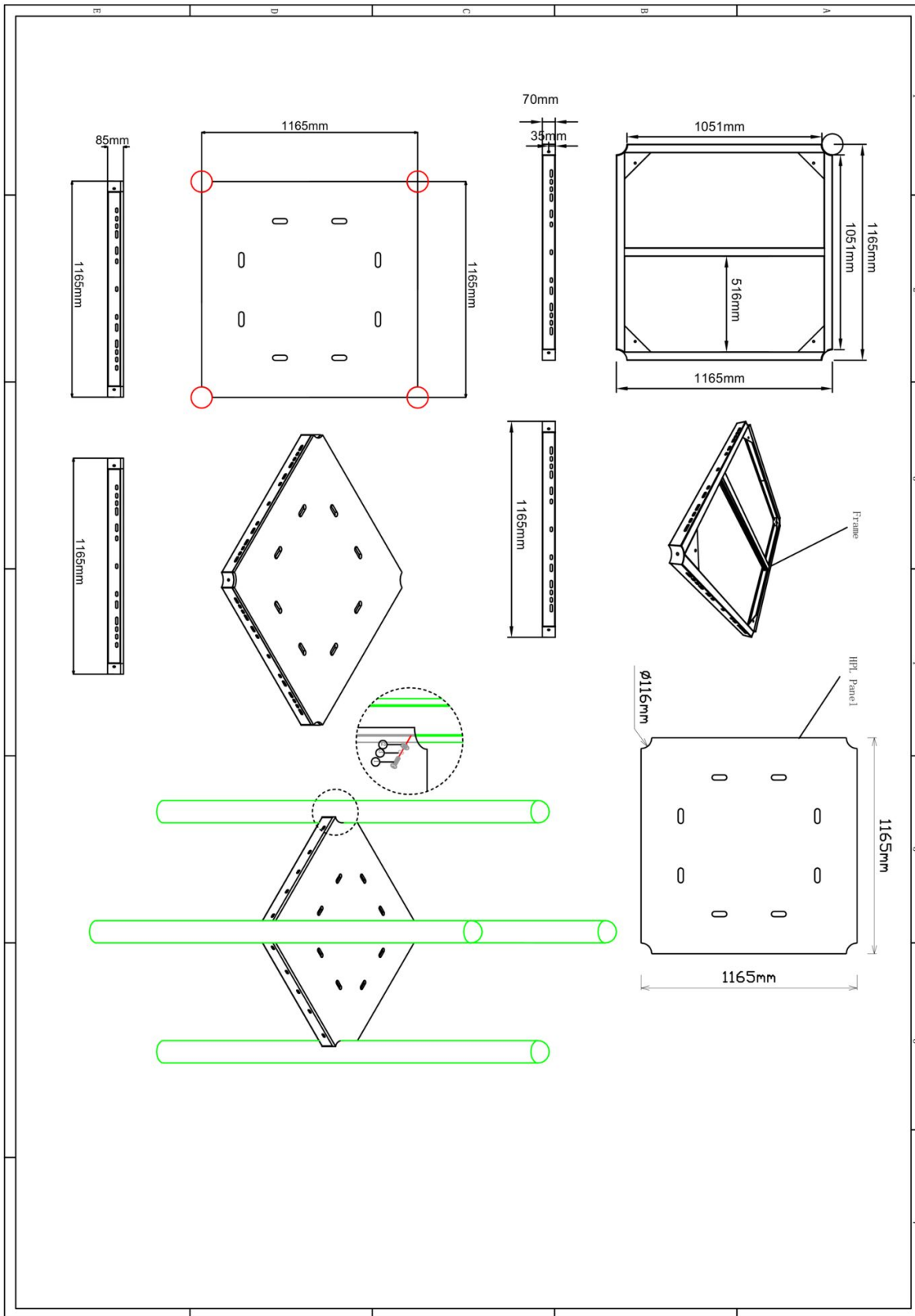

Vloer vierkant HPL

STAP 1 van 1

Omschrijving: Bevestiging van de vloer aan de staander. In de staander zitten al voor gemonteerde M10 bussen op de juiste hoogte waar de bout ingedraaid dienen te worden.

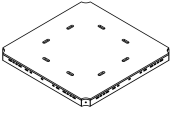
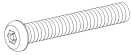
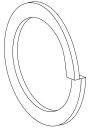
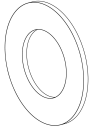
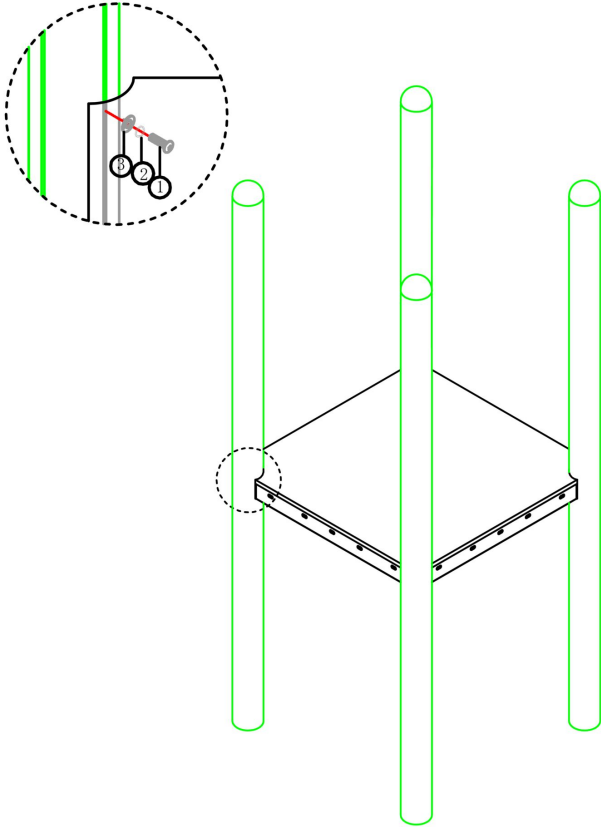
1 st. Vloer vierkant HPL	4 st. Torx M10X30	4 st. Veerring M10	4 st. Ring M10 (middel)
	<p>1</p> 	<p>2</p> 	<p>3</p> 
			
<p>Bevestigings materiaal is per zakje verpakt en bovenstaande afbeelding zit in het zakje</p>			

Klimnet 233cm

Hoofdafmetingen: 218x200cm

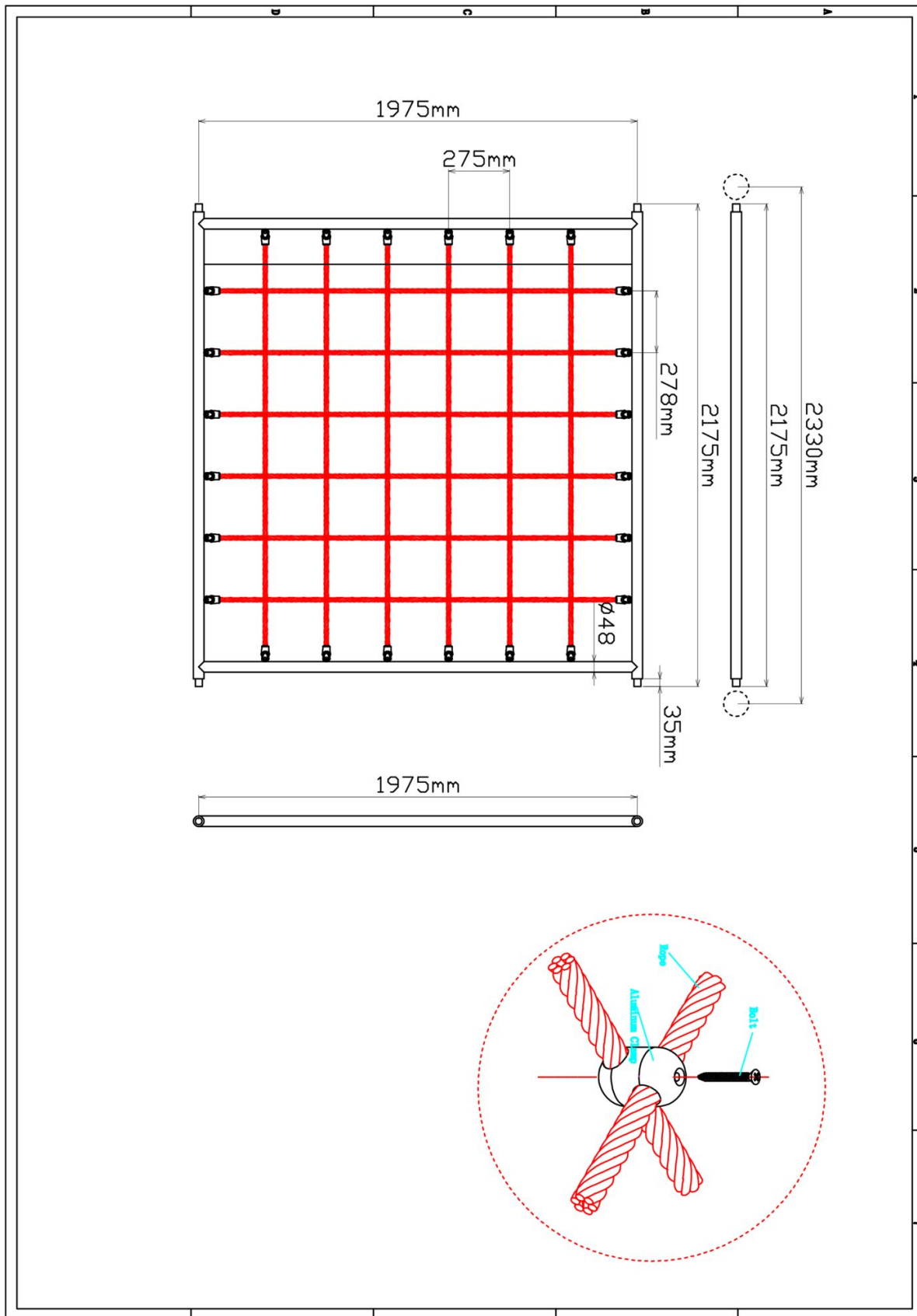

Klimnet 233cm

STAP 1 van 3

Omschrijving: Zelftap bouten aanbrengen aan de binnenkant van de palen (*bij een vloer van 150cm komt de zelftap bout op 60cm en bij een vloer van 120cm komt de zelftap bout op 90cm vanaf de vloer)

2 st. Zeskant M3X16
Zelftap

1

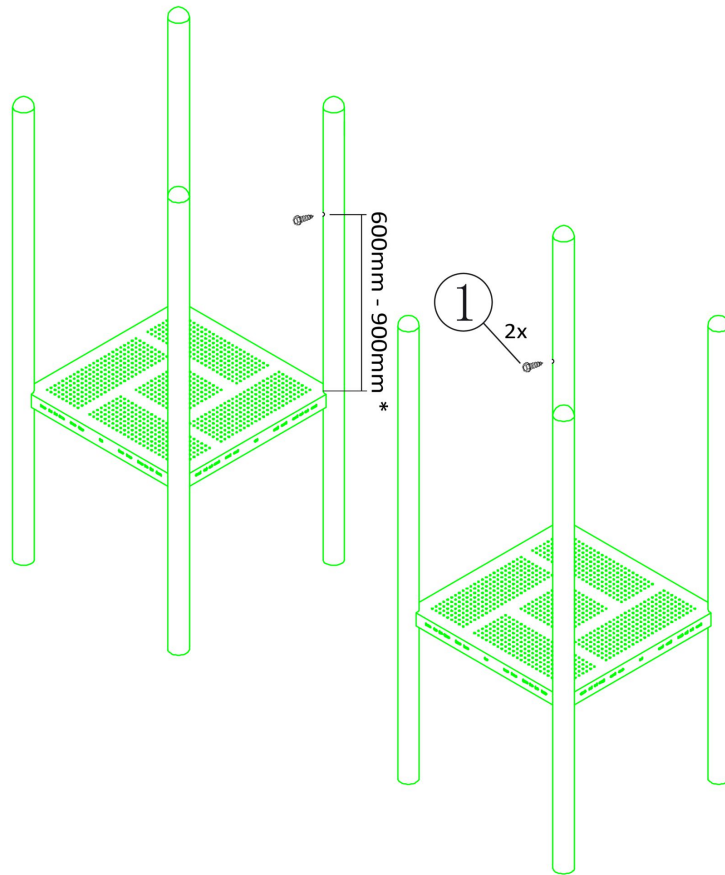

Bevestigings materiaal is per zakje verpakt en bovenstaande afbeelding zit in het zakje

Klimnet 233cm

STAP 2 van 3

Omschrijving: Koppelingsring over de schroef schuiven en vastzetten zodat de schroef niet meer zichtbaar is en de ring door de schroef niet kan zakken op de paal

2 st. Small clamp + ring

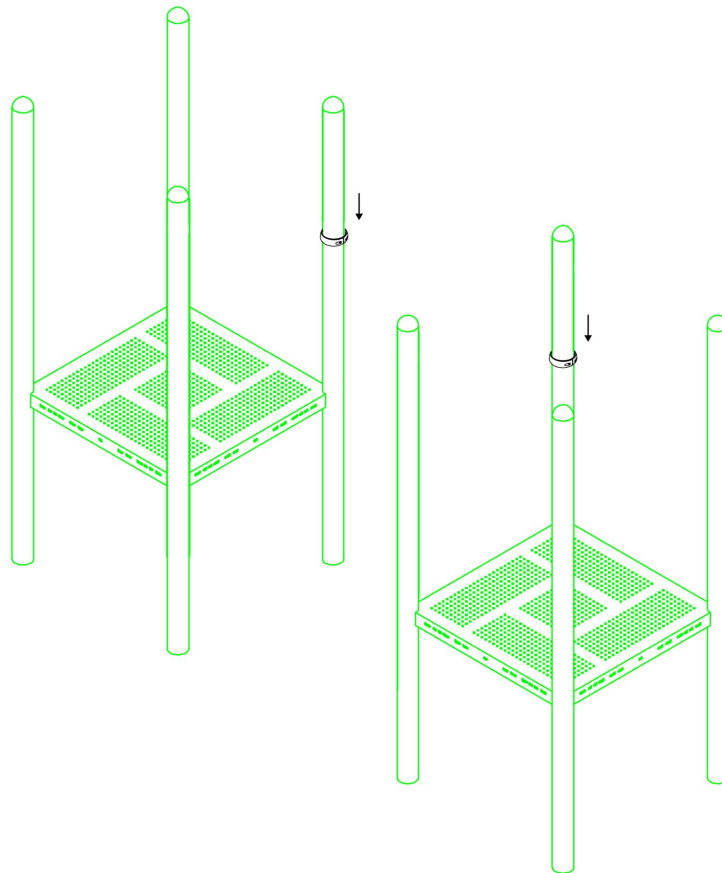





Bevestigings materiaal is per zakje verpakt en bovenstaande afbeelding zit in het zakje

Klimnet 233cm

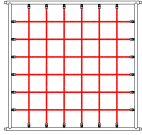
STAP 3 van 3

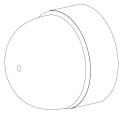
Omschrijving: Bevestiging het klimnet eerst aan de bovenste ring welke al aan de staander zit en bevestig daarna de onderste ring aan het klimnet en de staander

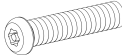
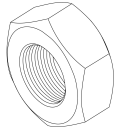
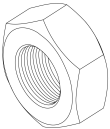
1 st. Klimnet 233cm	2 st. Small clamp + ring		
			
24 st. Afdekdop M10	4 st. Kruiskop M6X65	8 st. Torx M8X20	8 st. Lock Moer M8
	① 	② 	③ 
4 st. Lock Moer M6			
④ 			

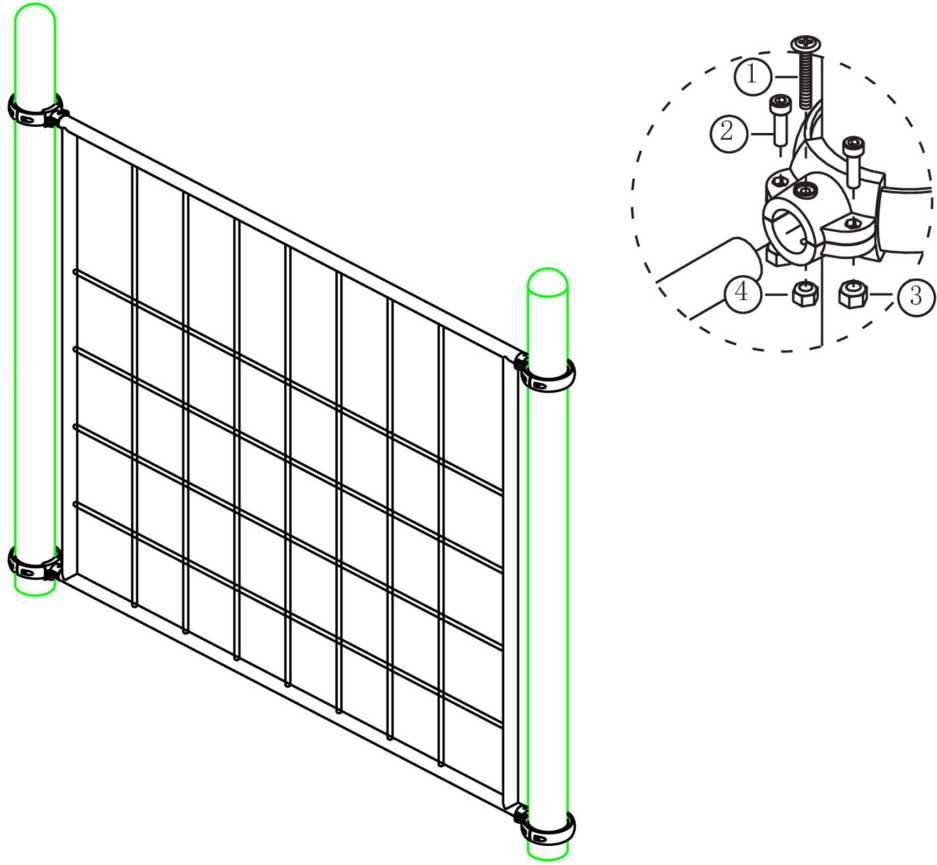

Bevestigings materiaal is per zakje verpakt en bovenstaande afbeelding zit in het zakje

Hek voor klimnet metaal



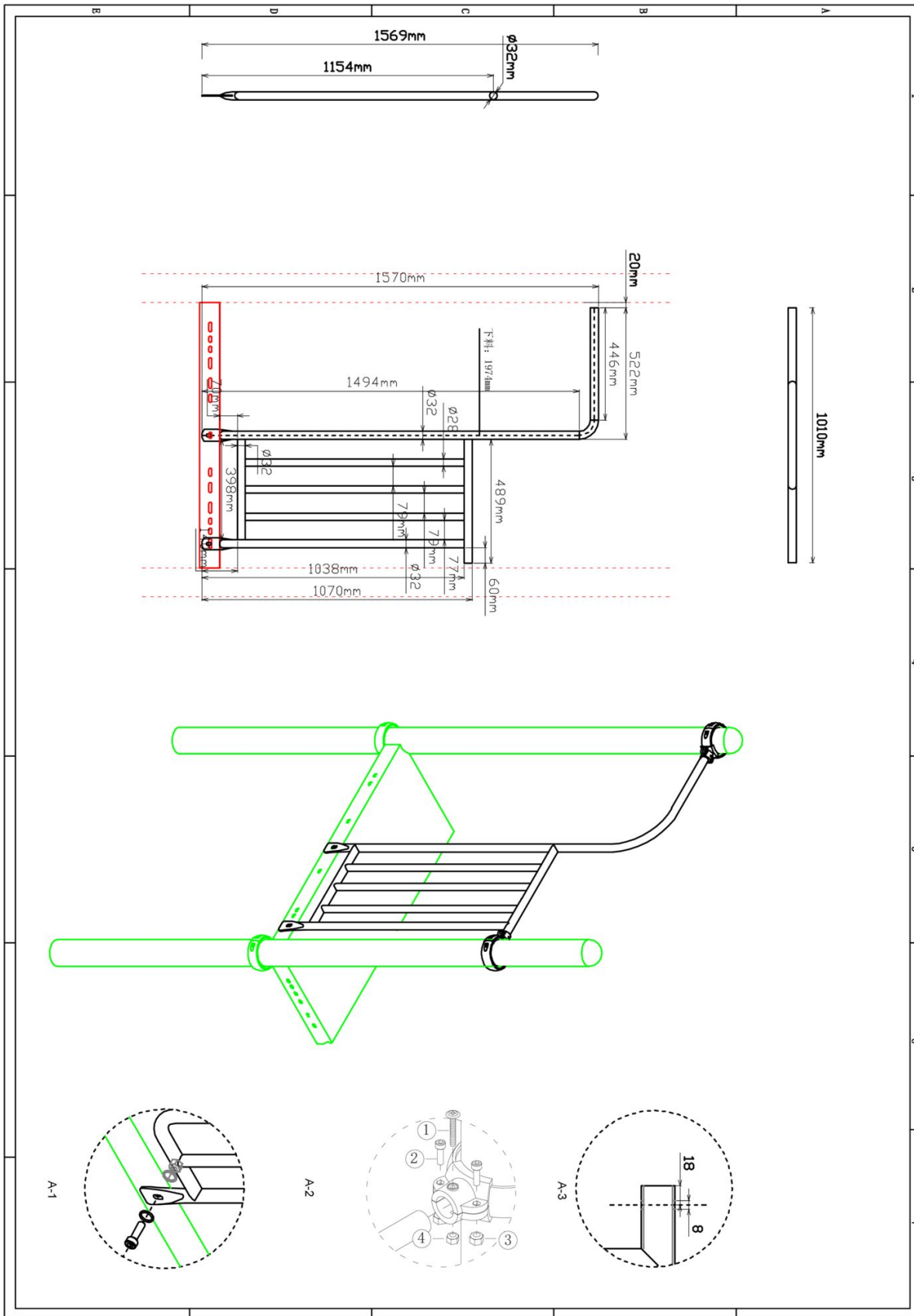

Hoofdafmetingen: 157x53cm

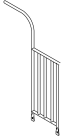

Hek voor klimnet metaal

STAP 1 van 1

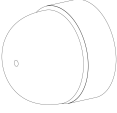
Omschrijving: Bevestiging tussen de vloer/staander

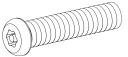
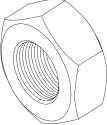
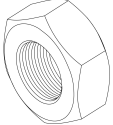
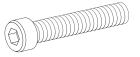
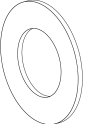
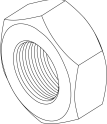
1 st. Hek voor klimnet metaal	4 st. Small clamp + ring	2 st. Afdekdop M10	4 st. Kruiskop M6X65
			① 
8 st. Torx M8X20	8 st. Lock Moer M8	4 st. Lock Moer M6	2 st. Bout M10X25
② 	③ 	④ 	⑤ 
4 st. Ring M10 (middel)	2 st. Lock Moer M10		
⑥ 	⑦ 		

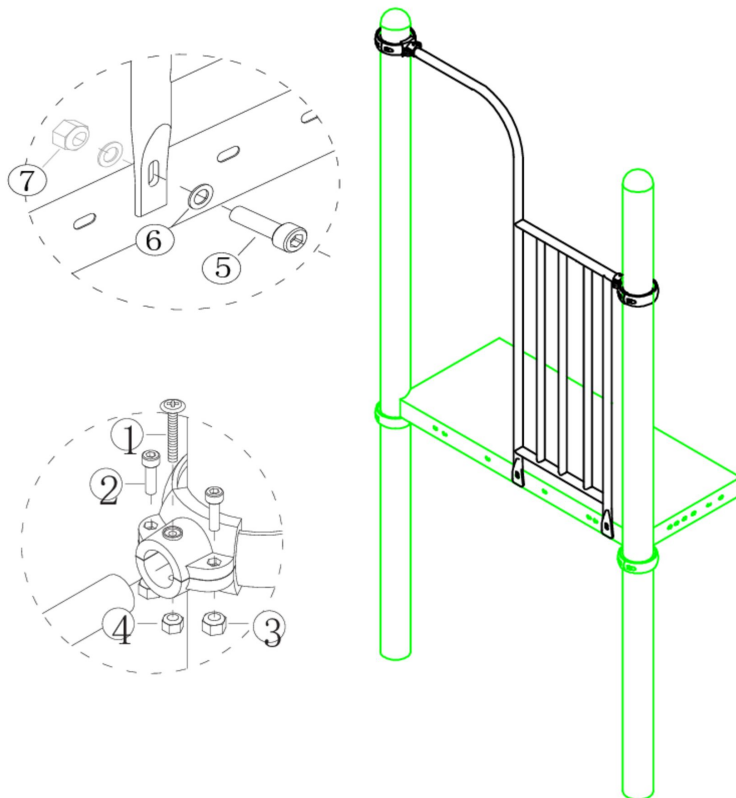

Bevestigings materiaal is per zakje verpakt en bovenstaande afbeelding zit in het zakje

Stangenopgang 150cm

Hoofdafmetingen: 3,2x101 (stang 3x)

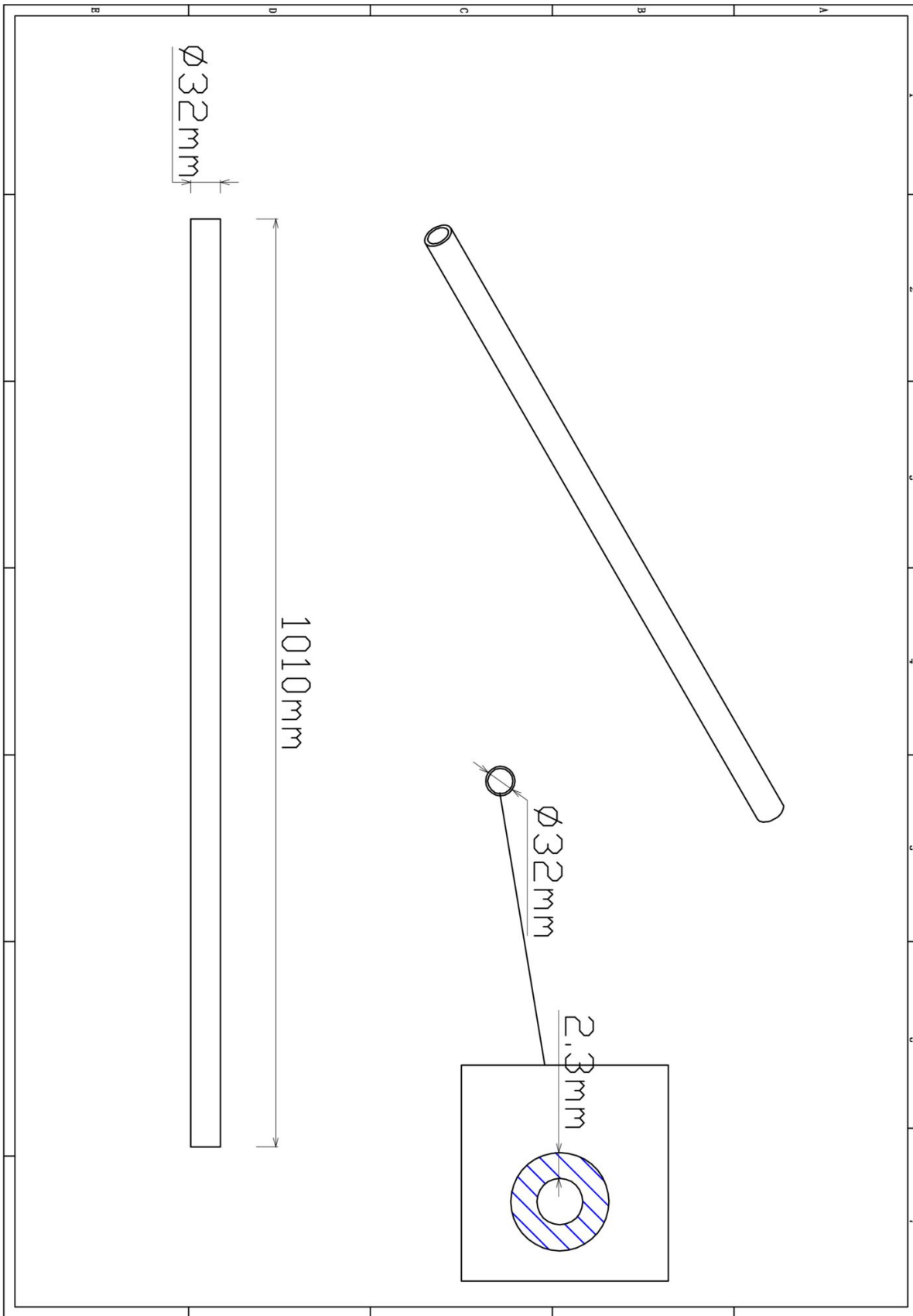

Stangenopgang 150cm

STAP 1 van 3

Omschrijving: Zelftap bouten aanbrengen aan de binnenkant van de palen

6 st. Zeskant M3X16
Zelftap

1

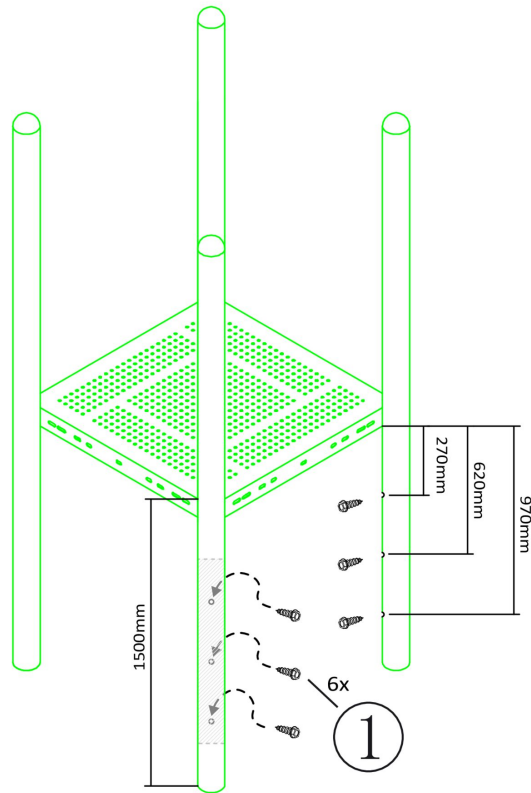

Bevestigings materiaal is per zakje verpakt en bovenstaande afbeelding zit in het zakje

Stangenopgang 150cm

STAP 2 van 3

Omschrijving: Koppelingsring over de schroef schuiven en vastzetten zodat de schroef niet meer zichtbaar is en de ring door de schroef niet kan zakken op de paal

6 st. Small clamp + ring

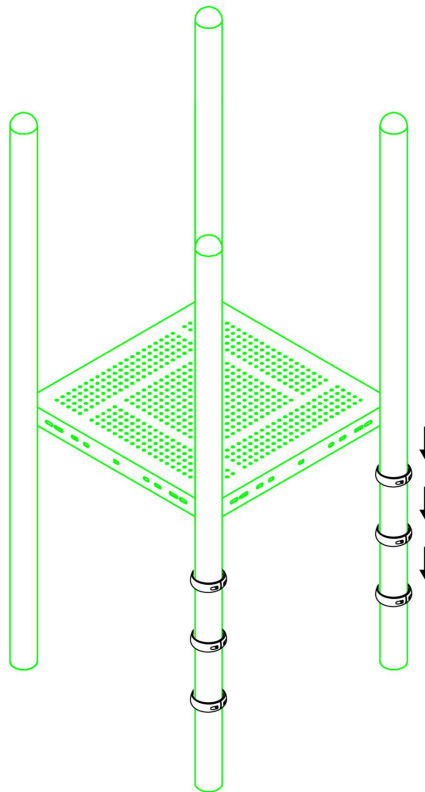

Bevestigings materiaal is per zakje verpakt en bovenstaande afbeelding zit in het zakje

Stangenopgang 150cm

STAP 3 van 3

Omschrijving: Stang vastzetten met behulp van de klemmen

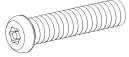
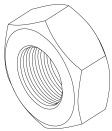
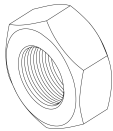
6 st. Kruiskop M6X65	12 st. Torx M8X20
1 	2 
12 st. Lock Moer M8	6 st. Lock Moer M6
3 	4 

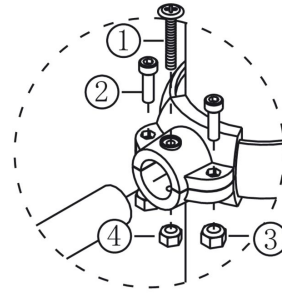
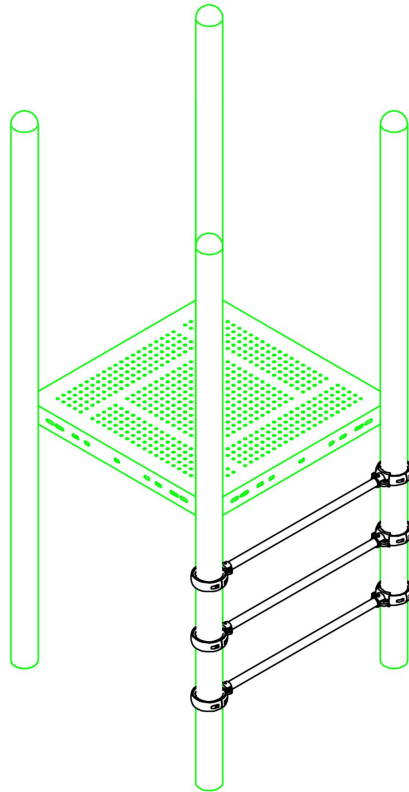





Bevestigings materiaal is per zakje verpakt en bovenstaande afbeelding zit in het zakje

Hekje tbv: B, Pod en Curly Climber

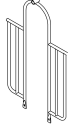
STAP 1 van 1

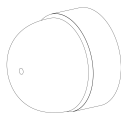
Omschrijving: Bevestiging van het hek tussen de vloer/staander

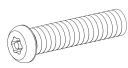
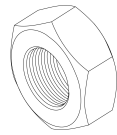
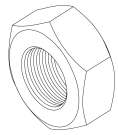
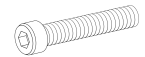
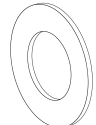
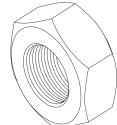
1 st. Hekje tbv: B, Pod en Curly Climber	2 st. Small clamp + ring	2 st. Afdekdop M10	2 st. Kruiskop M6X65
			① 
4 st. Torx M8X20	4 st. Lock Moer M8	2 st. Lock Moer M6	2 st. Bout M10X25
② 	③ 	④ 	⑤ 
4 st. Ring M10 (middel)	2 st. Lock Moer M10		
⑥ 	⑦ 		

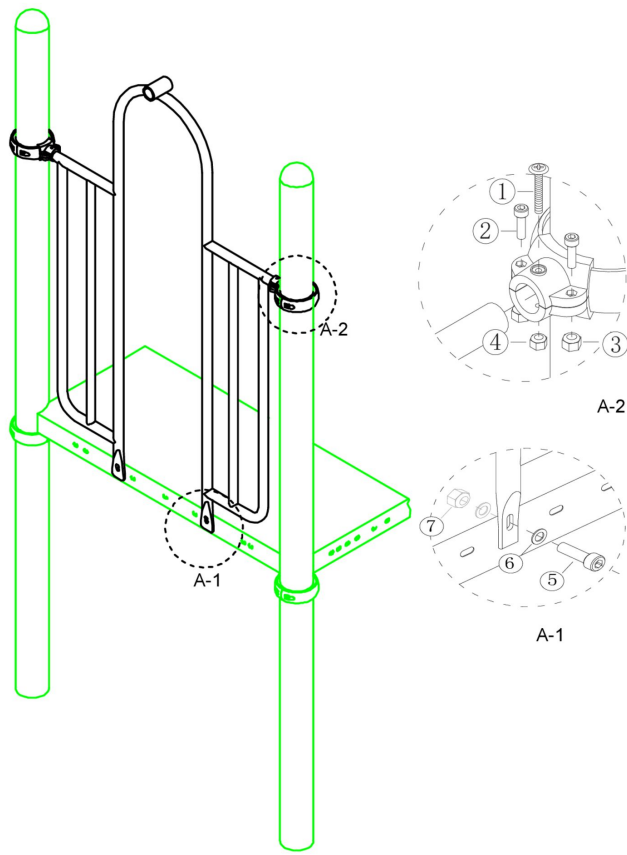

Bevestigings materiaal is per zakje verpakt en bovenstaande afbeelding zit in het zakje

150cm B climber

Hoofdafmetingen: 362x44cm

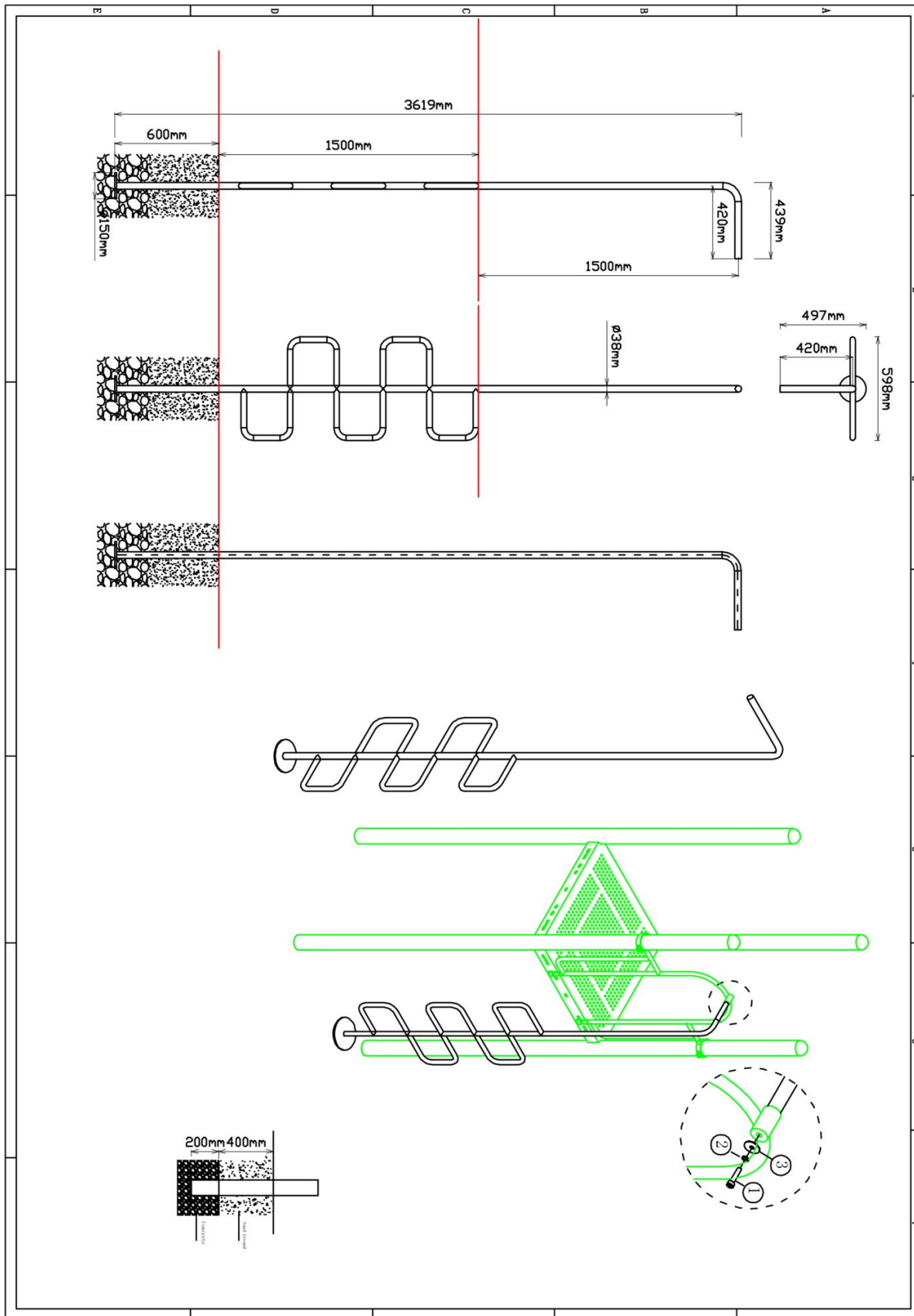

150cm B climber

STAP 1 van 1

Omschrijving: Bevestiging tussen B-climber en hek

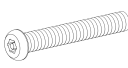
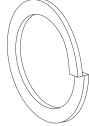
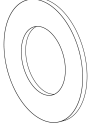
1 st. 150cm B climber	1 st. Torx M10X30	1 st. Veerring M10	1 st. Ring M10 (middel)
			

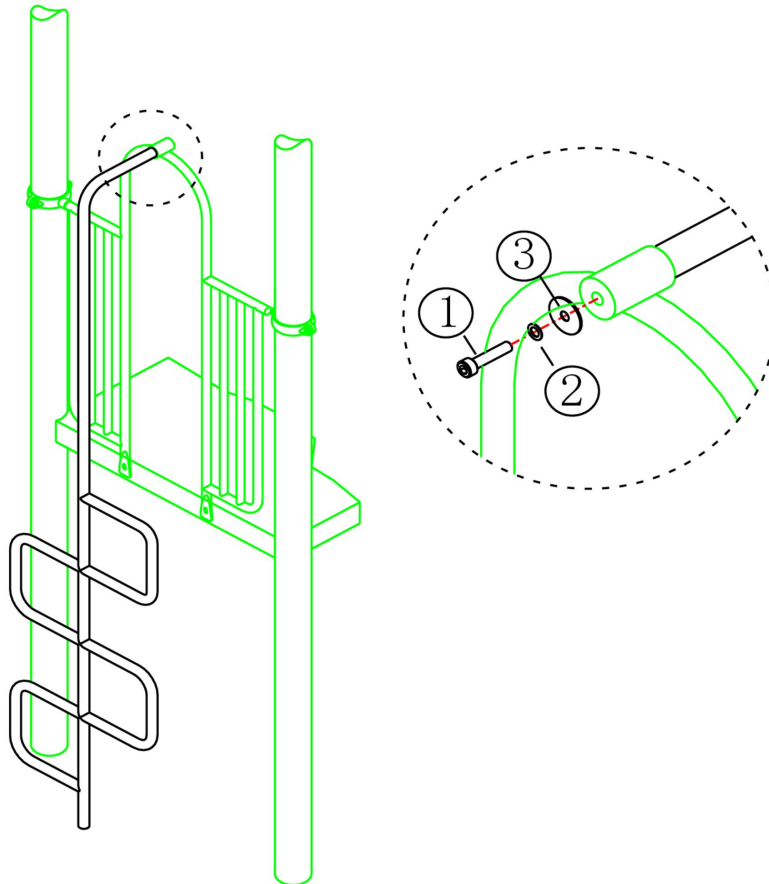

Bevestigings materiaal is per zakje verpakt en bovenstaande afbeelding zit in het zakje

Hekje zonder bevestiging (boven)



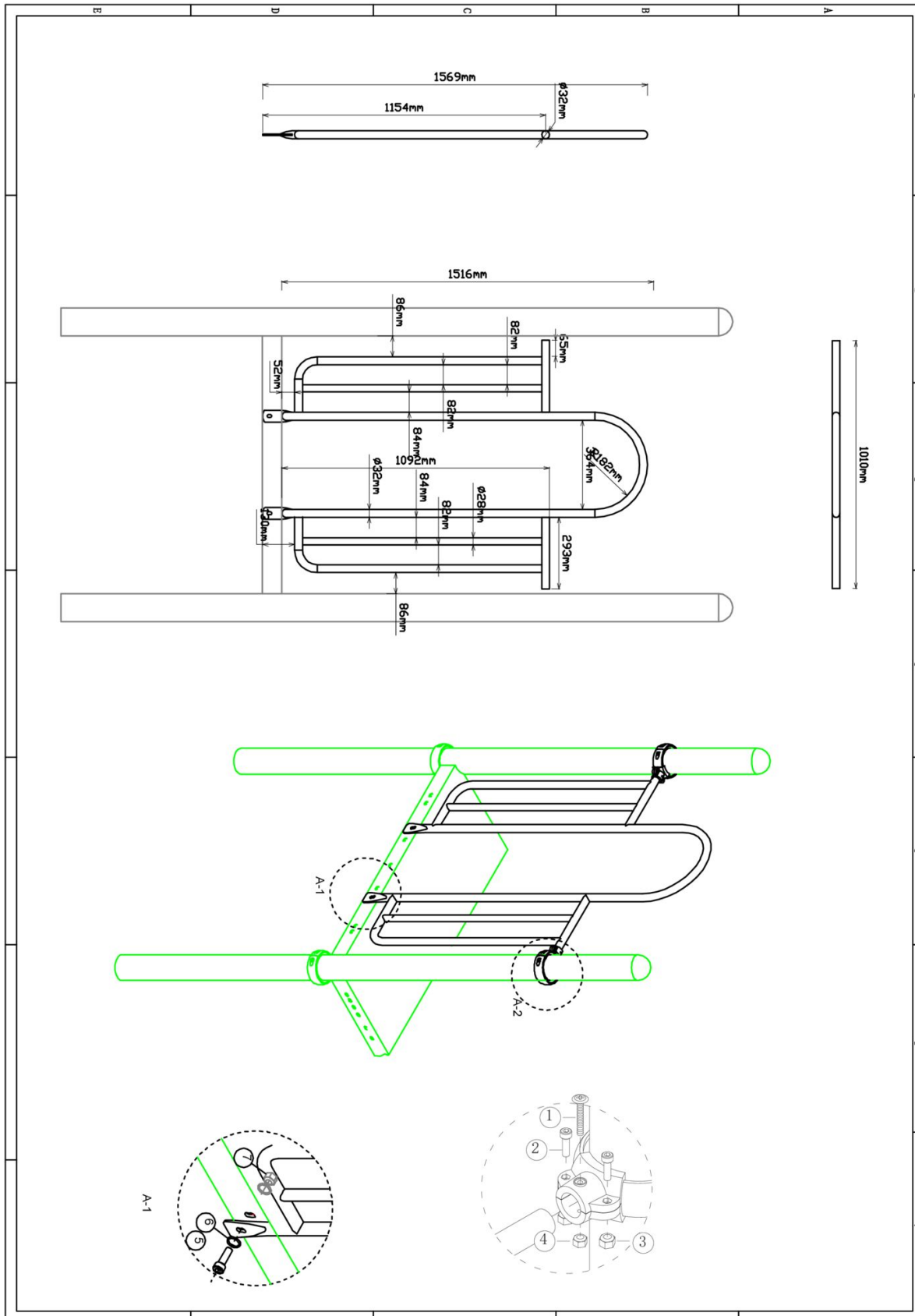

Hoofdafmetingen: 152x101cm

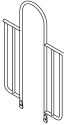

Hekje zonder bevestiging (boven)

STAP 1 van 1

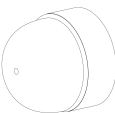
Omschrijving: Bevestiging van het hek tussen de vloer/staander

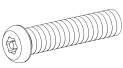
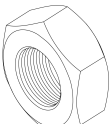
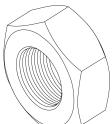
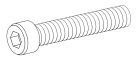
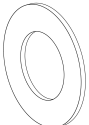
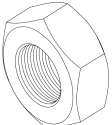
1 st. Hekje zonder bevestiging (boven)	2 st. Small clamp + ring	2 st. Afdekdop M10	2 st. Kruiskop M6X65
			① 
4 st. Torx M8X20	4 st. Lock Moer M8	2 st. Lock Moer M6	2 st. Bout M10X25
② 	③ 	④ 	⑤ 
4 st. Ring M10 (middel)	2 st. Lock Moer M10		
⑥ 	⑦ 		

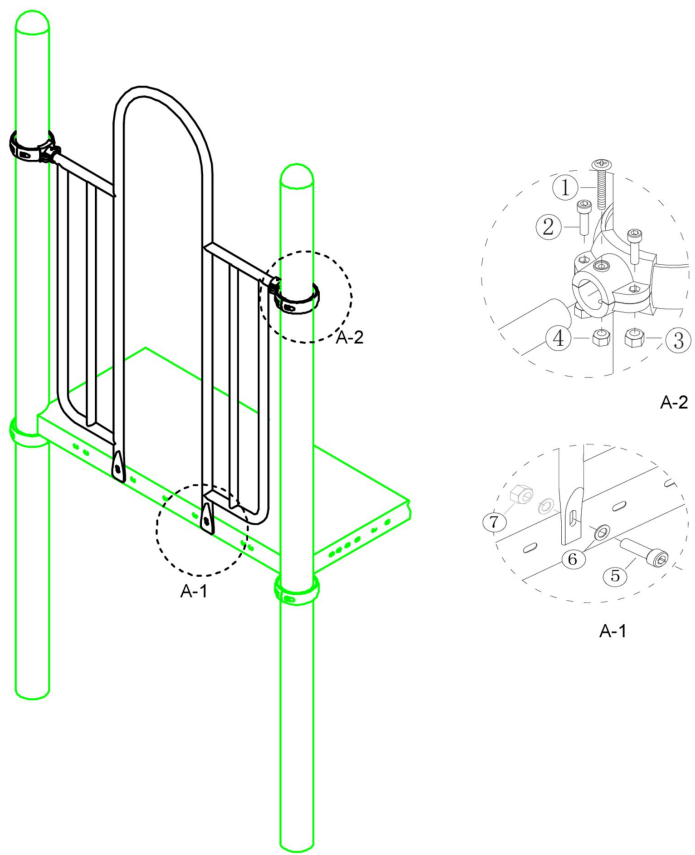

Bevestigings materiaal is per zakje verpakt en bovenstaande afbeelding zit in het zakje

150cm Arch climber

Hoofdafmetingen: 217x150x73cm

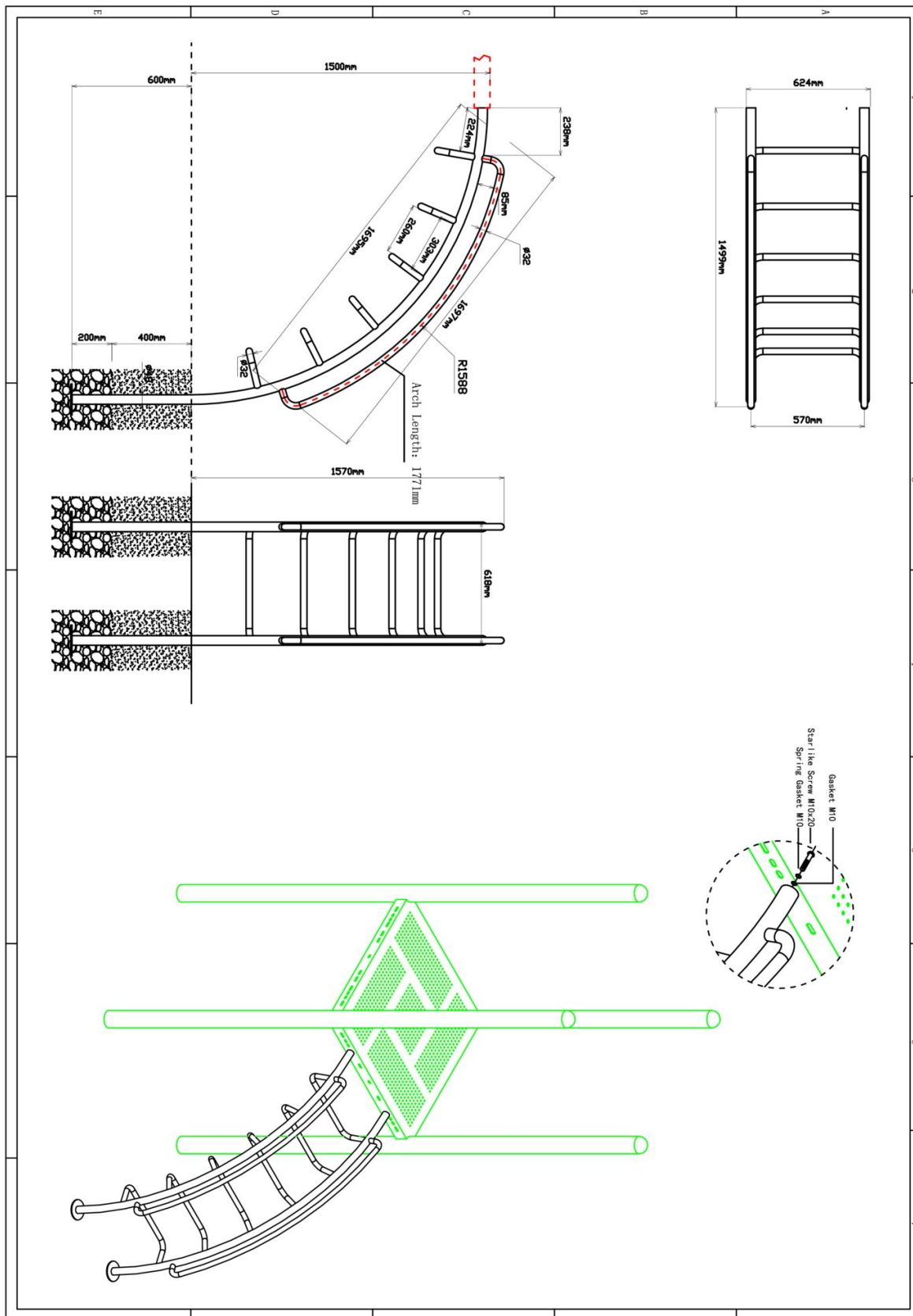

150cm Arch climber

STAP 1 van 1

Omschrijving: Bevestiging tussen vloer en Arch climber

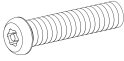
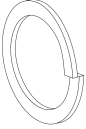
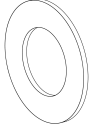
1 st. 150cm Arch climber	2 st. Torx M10X20	2 st. Veerring M10	2 st. Ring M10 (middel)
			

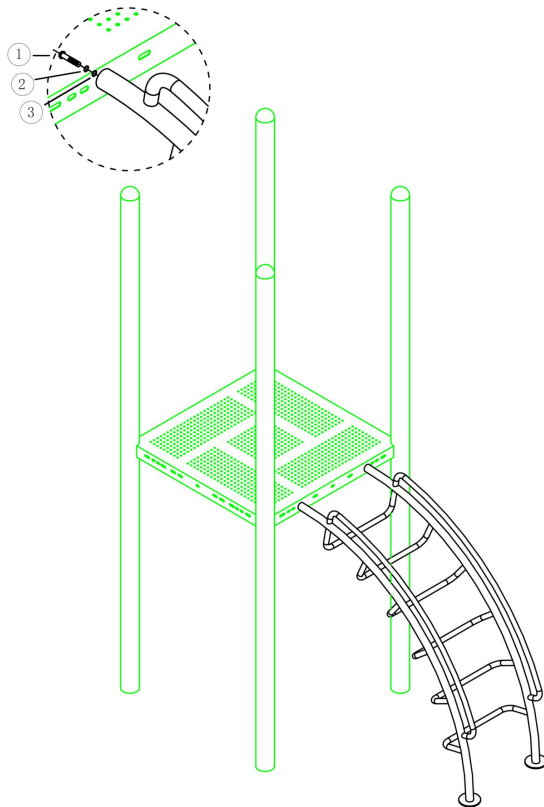

Bevestigings materiaal is per zakje verpakt en bovenstaande afbeelding zit in het zakje

Hekje tbv glijstang



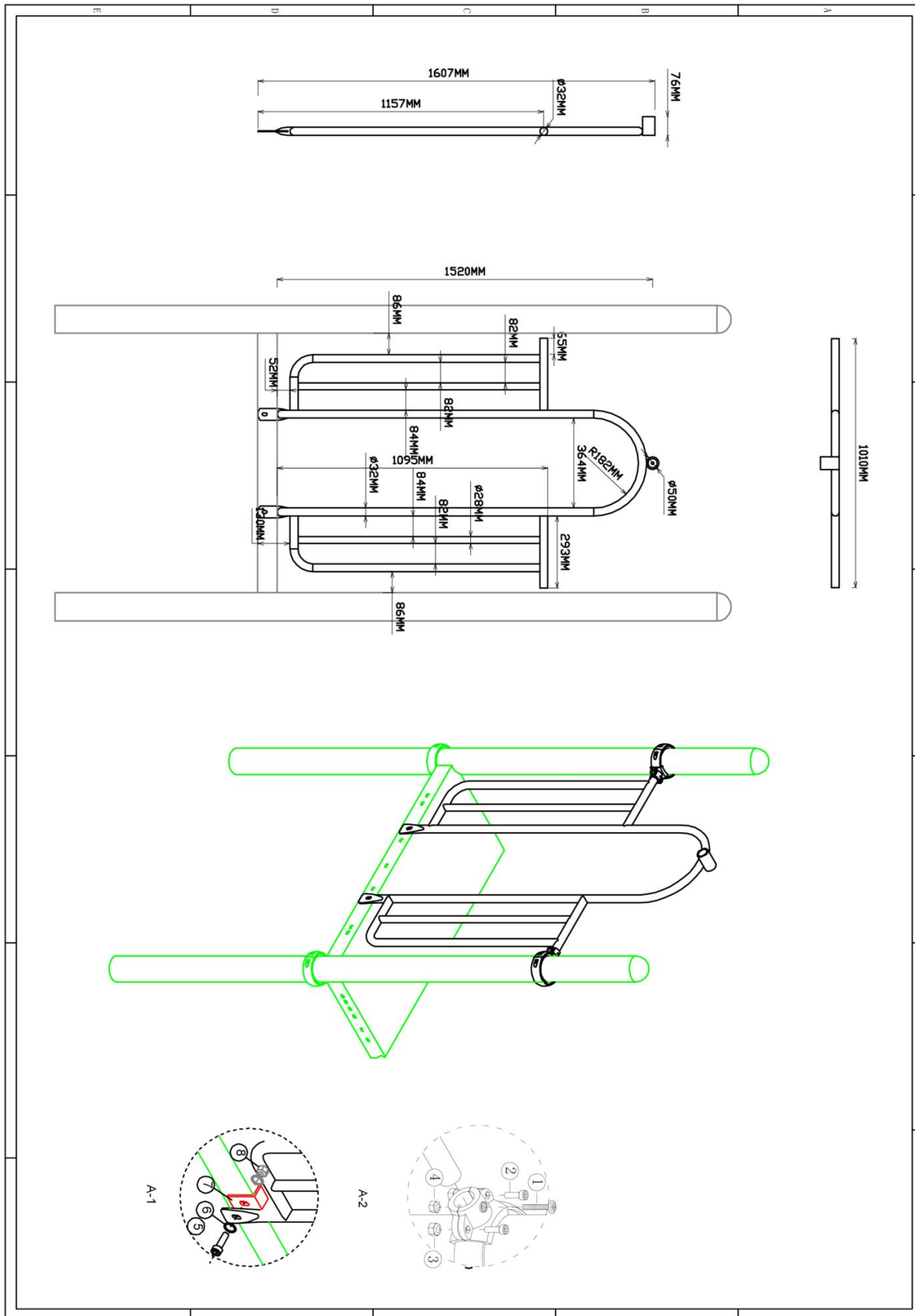





Hoofdafmetingen: 152x101cm

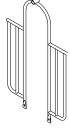

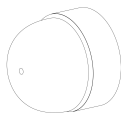
Hekje tbv glijstang

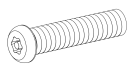
STAP 1 van 1

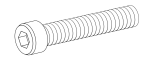
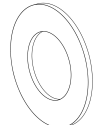
Omschrijving: Bevestiging van het hek tussen de vloer/staander

1 st. Hekje tbv glijstang	2 st. Small clamp + ring	2 st. Afdekdop M10	2 st. Kruiskop M6X65
			
4 st. Torx M8X20	4 st. Lock Moer M8	2 st. Lock Moer M6	2 st. Bout M10X25
			
4 st. Ring M10 (middel)	2 st. Hoekje	2 st. Lock Moer M10	
			

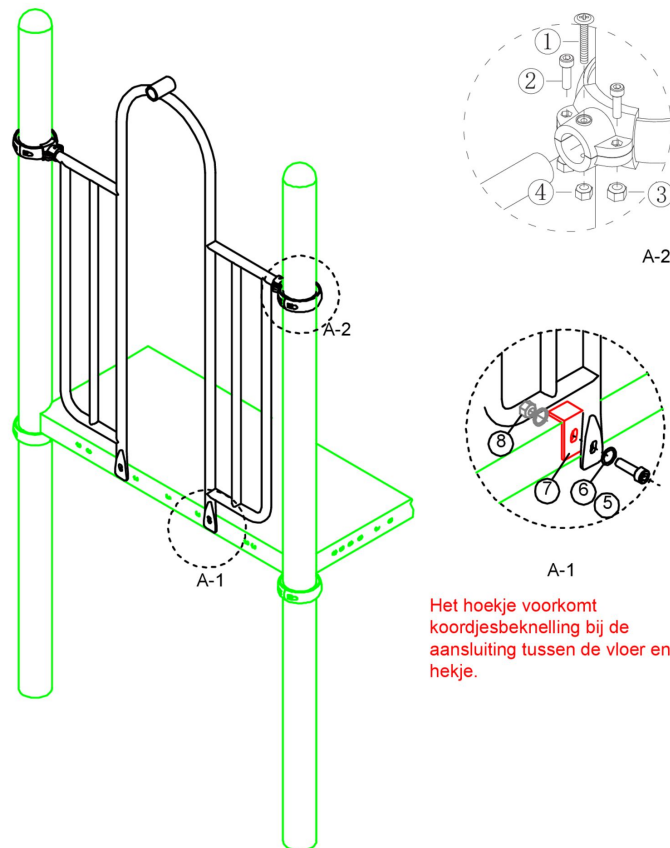

Het hoekje voorkomt koordjesbeknelling bij de aansluiting tussen de vloer en het hekje.

Bevestigings materiaal is per zakje verpakt en bovenstaande afbeelding zit in het zakje

150cm Glijstang

Hoofdafmetingen: 362x42cm

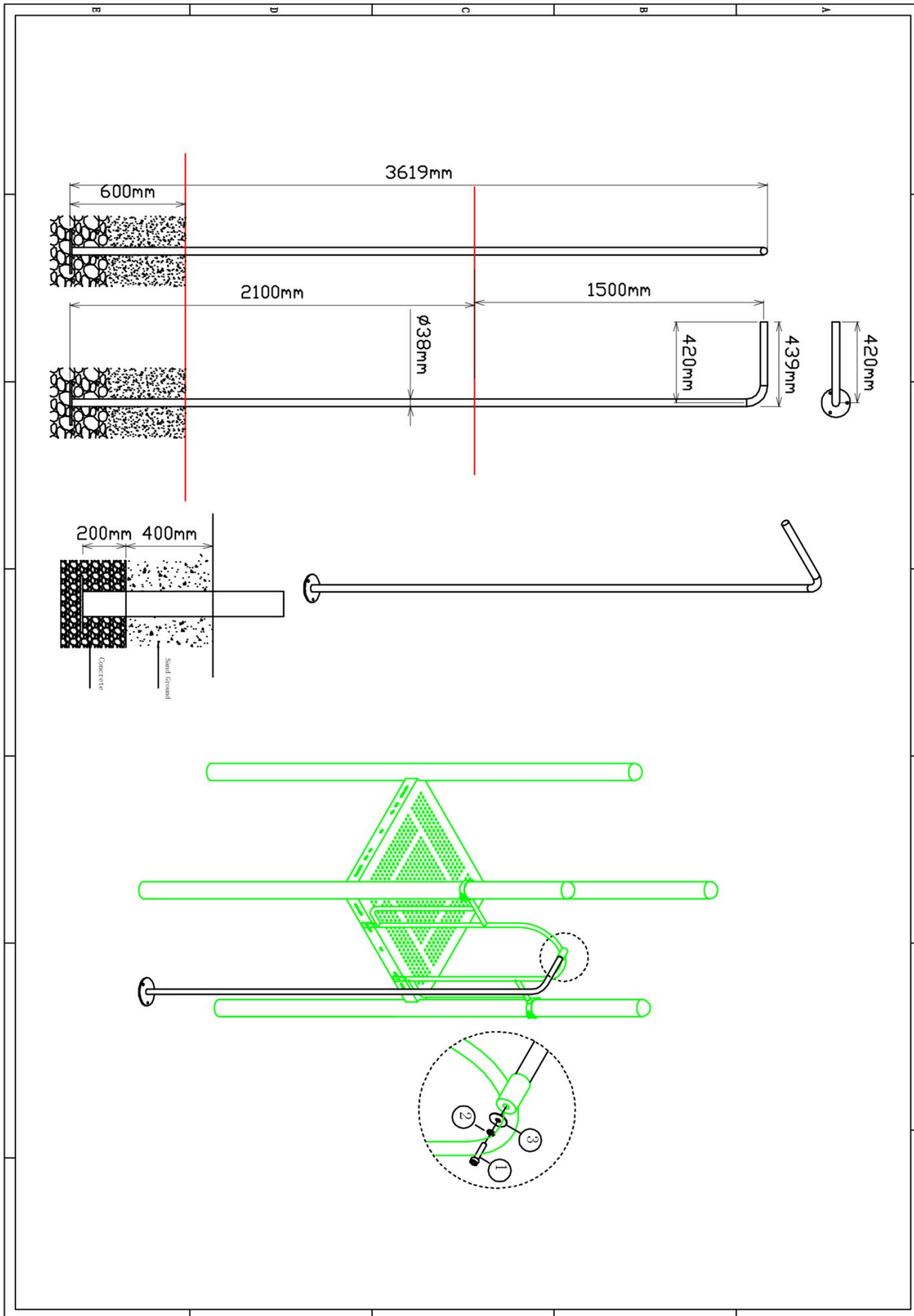

150cm Glijstang

STAP 1 van 1

Omschrijving: Bevestiging tussen de glijstang en het hek

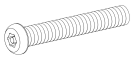
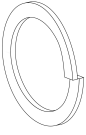
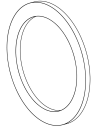
1 st. 150cm Glijstang	1 st. Torx M10X30	1 st. Veerring M10	1 st. Ring M10 (groot)
			

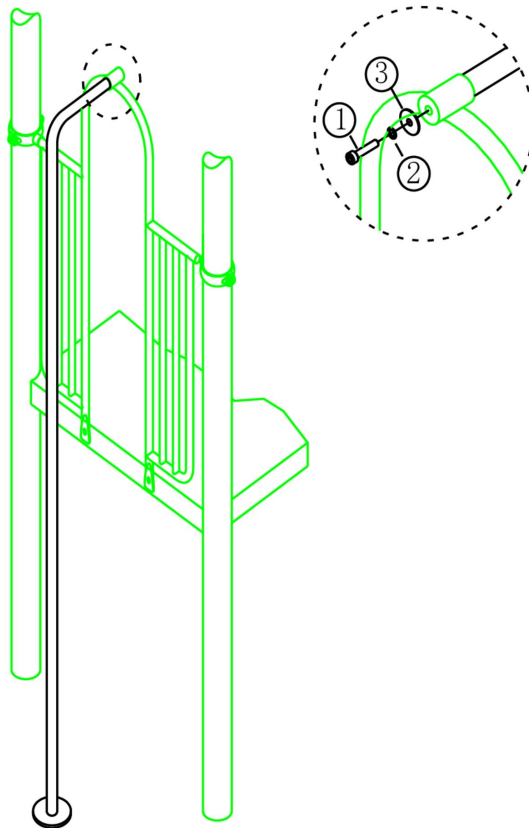

Bevestigings materiaal is per zakje verpakt en bovenstaande afbeelding zit in het zakje

Hekje zonder bevestiging (boven)



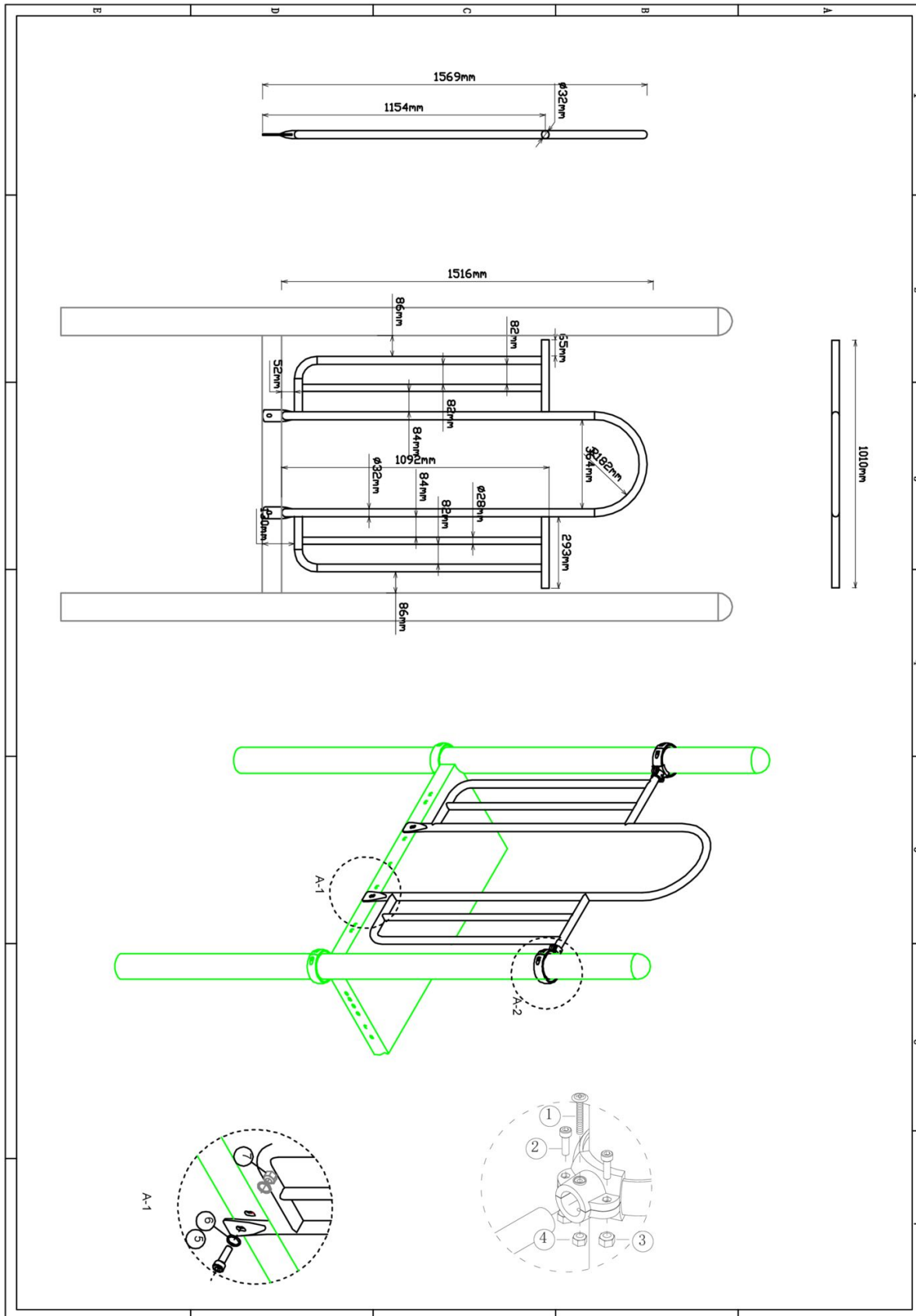



Hoofdafmetingen: 152x101cm

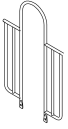

Hekje zonder bevestiging (boven)

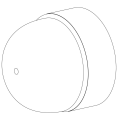
STAP 1 van 1

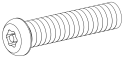
Omschrijving: Bevestiging van het hek tussen de vloer/staander

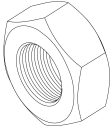
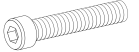
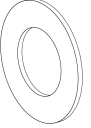
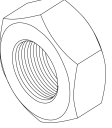
1 st. Hekje zonder bevestiging (boven)	2 st. Small clamp + ring	2 st. Afdekdop M10	2 st. Kruiskop M6X65
			
4 st. Torx M8X20	4 st. Lock Moer M8	2 st. Lock Moer M6	2 st. Bout M10X25
			
4 st. Ring M10 (middel)	2 st. Lock Moer M10		
			

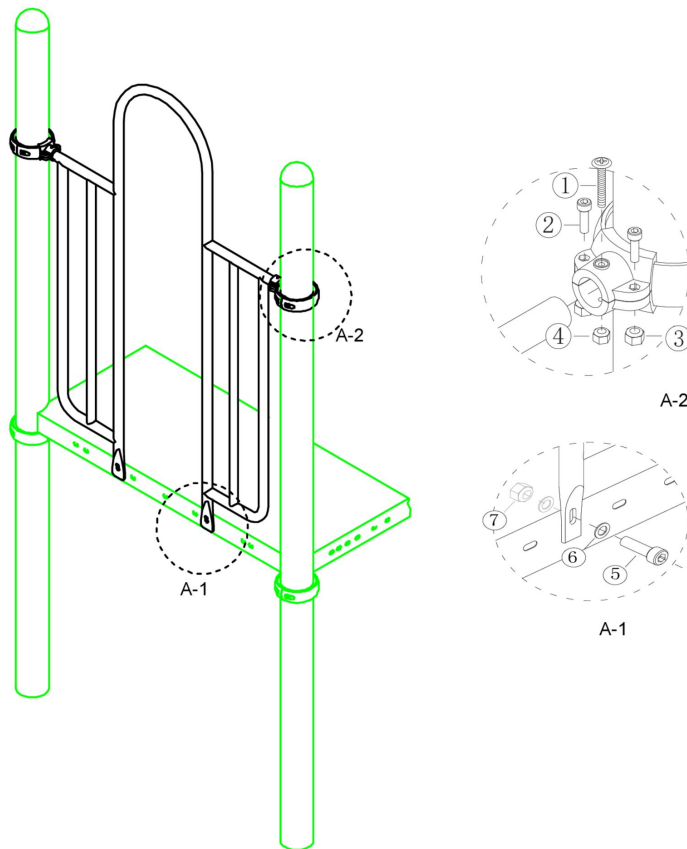

Bevestigings materiaal is per zakje verpakt en bovenstaande afbeelding zit in het zakje

Stangenopgang 150cm

Hoofdafmetingen: 3,2x101 (stang 3x)

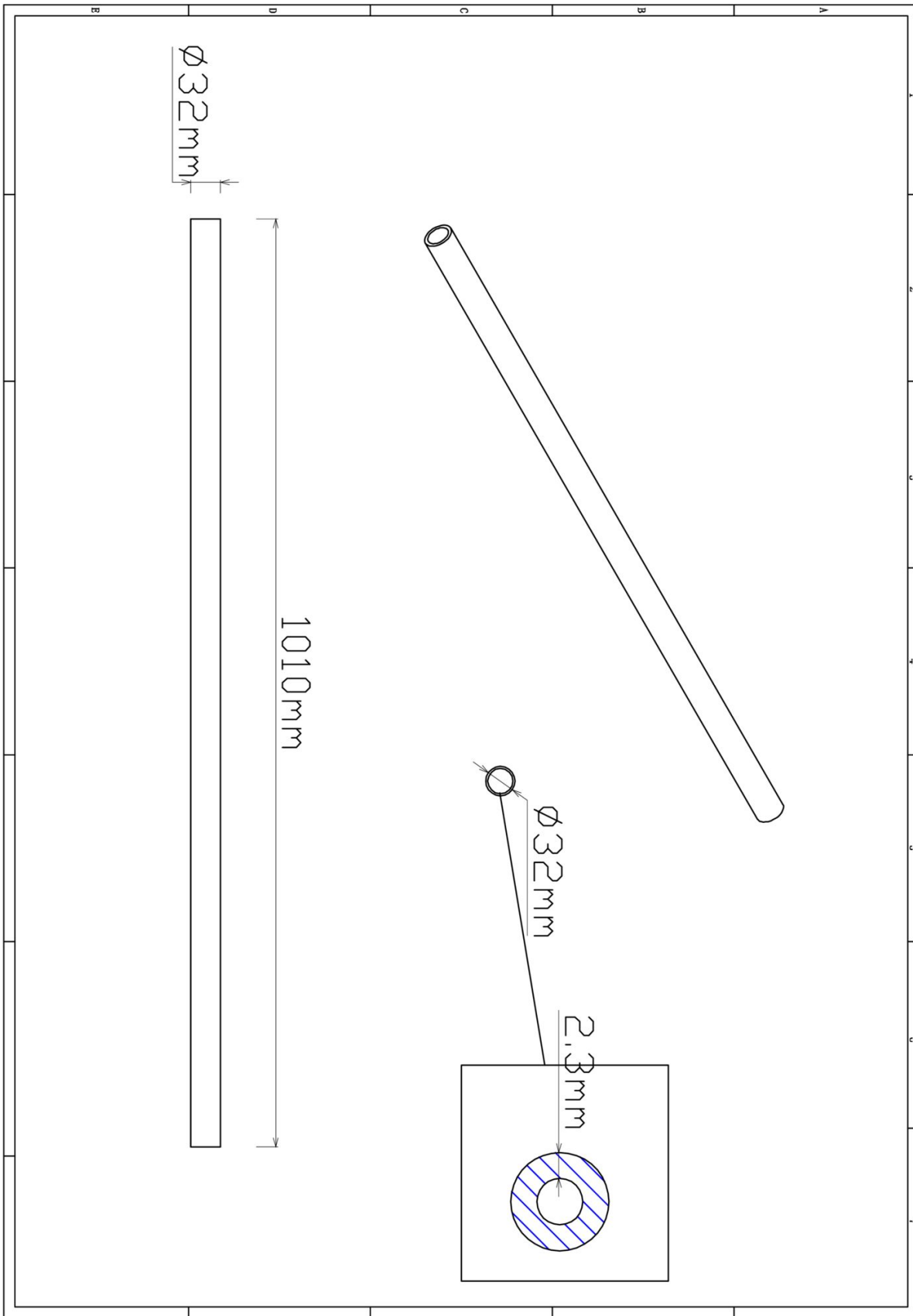



Stangenopgang 150cm

STAP 1 van 3

Omschrijving: Zelftap bouten aanbrengen aan de binnenkant van de palen

6 st. Zeskant M3X16
Zelftap

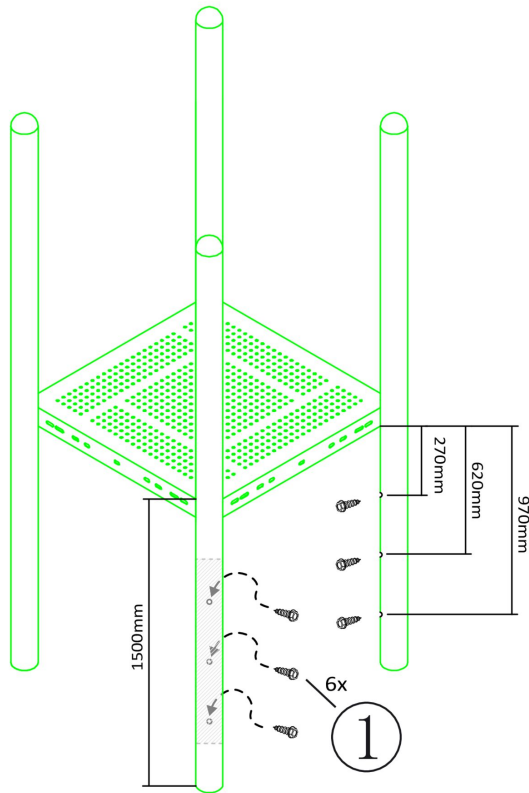
1



Bevestigings materiaal is per zakje verpakt en bovenstaande afbeelding zit in het zakje

Stangenopgang 150cm

STAP 2 van 3

Omschrijving: Koppelingsring over de schroef schuiven en vastzetten zodat de schroef niet meer zichtbaar is en de ring door de schroef niet kan zakken op de paal

6 st. Small clamp + ring

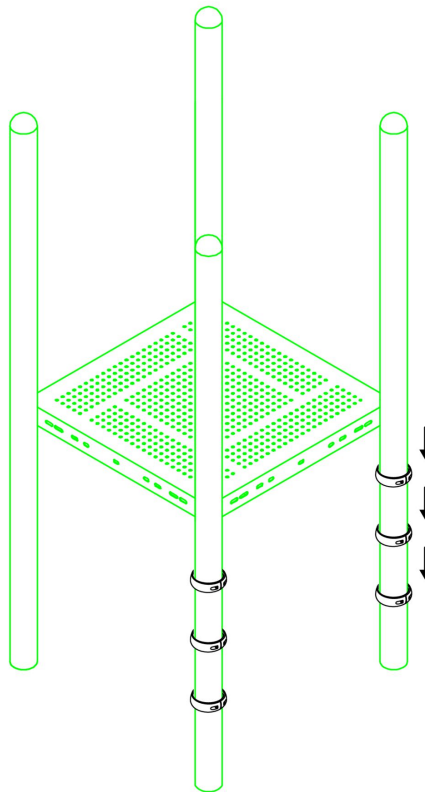



Bevestigings materiaal is per zakje verpakt en bovenstaande afbeelding zit in het zakje

Stangenopgang 150cm

STAP 3 van 3

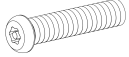
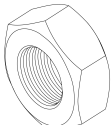
Omschrijving: Stang vastzetten met behulp van de klemmen

6 st. Kruiskop M6X65	12 st. Torx M8X20
1 	2 
12 st. Lock Moer M8	6 st. Lock Moer M6
3 	4 

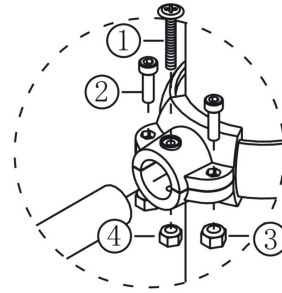
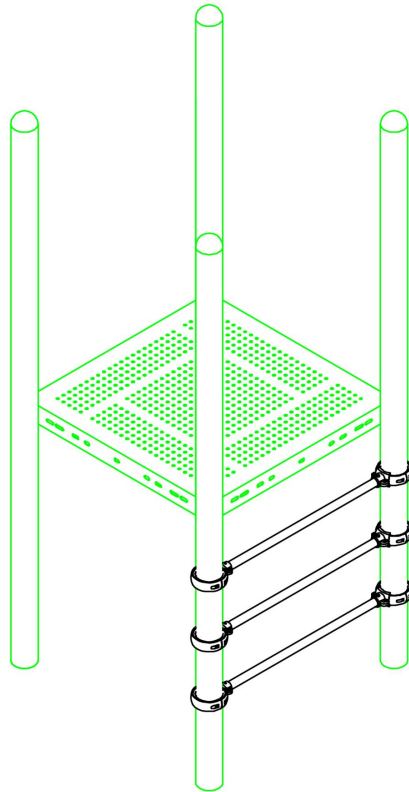

Bevestigings materiaal is per zakje verpakt en bovenstaande afbeelding zit in het zakje

Hek voor RVS glijbaan



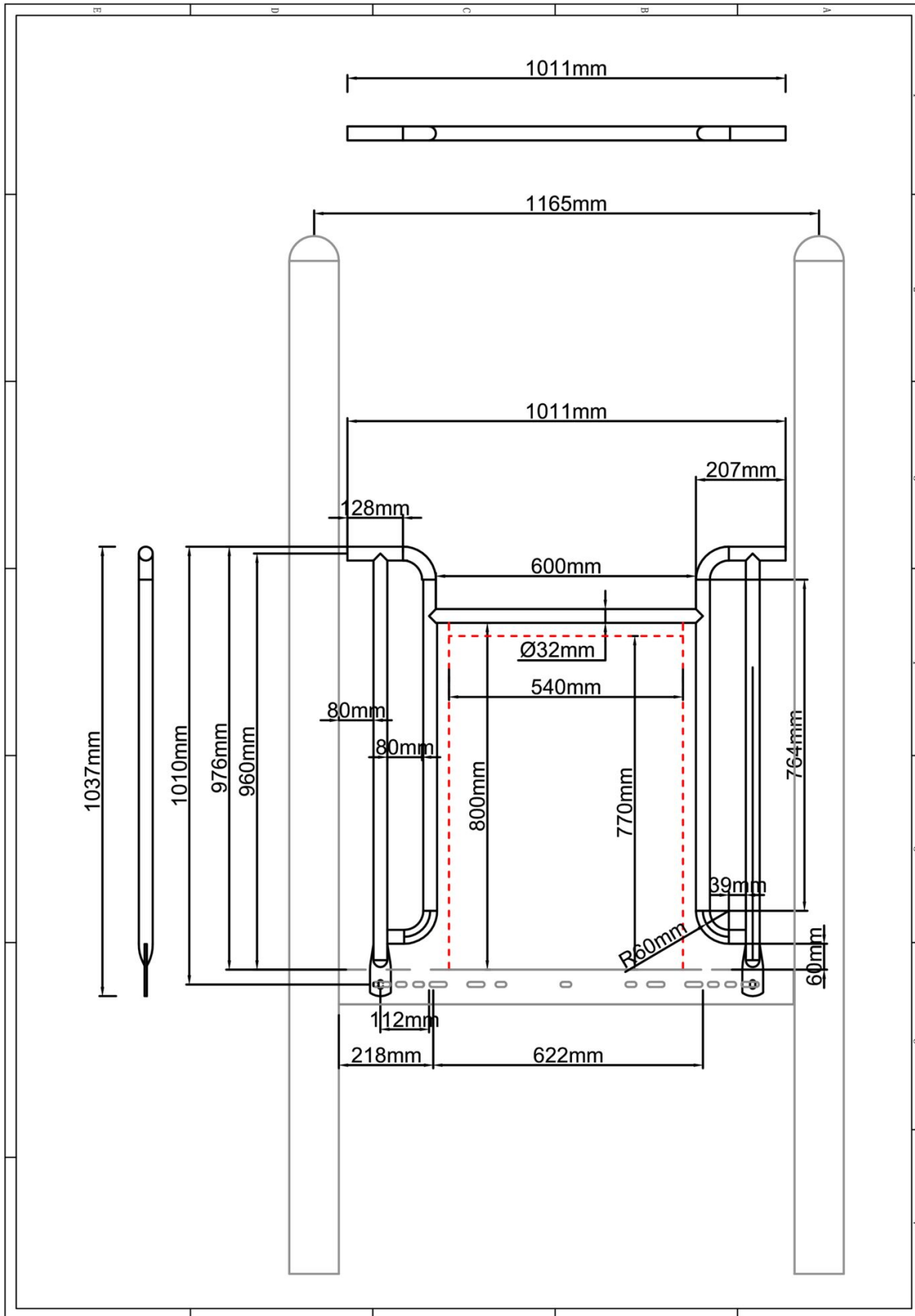

Hoofdafmetingen: 104x101cm

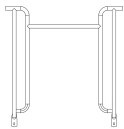

Hek voor RVS glijbaan

STAP 1 van 1

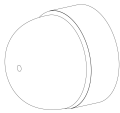
Omschrijving: Bevestiging tussen de vloer/staander en het hekje

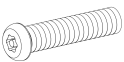
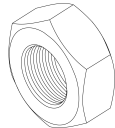
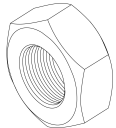
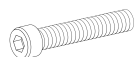
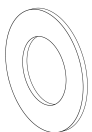
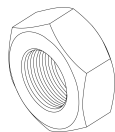
1 st. Hek voor RVS glijbaan	2 st. Small clamp + ring	2 st. Afdekdop M10	2 st. Kruiskop M6X65
			
4 st. Torx M8X20	4 st. Lock Moer M8	4 st. Lock Moer M6	2 st. Bout M10X25
			
4 st. Ring M10 (middel)	2 st. Lock Moer M10		
			

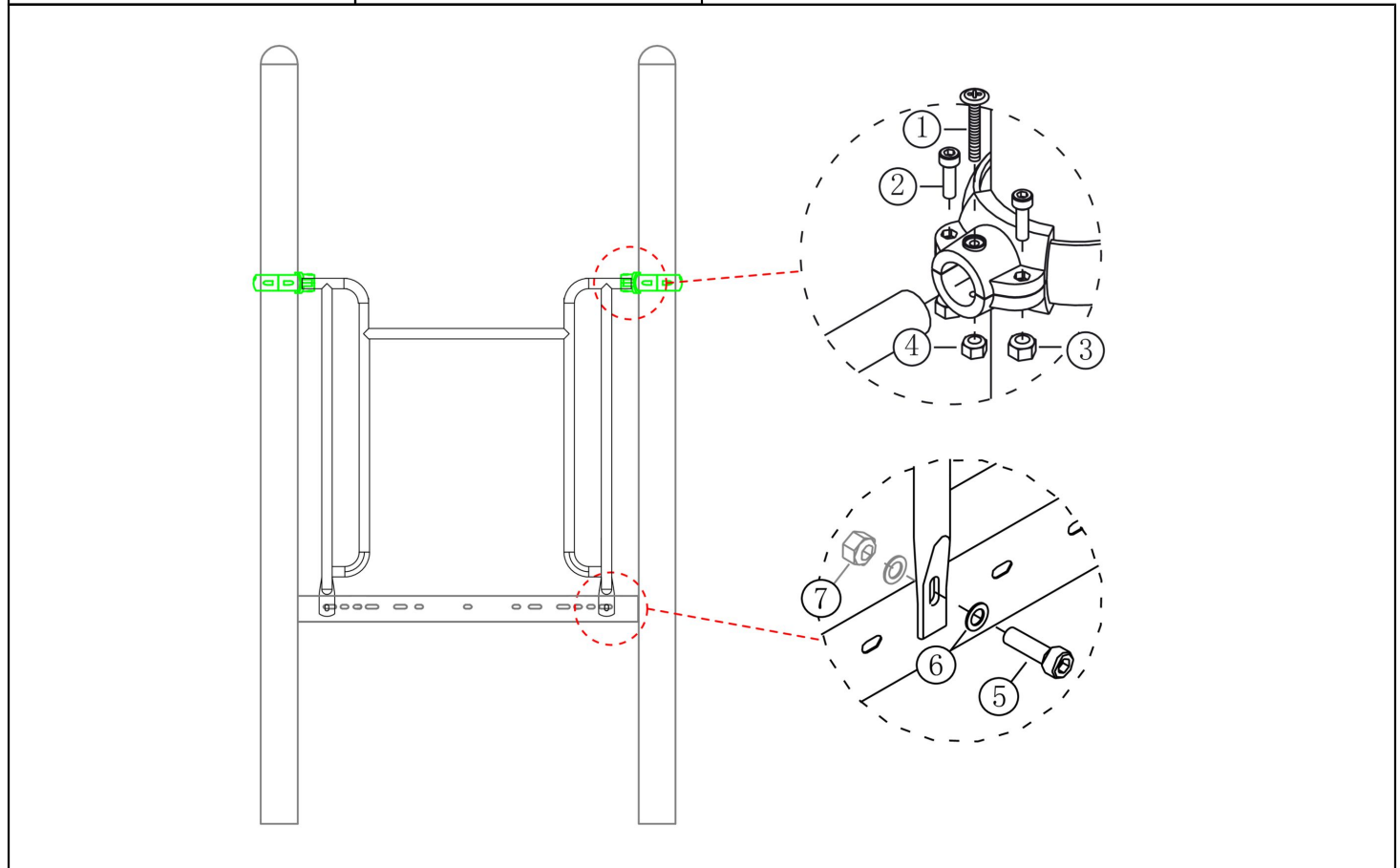

Bevestigings materiaal is per zakje verpakt en bovenstaande afbeelding zit in het zakje

RVS Glijbaan 150cm

Hoofdafmetingen: 250x297x54cm

alle afmetingen zijn in mm.

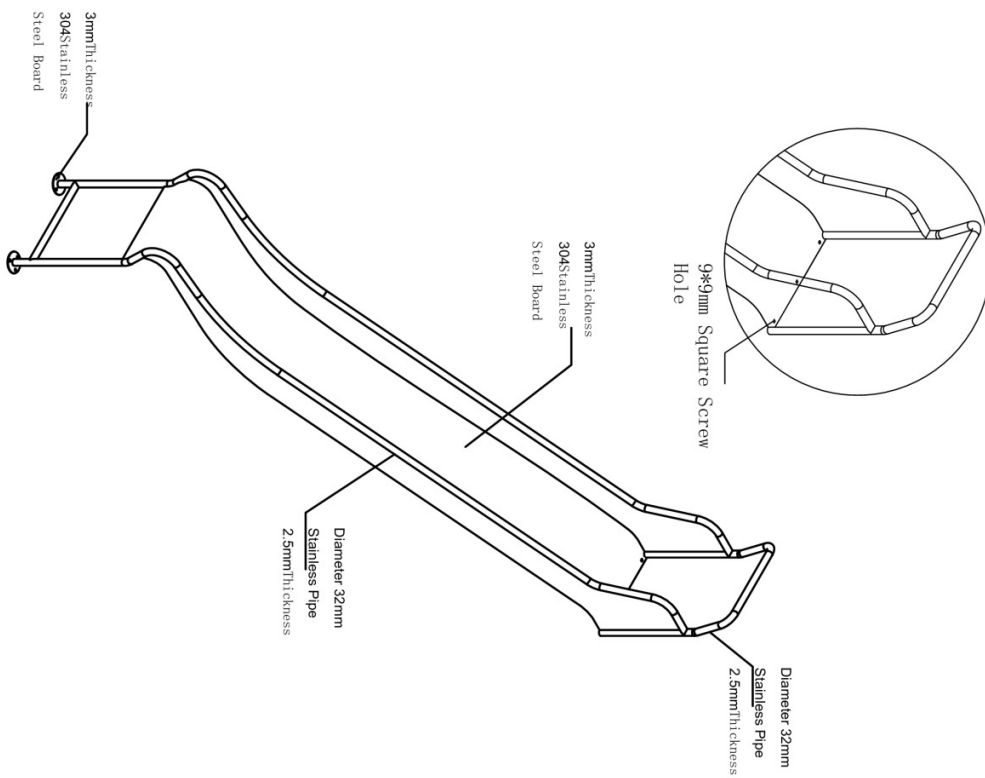
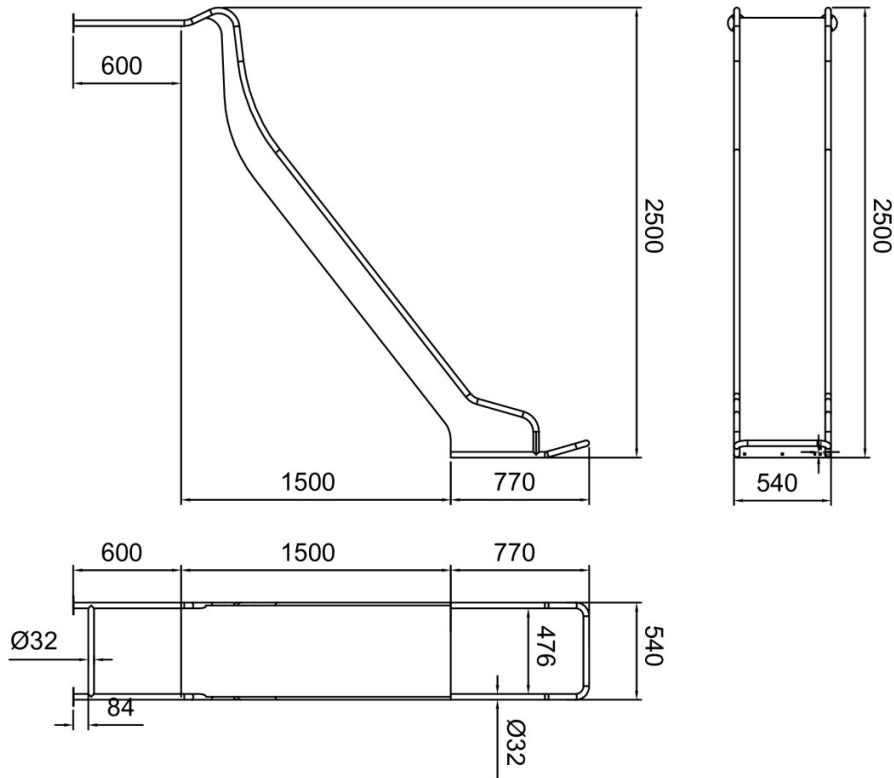

1500mm Slide

RVS Glijbaan 150cm

STAP 1 van 2

Omschrijving: Bevestigings gaten in de vloer boren volgens schema

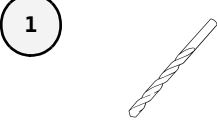
1 st. Boormachine	1 st. Boortje 8,5mm
	

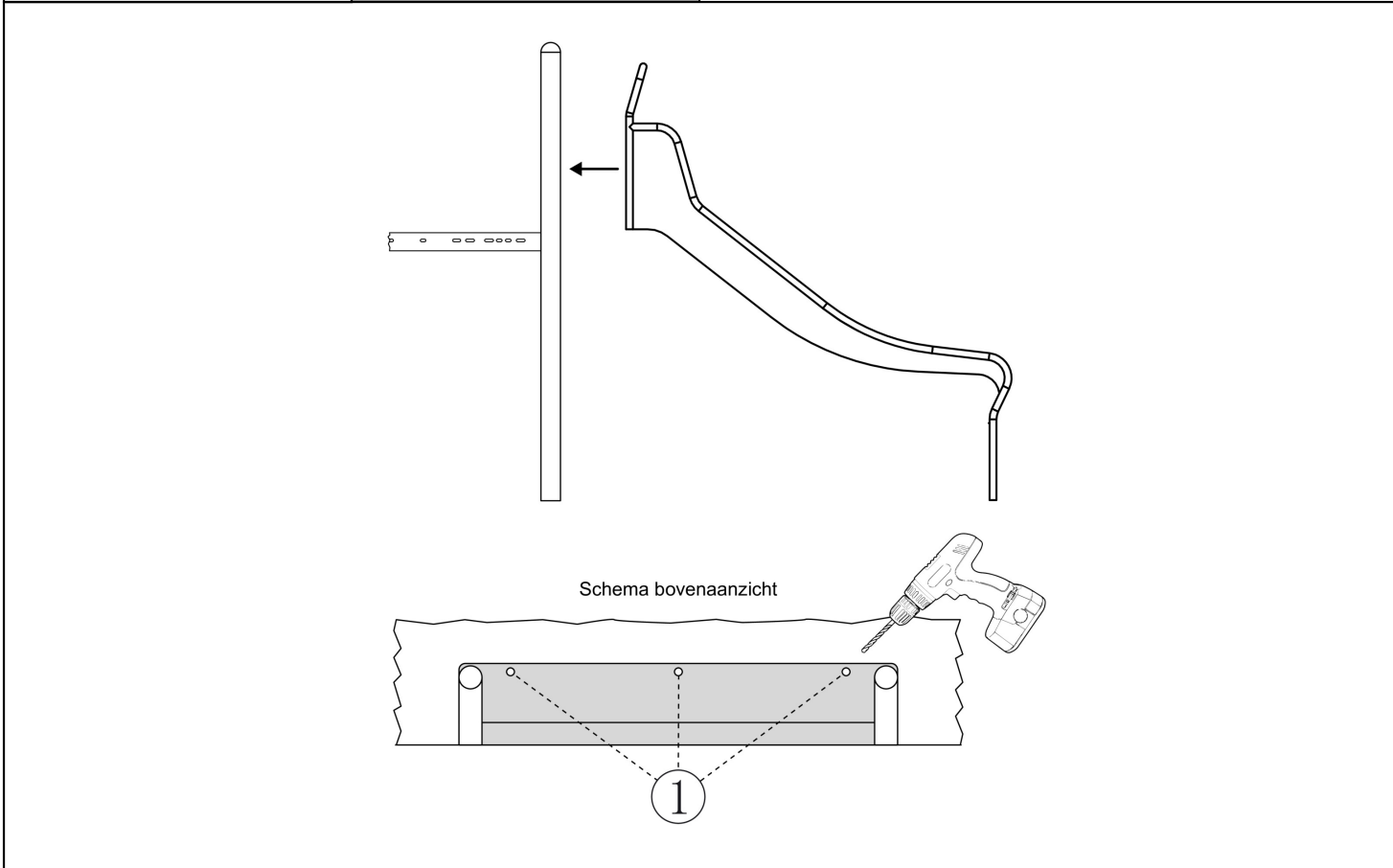

Bevestigings materiaal is per zakje verpakt en bovenstaande afbeelding zit in het zakje

RVS Glijbaan 150cm

STAP 2 van 2

Omschrijving: Glijbaan op de vloer bevestigen met bijgeleverde montagepakket.

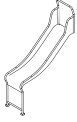
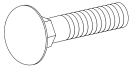
1 st. RVS Glijbaan 90cm	2 st. Slotbout M8X20	
		
2 st. Ring M8 (middel)	2 st. Lock Moer M8	2 st. Afdekdop M8
