



TnT speeltoestellen

Montagehandleiding

CM-1340



Toestel	CM-1340
Datum montagehandleiding	21-05-2026

Beste klant van TnT Speeltoestellen,

Wij danken u voor het aanschaffen en installeren van een speeltoestel van TnT Speeltoestellen. Wij waarderen het vertrouwen dat u in ons bedrijf heeft geplaatst en streven ernaar om uw vertrouwen meer dan waar te maken!

Dit is uw TnT speeltoestellen montagehandleiding.

Wij hebben deze handleiding specifiek voor het product ontworpen, waarop eveneens de toe te passen onderdelen zijn genoemd.

Ook vindt u het grondplan met de benodigde valruimte volgens norm NEN-EN1176-1 : 2017.

Bewaart u dit document bij uw logboek. Nogmaals willen wij u bedanken voor de aankoop van dit speeltoestel. Wij zien uit naar uw volgende speelproject.

Met vriendelijke groet, TnT Speeltoestellen

Inhoudsopgave

Aanzichten 3D	2
Onderdelenlijst	4
Veiligheidsruimtes	6
Zijaanzichten	7
Plattegrond palenplan	9
Paalmaten	10
Paaldata	11
Onderdeel handleidingen	12
Staander 290cm	13
Staander 350cm	15
Vloer vierkant (vloer_vierkant)	17
Tussentrap met railing 60cm (trap_60cm_tussen)	19
Metalen hekje (metalen_hekje)	23
Glijstang (glijstang_150cm)	25
Slangen opgang (klimrek_slang_150cm)	29
Standaard trap (opgang_trap)	33
Opgang wikkel (opgang_wikkel_150cm)	37
Glijbaan RVS (glijbaan_90cm_metaal)	41
Glijbaan RVS (glijbaan_150cm_metaal)	46
Bankje (bankje)	51
Tussenstepje 67cm (tussenstepje_67cm)	53

Aanzichten 3D



Aanzicht 1



Aanzicht 2

Aanzichten 3D









Aanzicht 3



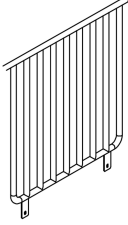
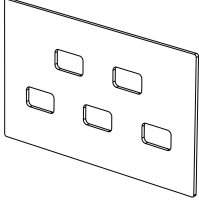
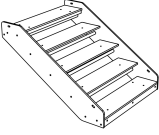
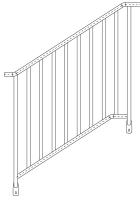
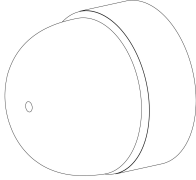
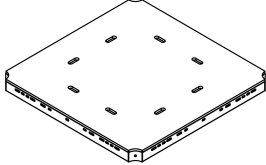
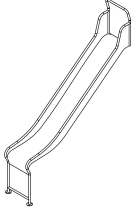
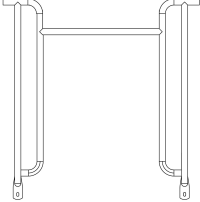
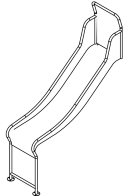
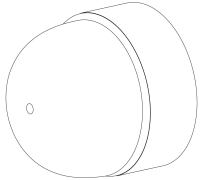
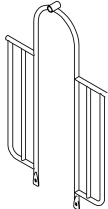

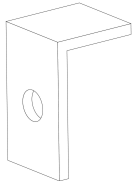
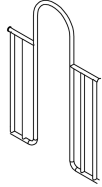
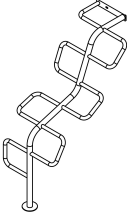
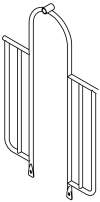
Aanzicht 4

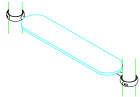
Onderdelenlijst

<p>8x Staander 350cm 350x11,5cm</p> 	<p>2x Staander 290cm 290x11,5cm</p> 	<p>2x Balustrade metaal 105x101cm</p> 	<p>1x Tussenstap 60cm HPL 98x30x1,5cm</p> 
<p>1x 60cm tussentrap HPL 117x97x75cm</p> 	<p>1x 60cm tussentrap railing HPL (per 2stuks) 166x116,5cm</p> 	<p>32x Afdekdop M10 M10</p> 	<p>3x Vloer vierkant HPL 117x117x8,5cm</p> 
<p>1x RVS Glijbaan 150cm 250x297x54cm</p> 	<p>2x Hek voor RVS glijbaan 104x101cm</p> 	<p>1x RVS Glijbaan 90cm 179x227x54cm</p> 	<p>21x Afdekdop M8 M8</p> 
<p>1x Hekje tbv glijstang 152x101cm</p> 	<p>1x 150cm Glijstang 362x42cm</p> 	<p>2x Hoekje</p> 	<p>1x Hekje tbv Snake climber 138x101cm</p> 
<p>1x 150cm Snake climber 209x67cm</p> 	<p>1x Hekje tbv: B, Pod en Curly Climber 152x101cm</p> 	<p>1x 150cm Curly climber 364x67cm</p> 	<p>2x Bankje 2.0 116x22x4cm</p> 

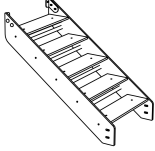
Onderdelenlijst (vervolgd)

<p>1x 90cm trap HPL 101x64x19cm</p>	<p>1x 90cm trapleuningen HPL (2 stuks) 248x103x18cm</p>
	

Veiligheidsruimtes

Geachte klant,

Zorg er altijd voor dat alle veiligheidsruimtes zoals aangegeven in ieder geval gehaald worden, dit zijn de minimale vereiste ruimtes voor een veilig gebruik van het speeltoestel.

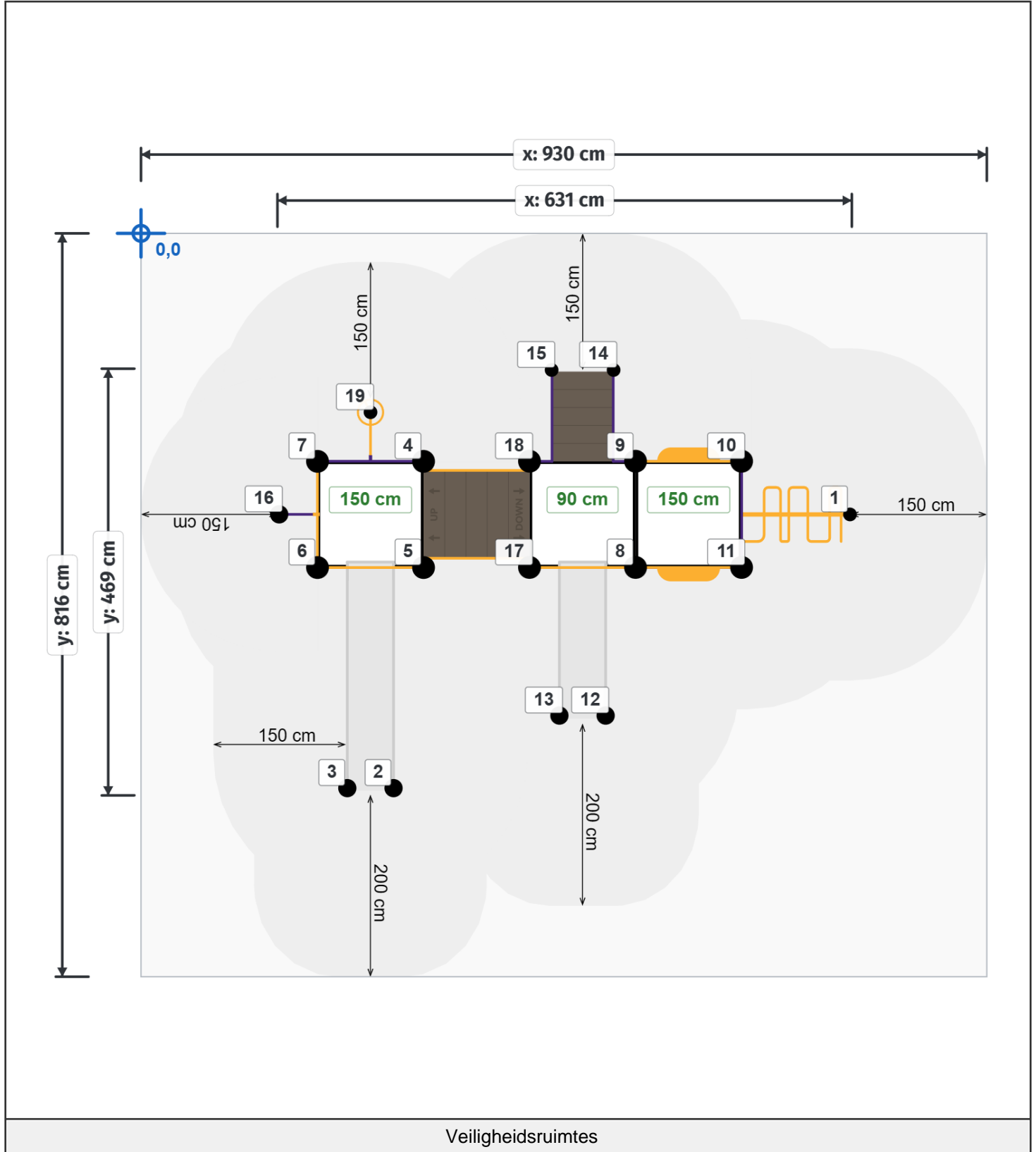

Zijaanzichten

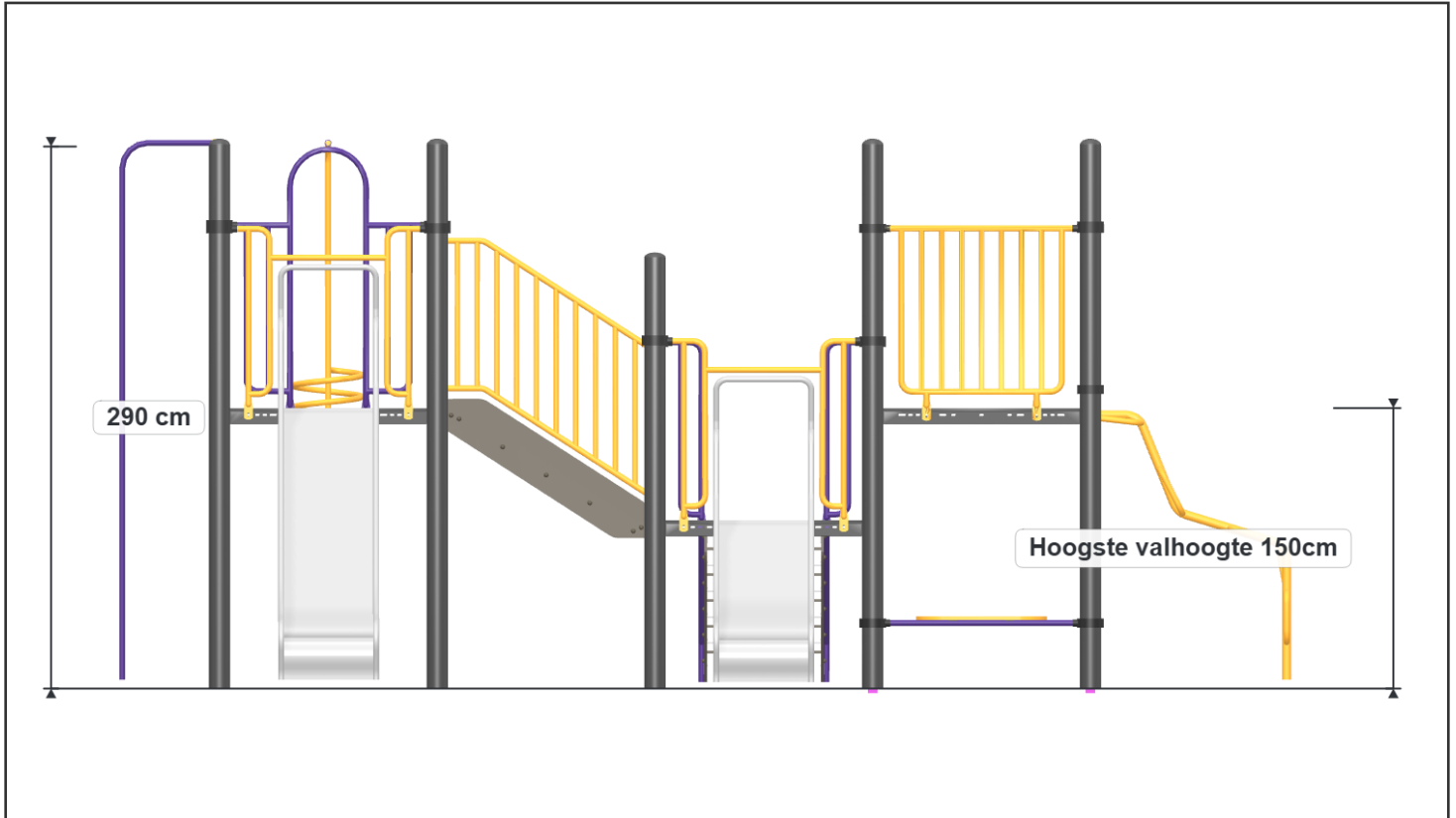

Aanzicht 1

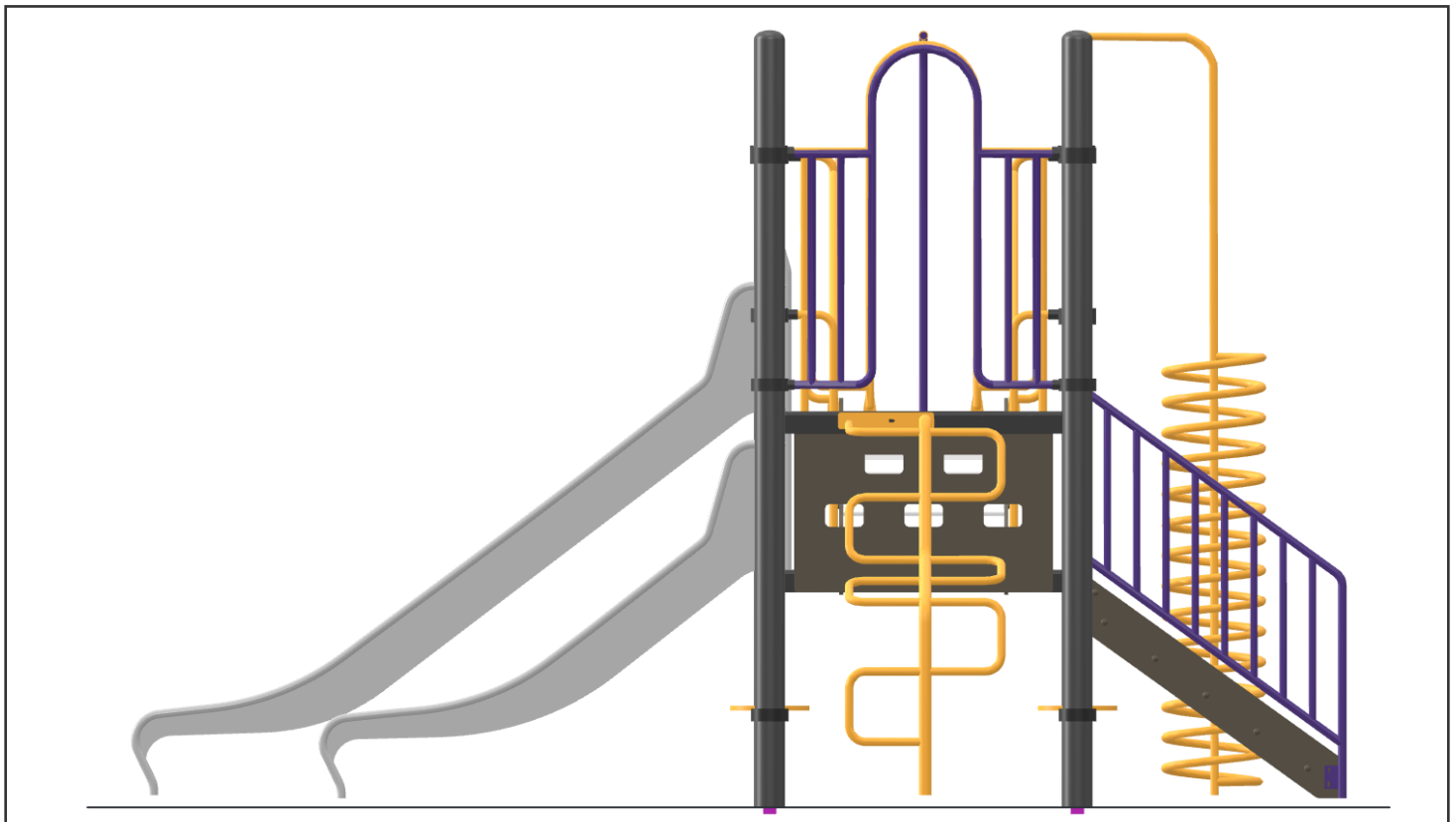

Aanzicht 2

Zijaanzichten



Aanzicht 3

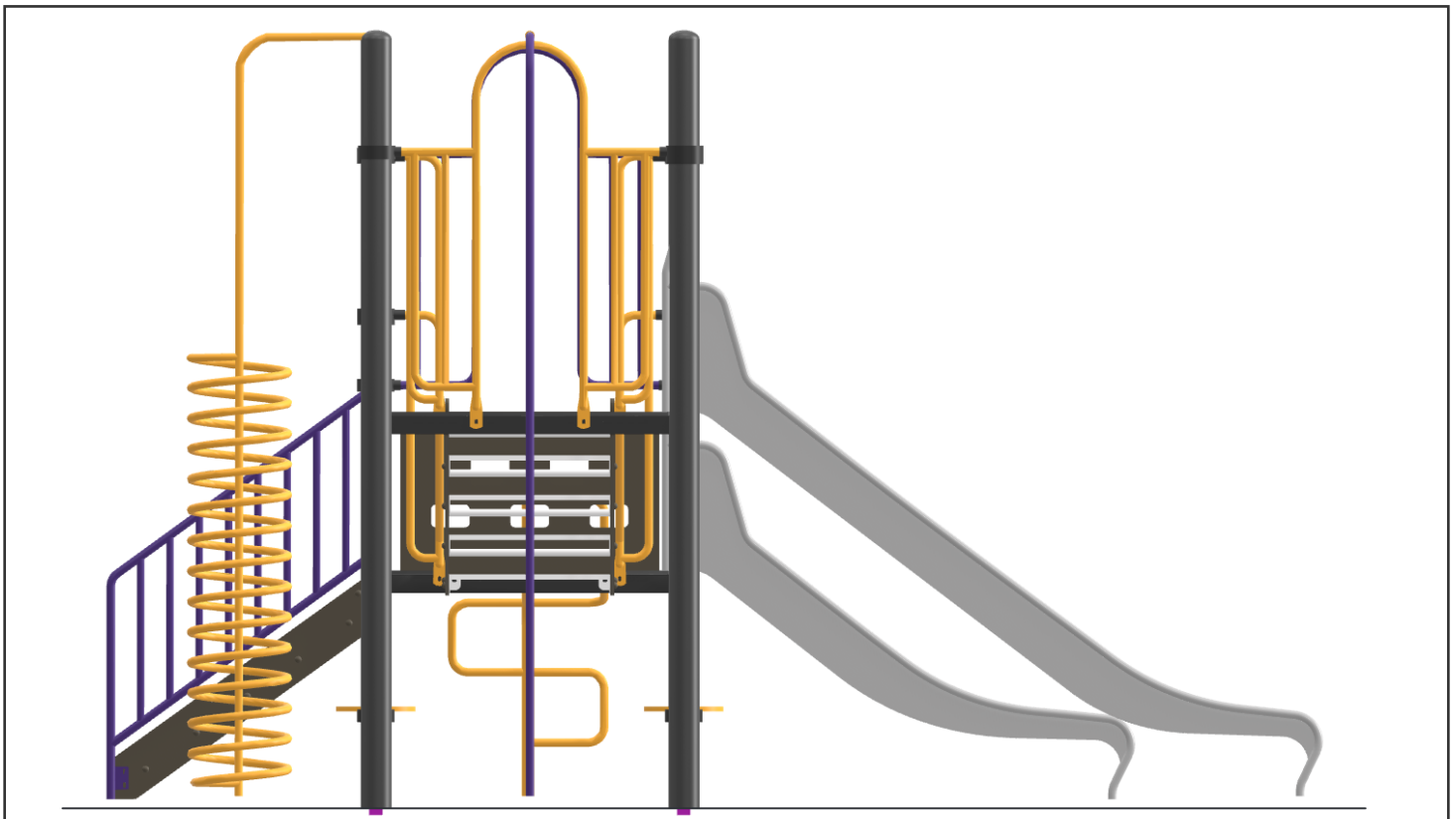

Aanzicht 4

Plattegrond palenplan

U kunt van deze tekening niet afmeten!

Voor de betonfundatie heeft u 37,5 kg snelbeton per staander nodig.

Voor de overige onderdelen (Glijstangen, Climbers, Glijbaan voeten) 25 kg snelbeton.

Houdt u er rekening mee dat de betonfundatie minimaal 400mm onder het maaiveld blijft, zoals op de tekening afgebeeld.

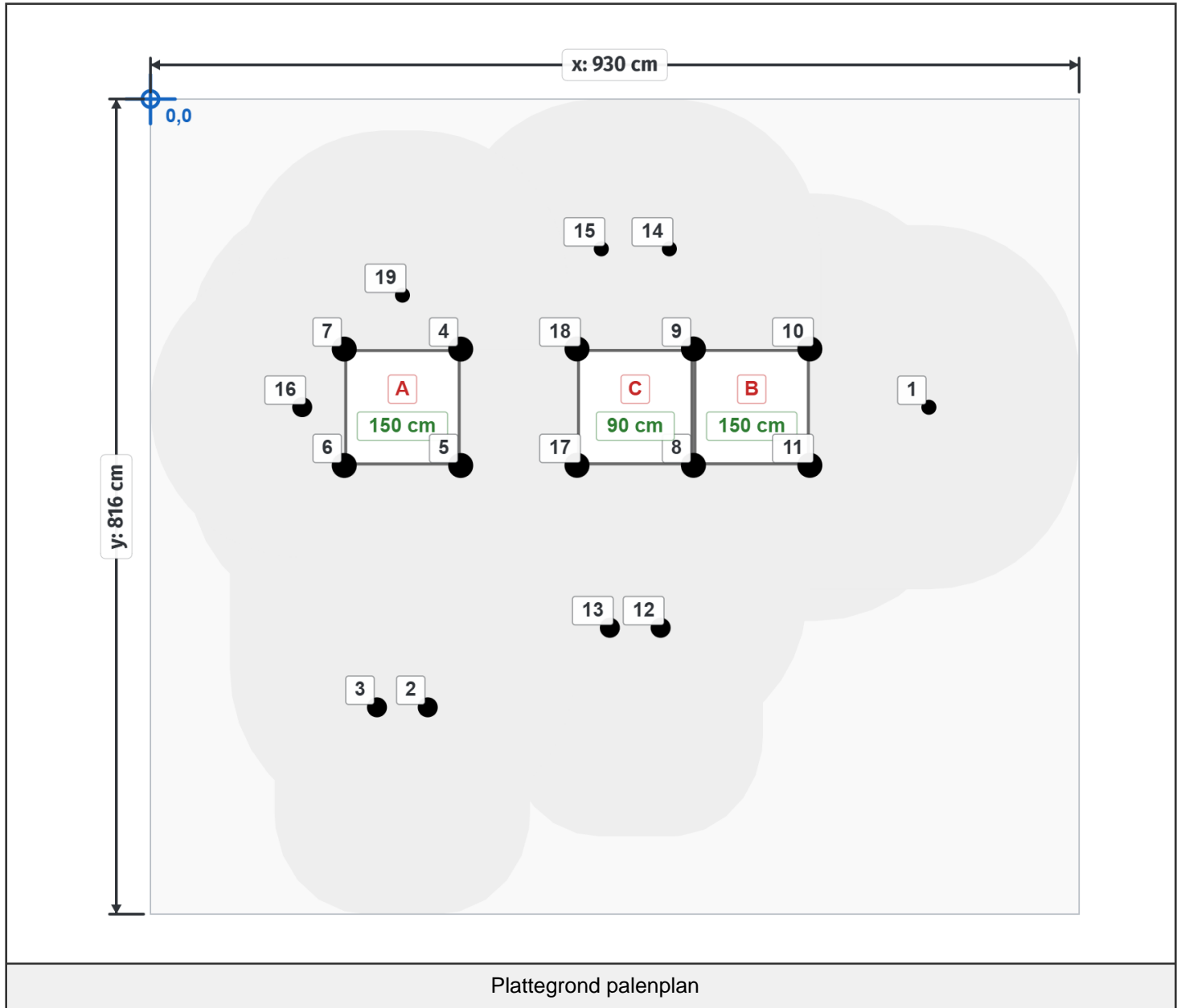

Plattegrond palenplan

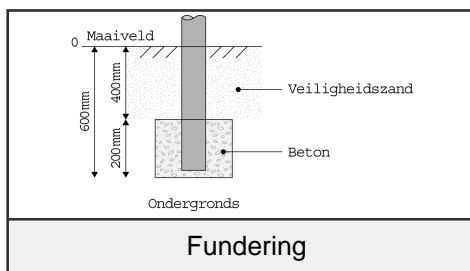

Fundering

Paaldata

Staanders			
Label	X	Y	Hoogte
1	779 cm	309 cm	0 cm
2	278 cm	609 cm	0 cm
3	227 cm	609 cm	0 cm
4	311 cm	251 cm	350 cm
5	311 cm	367 cm	350 cm
6	194 cm	367 cm	350 cm
7	194 cm	251 cm	350 cm
8	544 cm	367 cm	350 cm
9	544 cm	251 cm	350 cm
10	660 cm	251 cm	350 cm
11	660 cm	367 cm	350 cm
12	511 cm	529 cm	0 cm
13	460 cm	529 cm	0 cm
14	520 cm	150 cm	0 cm
15	452 cm	150 cm	0 cm
16	152 cm	309 cm	0 cm
17	427 cm	367 cm	290 cm
18	427 cm	251 cm	290 cm
19	253 cm	197 cm	0 cm

Vloeren	
Label	Hoogte
A	150 cm
B	150 cm
C	90 cm

Onderdeel handleidingen

Op de volgende pagina's van dit document vindt u alle individuele onderdelen met bijbehorende technische tekeningen en eventuele montage instructies.

Staander 290cm

Hoofdafmetingen: 290x11,5cm

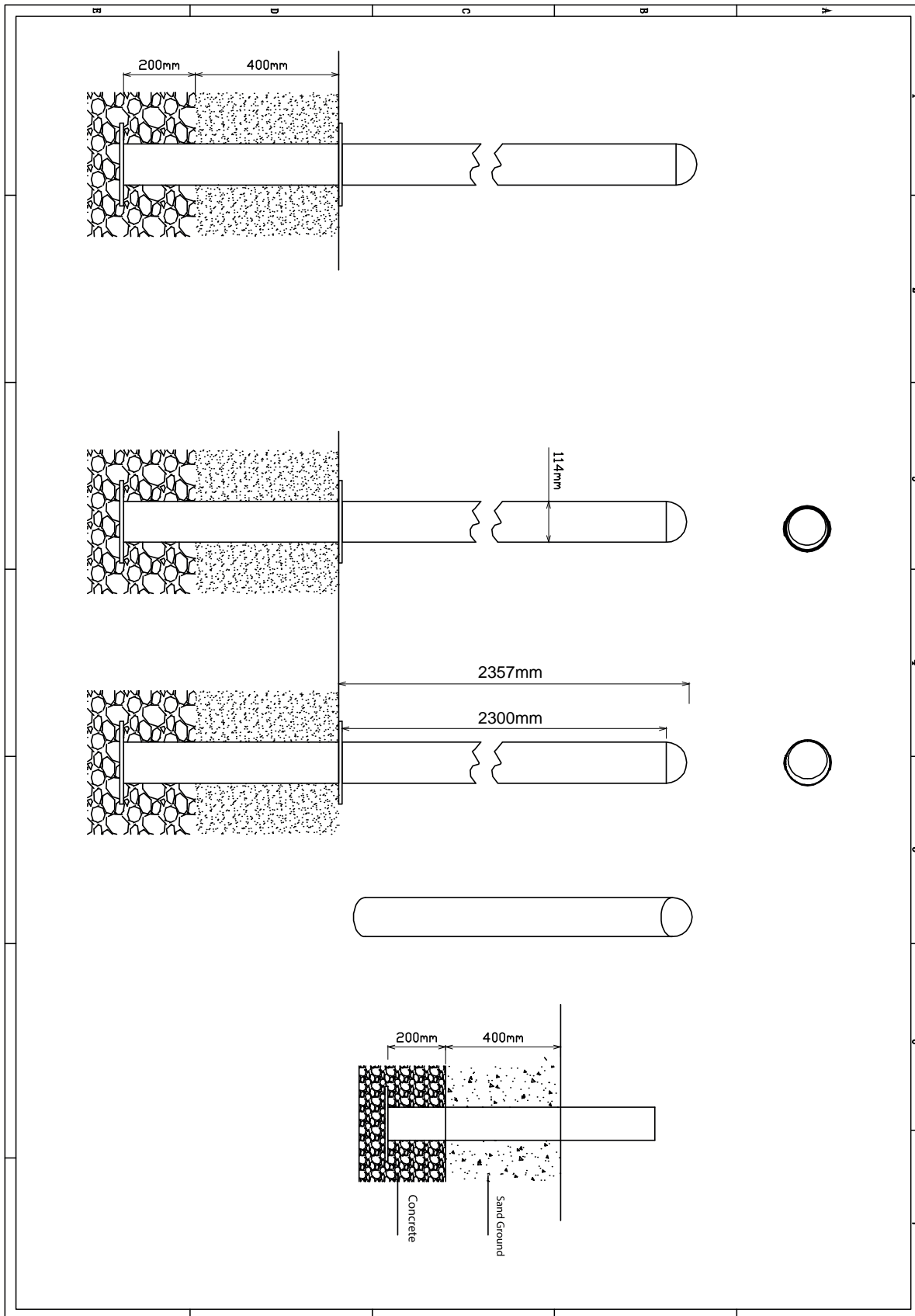



Staander

STAP 1 van 1

Omschrijving: Paalkap losdraaien en opnieuw bevestigen met loctite op het draadeind

1 st. Loctite

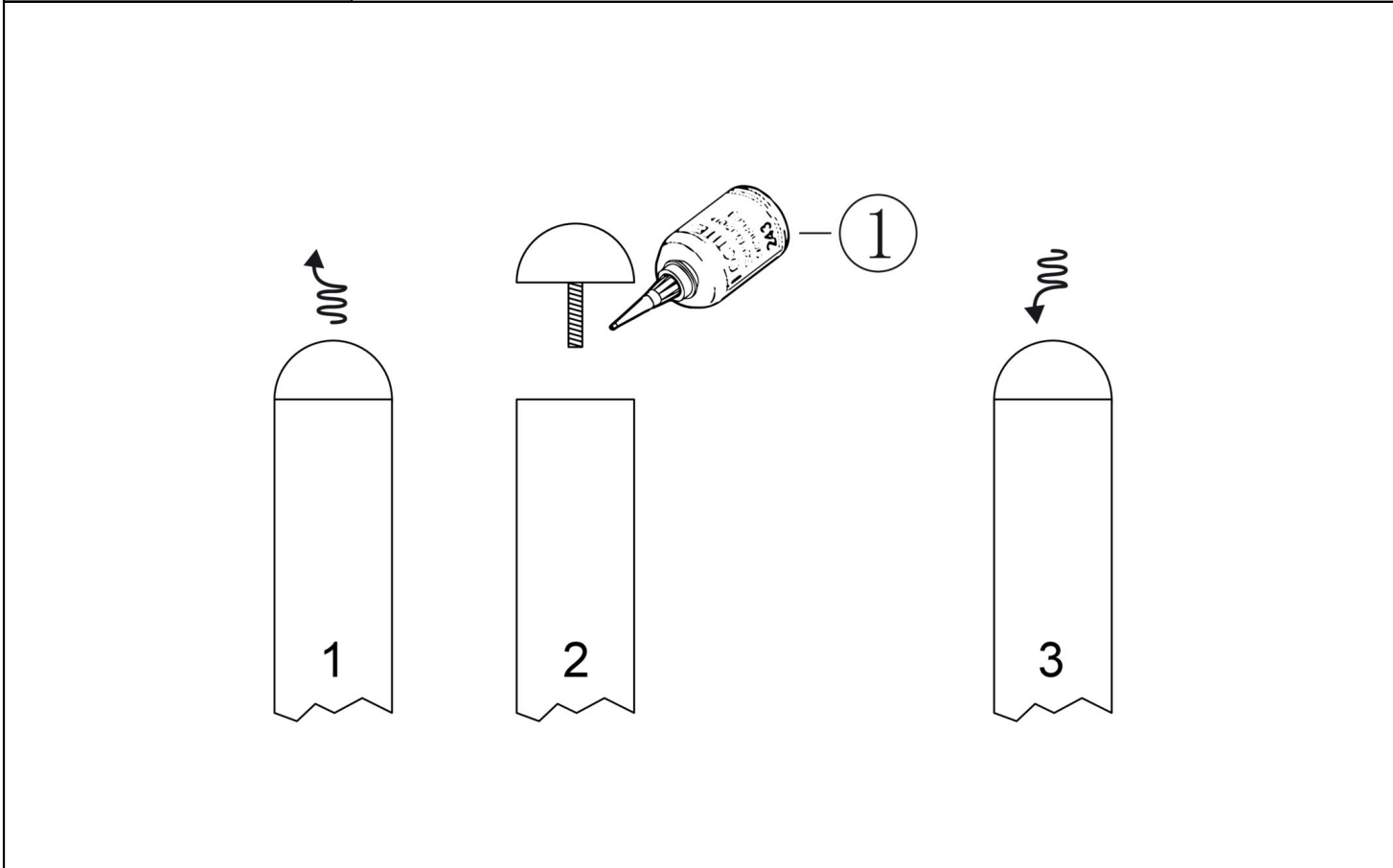
1



Bevestigings materiaal is per zakje verpakt en bovenstaande afbeelding zit in het zakje

Staander 350cm

Hoofdafmetingen: 350x11,5cm

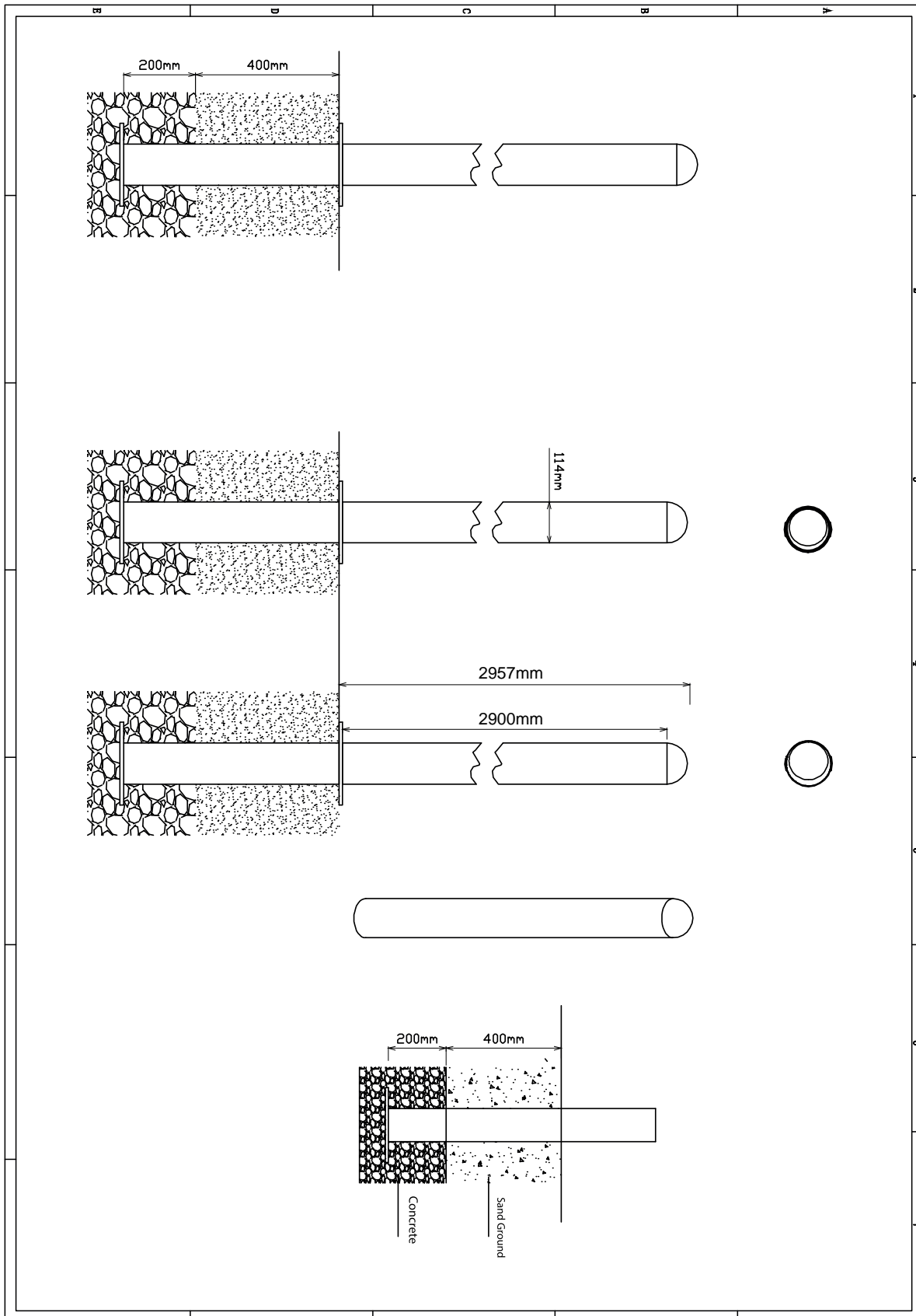

Staander

STAP 1 van 1

Omschrijving: Paalkap losdraaien en opnieuw bevestigen met loctite op het draadeind

1 st. Loctite

1 

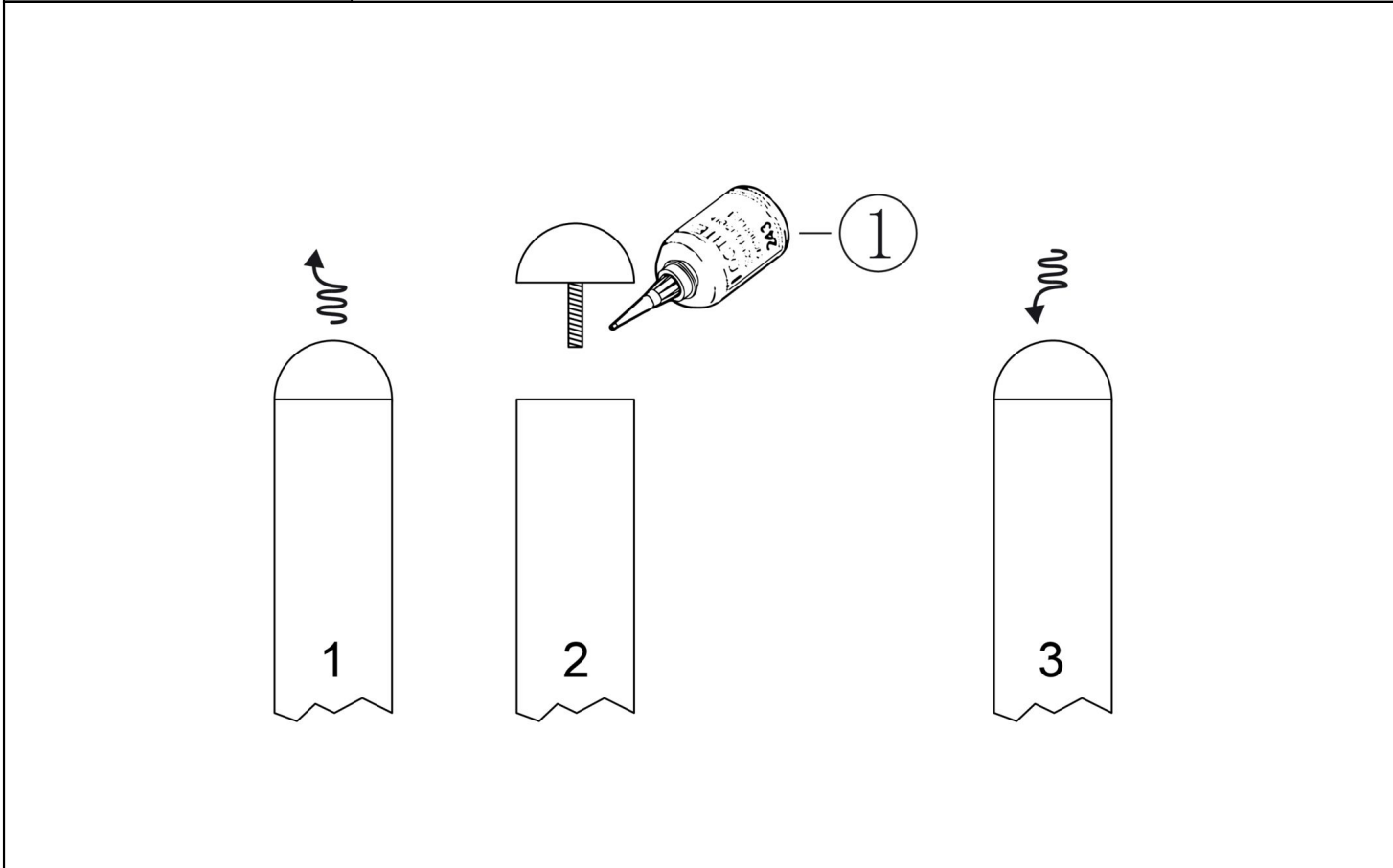

Bevestigings materiaal is per zakje verpakt en bovenstaande afbeelding zit in het zakje

Vloer vierkant HPL

Hoofdafmetingen: 117x117x8,5cm

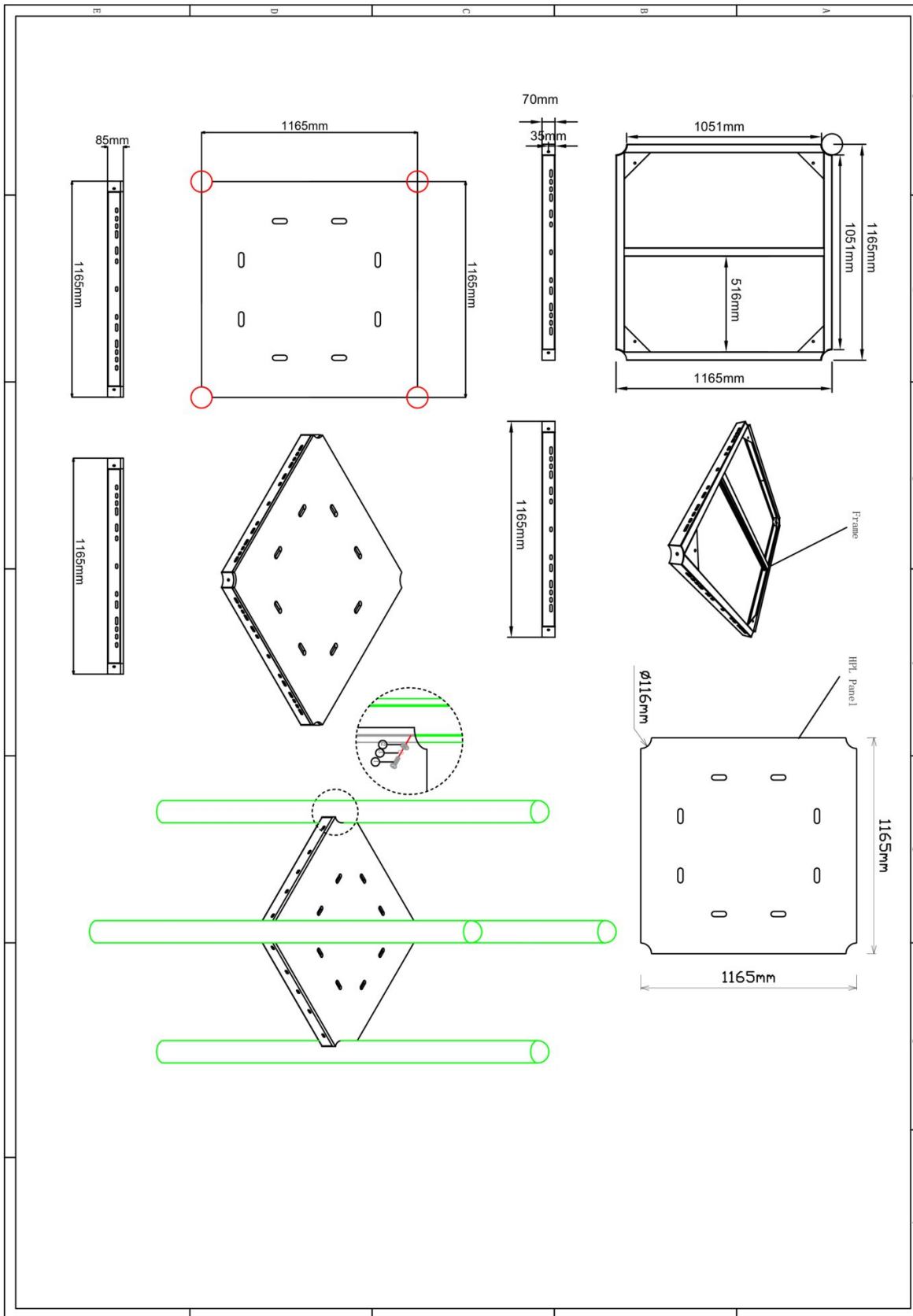

Vloer vierkant HPL

STAP 1 van 1

Omschrijving: Bevestiging van de vloer aan de staander. In de staander zitten al voor gemonteerde M10 bussen op de juiste hoogte waar de bout ingedraaid dienen te worden.

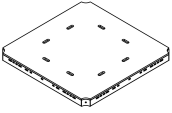
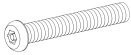
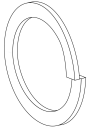
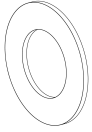
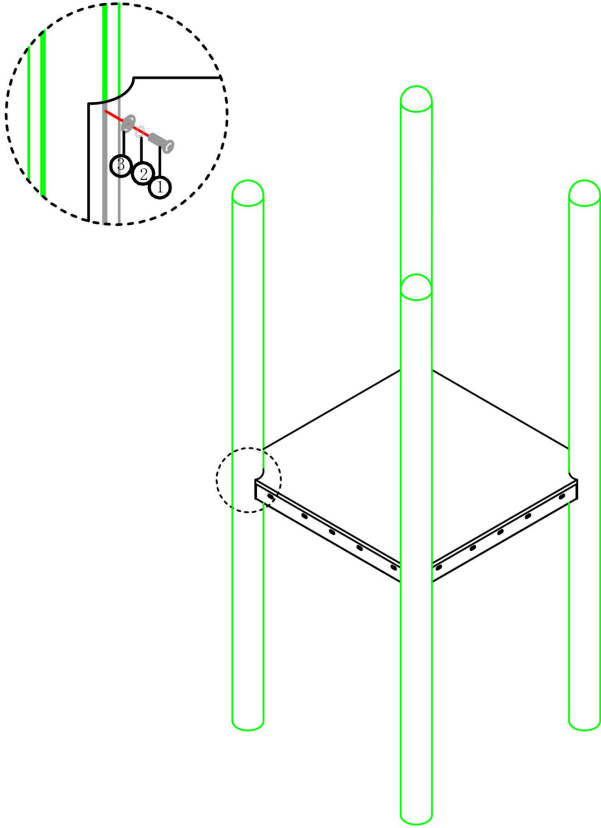
1 st. Vloer vierkant HPL	4 st. Torx M10X30	4 st. Veerring M10	4 st. Ring M10 (middel)
	<p>1</p> 	<p>2</p> 	<p>3</p> 
			
<p>Bevestigings materiaal is per zakje verpakt en bovenstaande afbeelding zit in het zakje</p>			

60cm tussentrap HPL

Hoofdafmetingen: 117x97x75cm

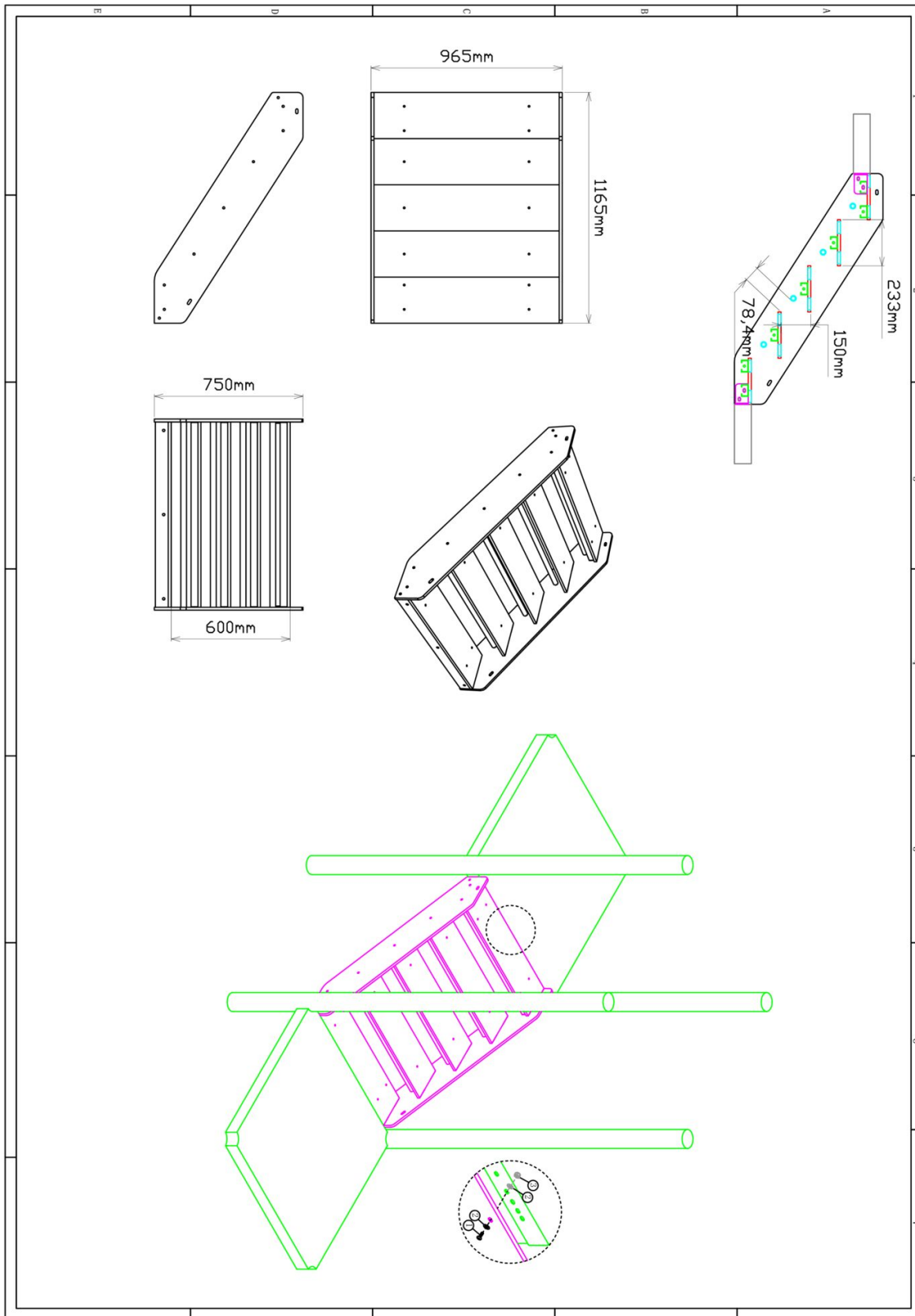

60cm tussentrap HPL

STAP 1 van 1

Omschrijving: Bevestiging tussen de trap en de vloeren

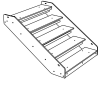
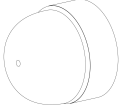
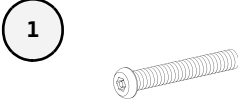
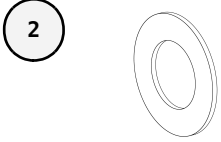
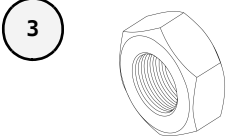
1 st. 60cm tussentrap HPL	6 st. Afdekdop M10	6 st. Torx M10X30	12 st. Ring M10 (middel)
			
6 st. Lock Moer M10			
			

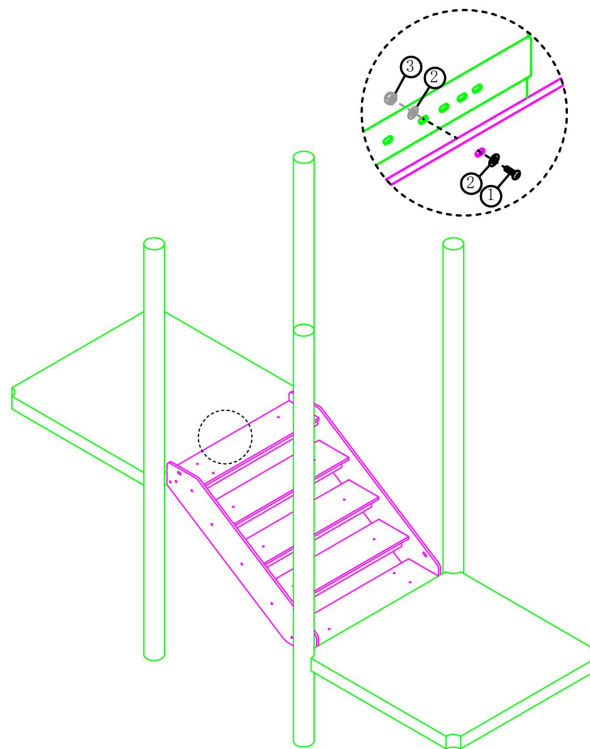

Bevestigings materiaal is per zakje verpakt en bovenstaande afbeelding zit in het zakje

60cm tussentrap railing HPL (per 2stuks)

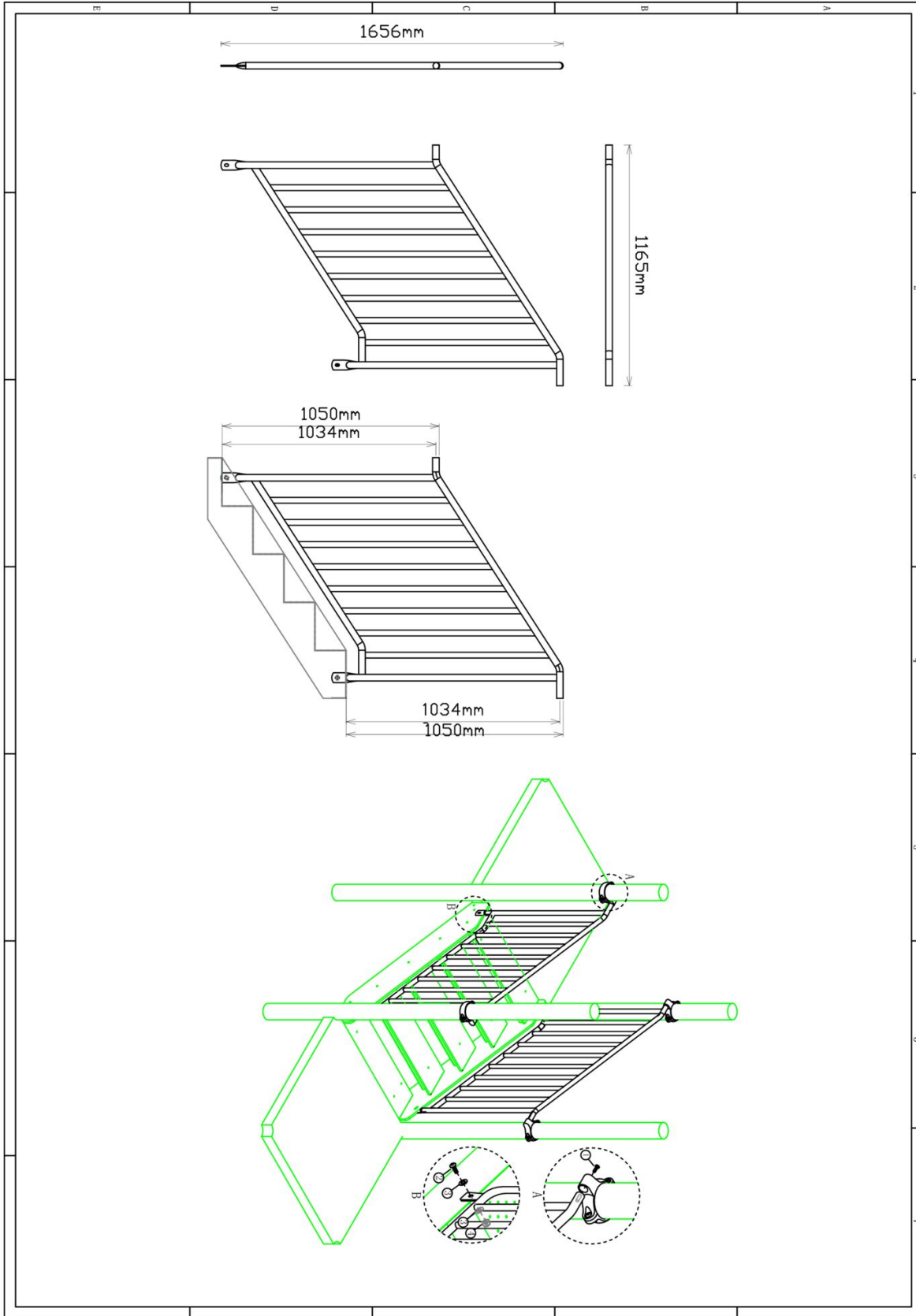

Hoofdafmetingen: 166x116,5cm



60cm tussentrap railing HPL (per 2stuks)

STAP 1 van 1

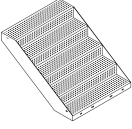
Omschrijving: Bevestiging van de railing aan de paal en trap

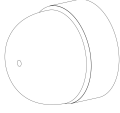
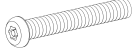
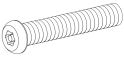
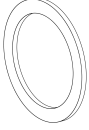
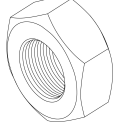
1 st. 60cm tussen-trap	4 st. Ring	4 st. Afdekdop M10	4 st. Torx M8X30
			
4 st. Torx M10X25	8 st. Ring M10 (groot)	4 st. Lock Moer M10	
			

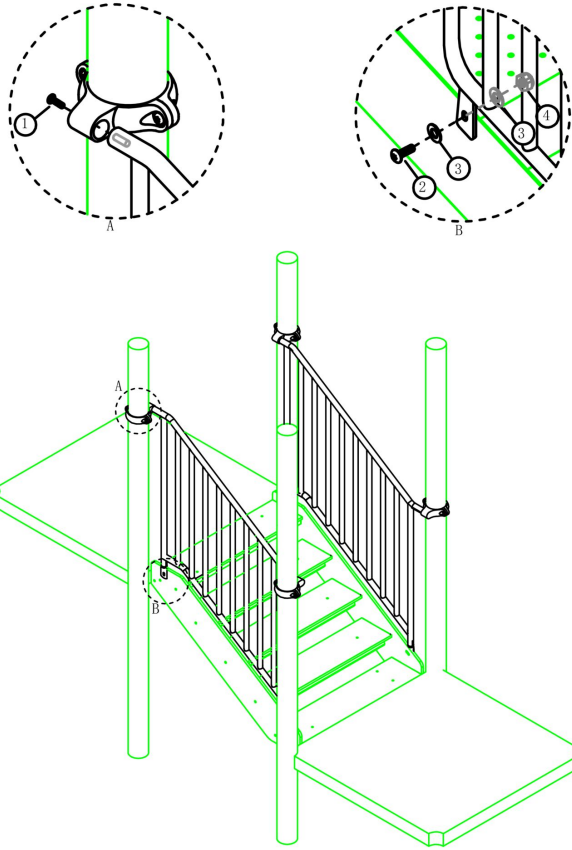

Bevestigings materiaal is per zakje verpakt en bovenstaande afbeelding zit in het zakje

Balustrade metaal



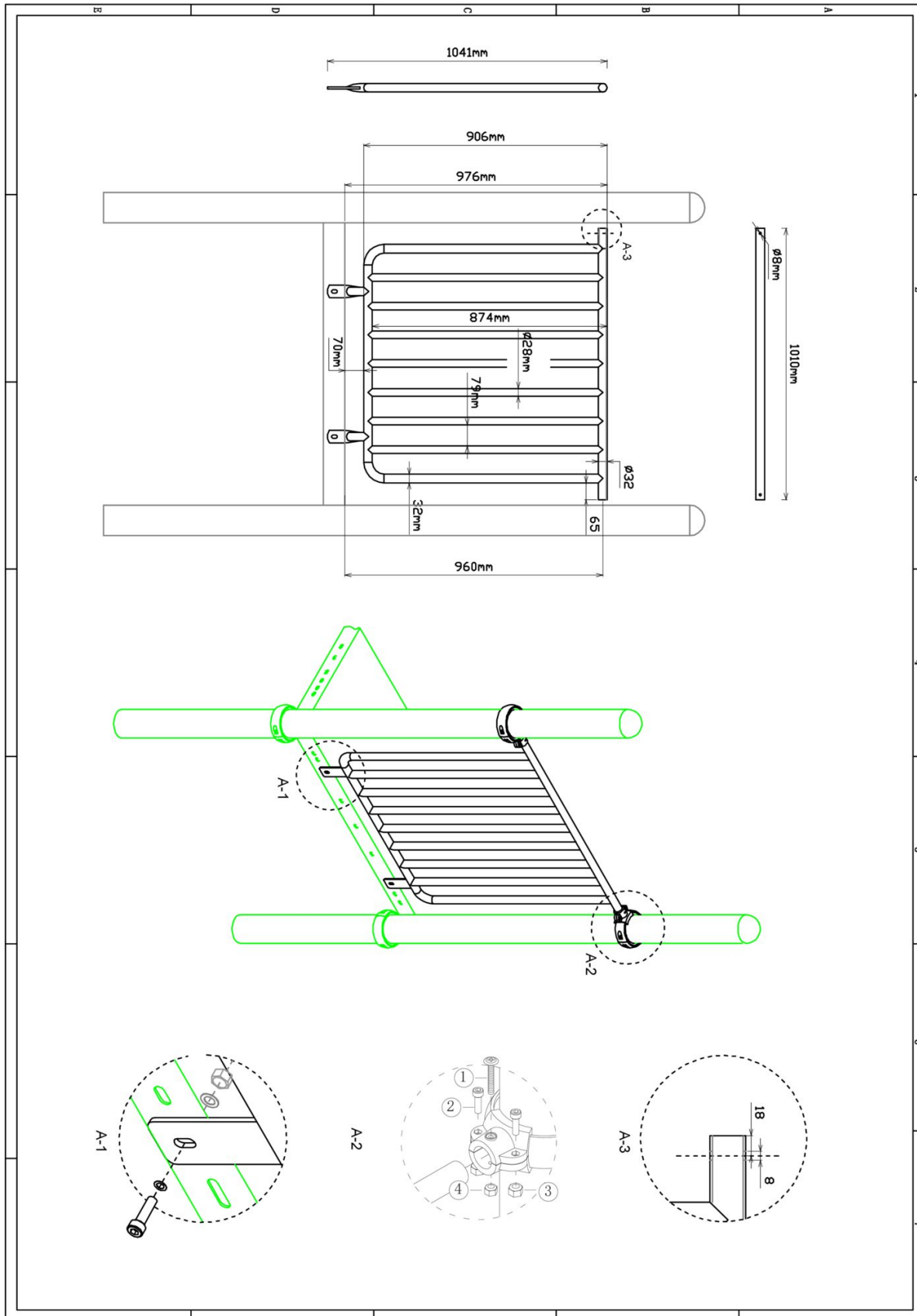



Hoofdafmetingen: 105x101cm

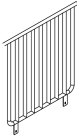

Balustrade metaal

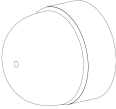
STAP 1 van 1

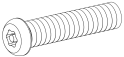
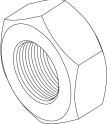
Omschrijving: Bevestiging tussen de vloer/staander

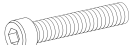
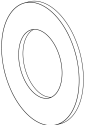
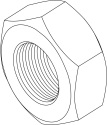
1 st. Balustrade metaal	2 st. Small clamp + ring	2 st. Afdekdop M10	2 st. Kruiskop M6X65
			① 
4 st. Torx M8X20	4 st. Lock Moer M8	2 st. Lock Moer M6	2 st. Bout M10X25
② 	③ 	④ 	⑤ 
4 st. Ring M10 (middel)	2 st. Lock Moer M10		
⑥ 	⑦ 		

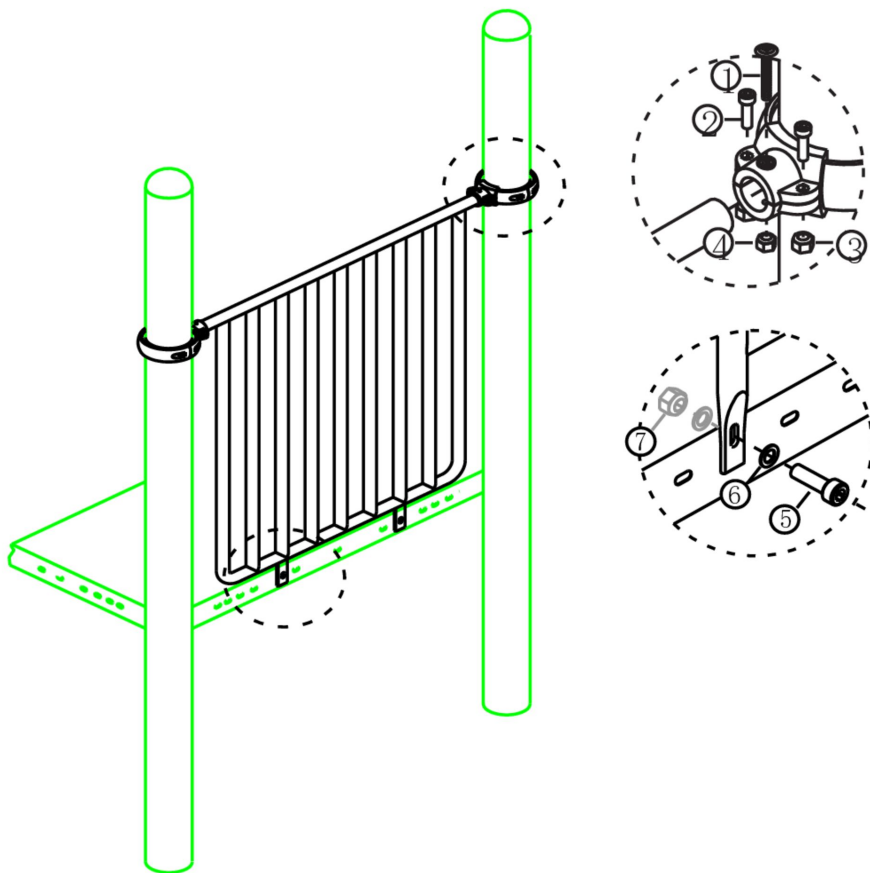

Bevestigings materiaal is per zakje verpakt en bovenstaande afbeelding zit in het zakje

Hekje tbv glijstang



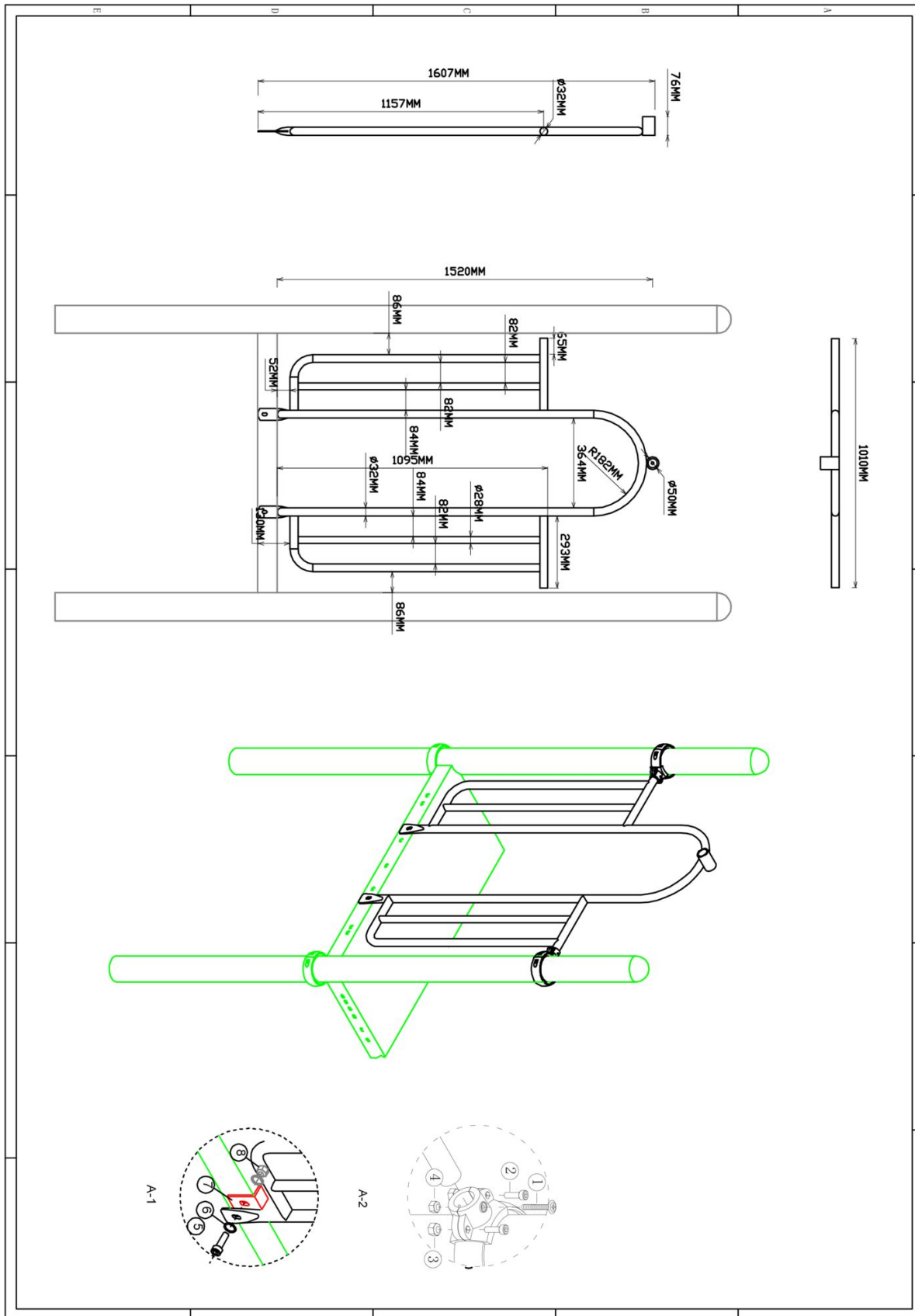





Hoofdafmetingen: 152x101cm

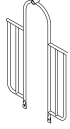

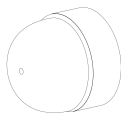
Hekje tbv glijstang

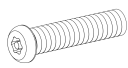
STAP 1 van 1

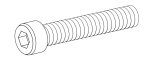
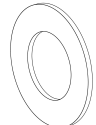
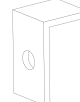
Omschrijving: Bevestiging van het hek tussen de vloer/staander

1 st. Hekje tbv glijstang	2 st. Small clamp + ring	2 st. Afdekdop M10	2 st. Kruiskop M6X65
			
4 st. Torx M8X20	4 st. Lock Moer M8	2 st. Lock Moer M6	2 st. Bout M10X25
			
4 st. Ring M10 (middel)	2 st. Hoekje	2 st. Lock Moer M10	
			

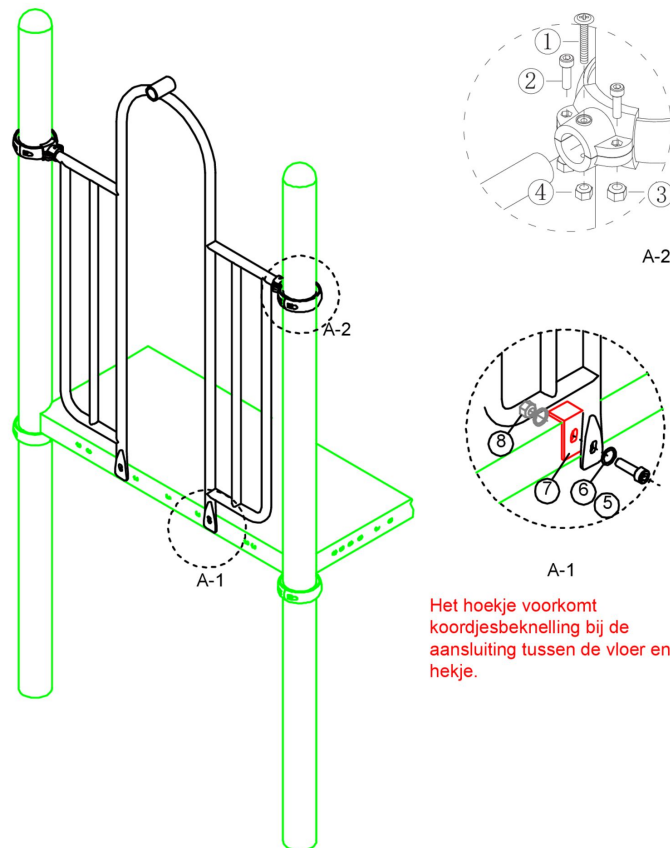

Het hoekje voorkomt koordjesbeknelling bij de aansluiting tussen de vloer en het hekje.

Bevestigings materiaal is per zakje verpakt en bovenstaande afbeelding zit in het zakje

150cm Glijstang

Hoofdafmetingen: 362x42cm

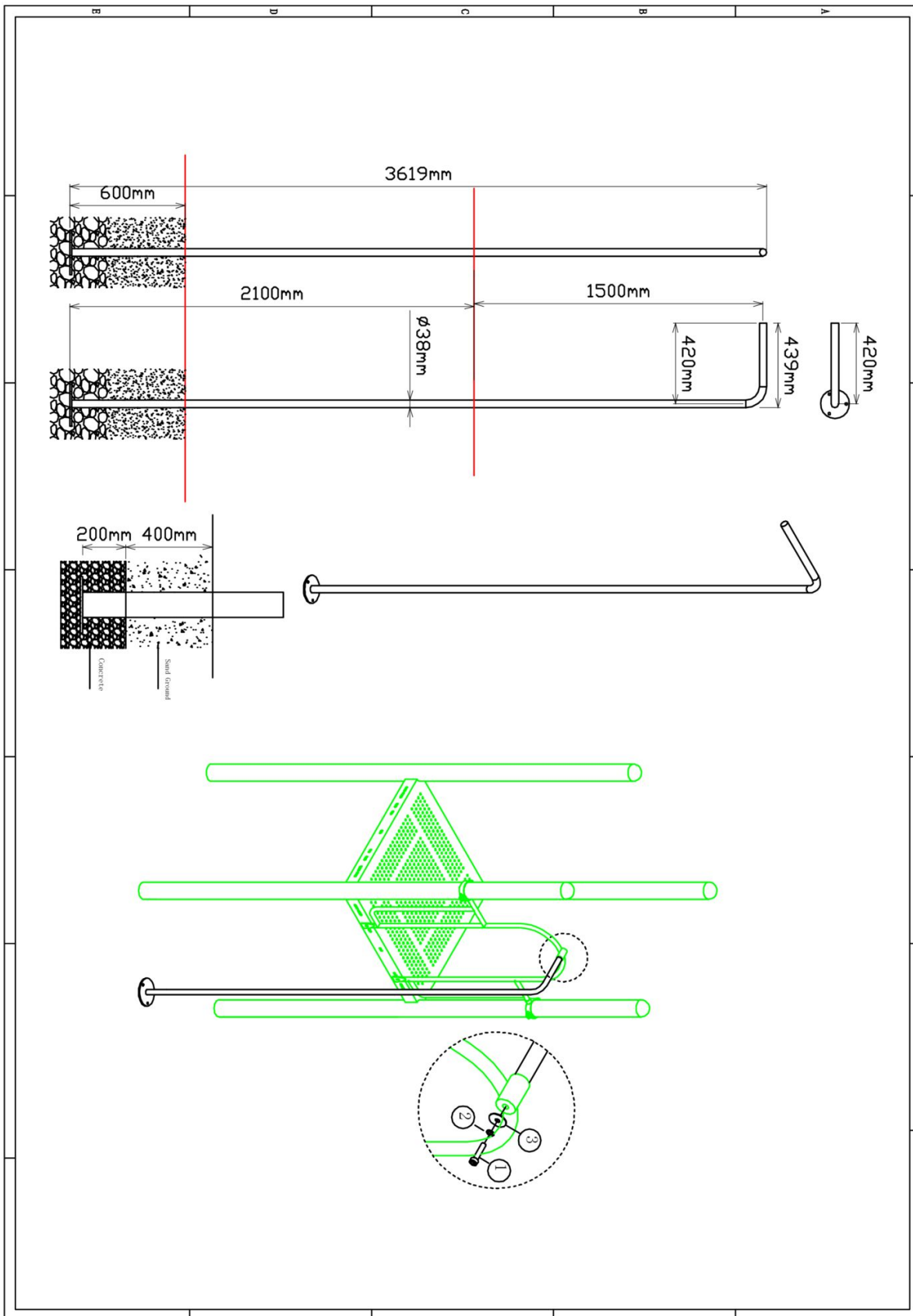

150cm Glijstang

STAP 1 van 1

Omschrijving: Bevestiging tussen de glijstang en het hek

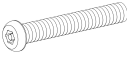
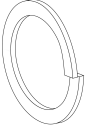
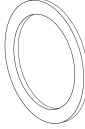
1 st. 150cm Glijstang	1 st. Torx M10X30	1 st. Veerring M10	1 st. Ring M10 (groot)
			

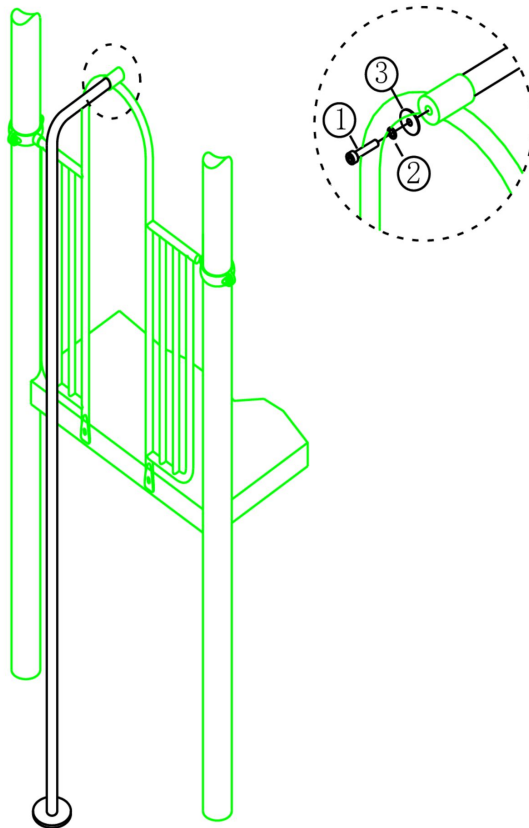



Bevestigings materiaal is per zakje verpakt en bovenstaande afbeelding zit in het zakje

Hekje tbv Snake climber

STAP 1 van 1

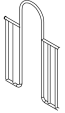
Omschrijving: Bevestiging van het paneel tussen de staanders

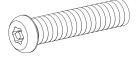
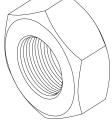
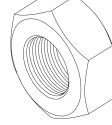
1 st. Hekje tbv Snake climber	4 st. Small clamp + ring	4 st. Kruiskop M6X65	8 st. Torx M8X20
		1 	2 
8 st. Lock Moer M8	4 st. Lock Moer M6		
3 	4 		

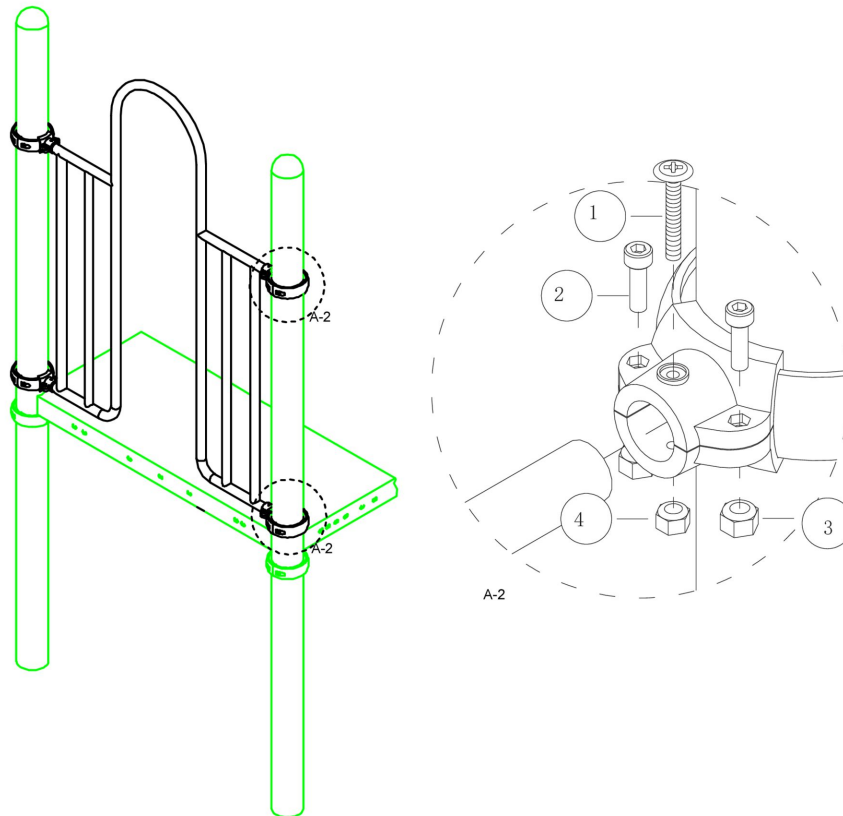

Bevestigings materiaal is per zakje verpakt en bovenstaande afbeelding zit in het zakje

150cm Snake climber

Hoofdafmetingen: 209x67cm

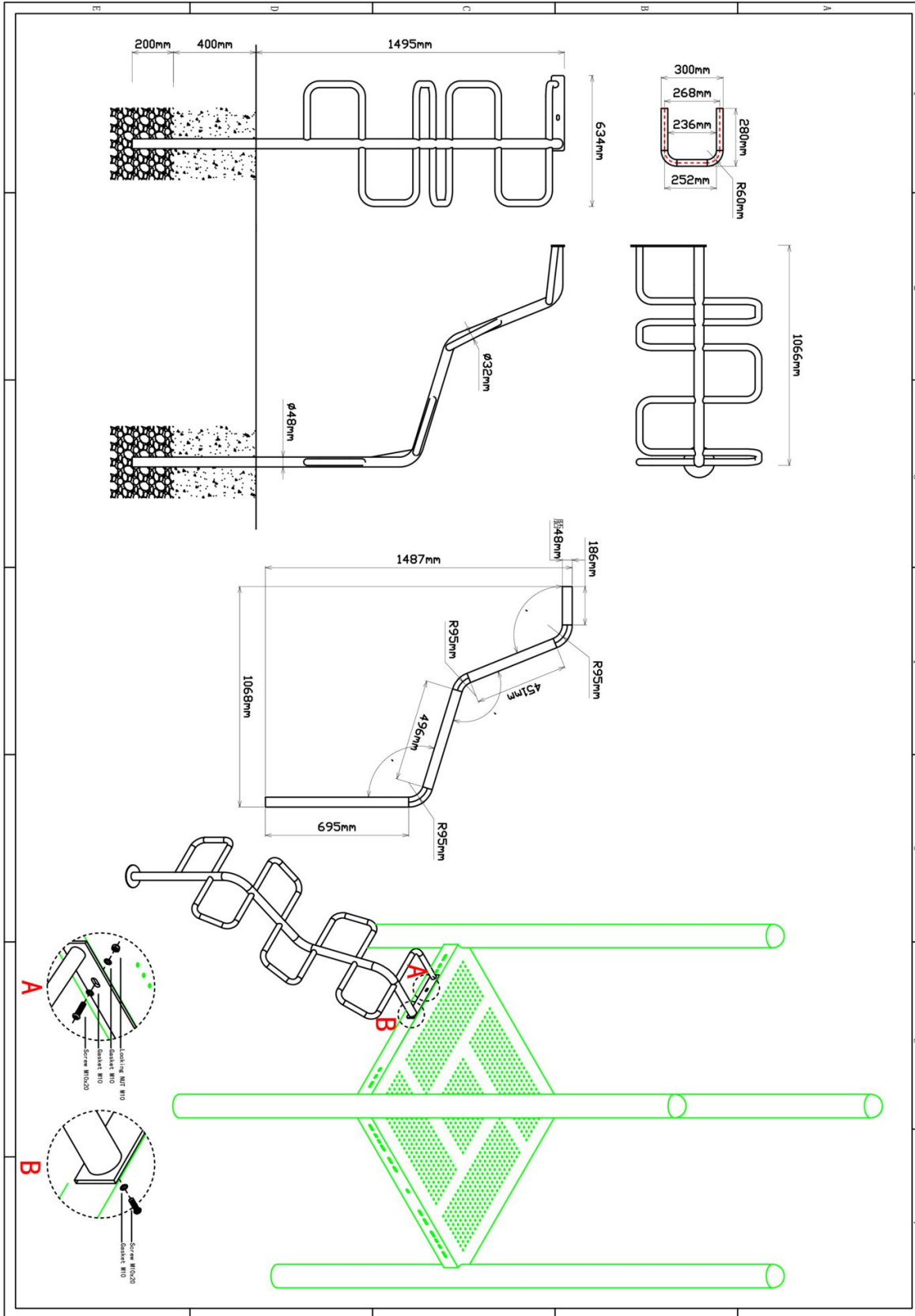

150cm Snake climber

STAP 1 van 1

Omschrijving: Bevestiging tussen snake climber en de vloer

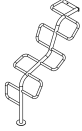
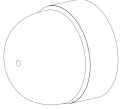
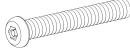
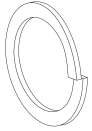
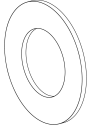
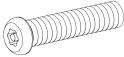
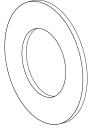
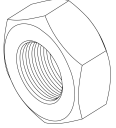
1 st. 150cm Snake climber	1 st. Afdekdop M10	1 st. Torx M10X30	1 st. Veerring M10
		1 	2 
1 st. Ring M10 (middel)	1 st. Torx M10X20	2 st. Ring M10 (middel)	1 st. Lock Moer M10
3 	4 	5 	6 

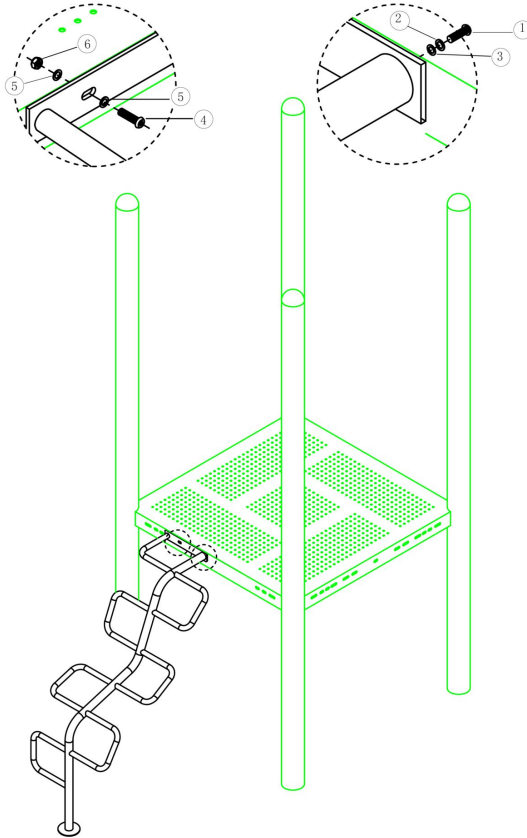

Bevestigings materiaal is per zakje verpakt en bovenstaande afbeelding zit in het zakje

90cm trap HPL

Hoofdafmetingen: 101x64x19cm

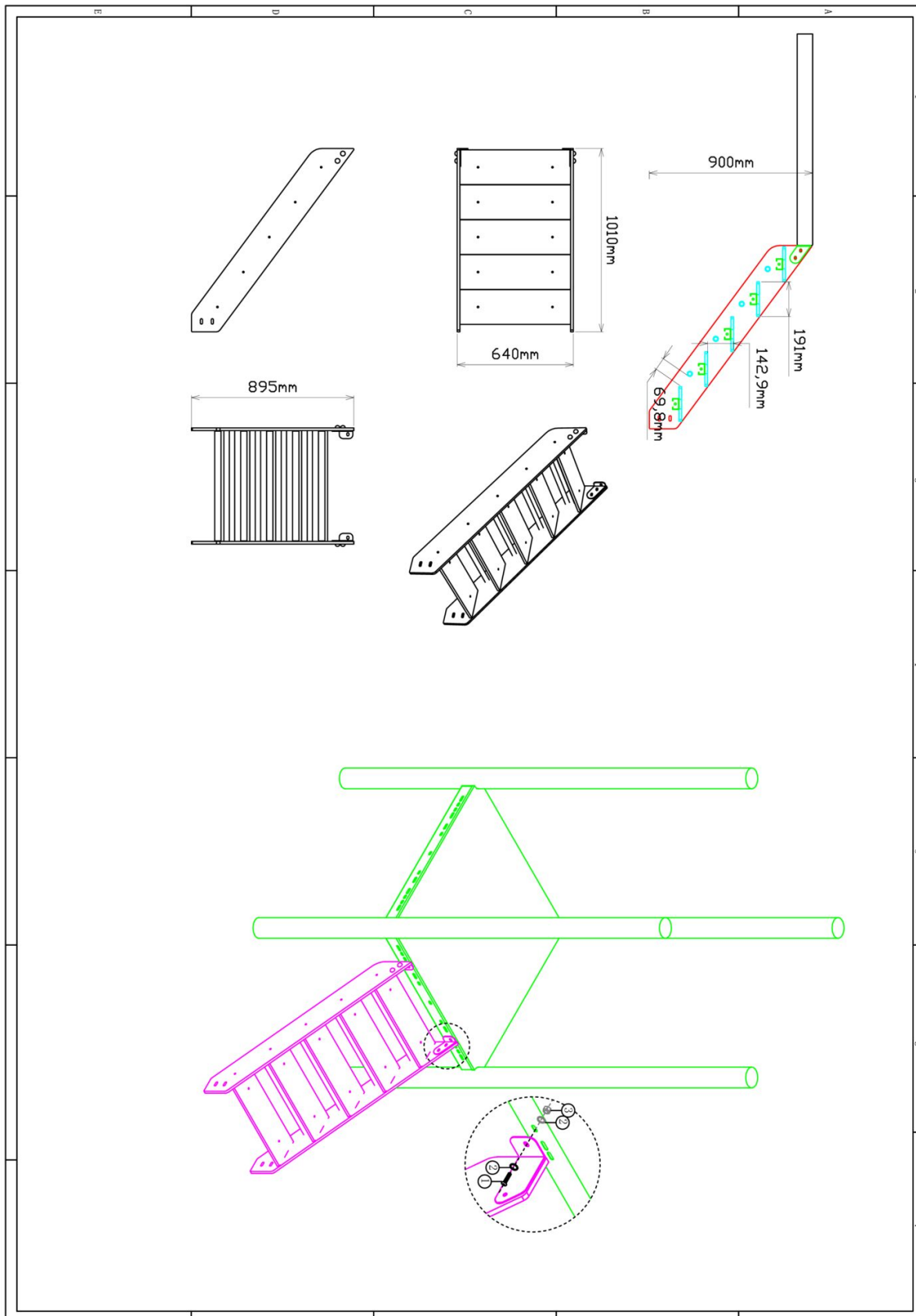

90cm trap HPL

STAP 1 van 1

Omschrijving: Bevestiging van de trap aan de vloer

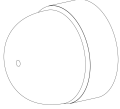
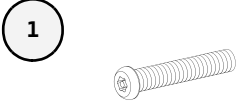
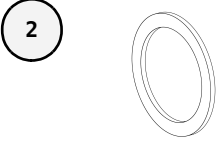
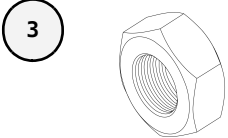
1 st. 90cm trap HPL	3 st. Afdekdop M10	3 st. Torx M10X25	6 st. Ring M10 (groot)
			
3 st. Lock Moer M10			
			

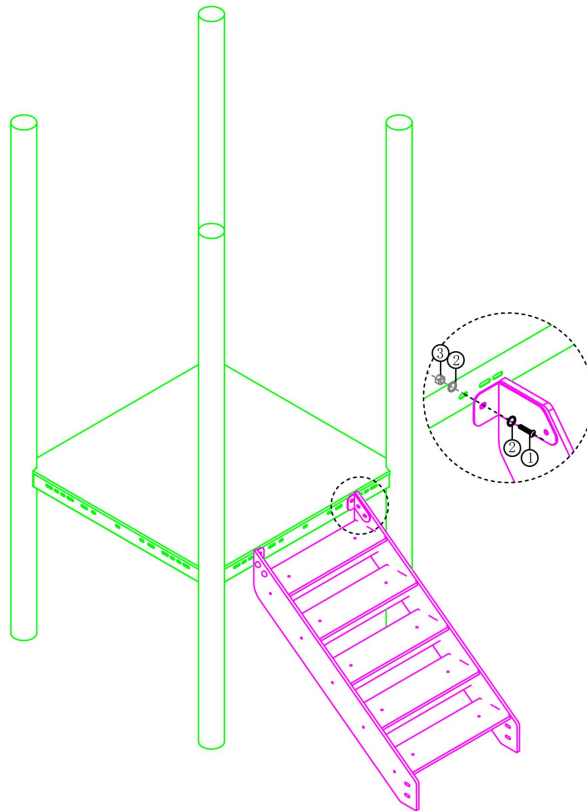

Bevestigings materiaal is per zakje verpakt en bovenstaande afbeelding zit in het zakje

90cm trapleuningen HPL (2 stuks)



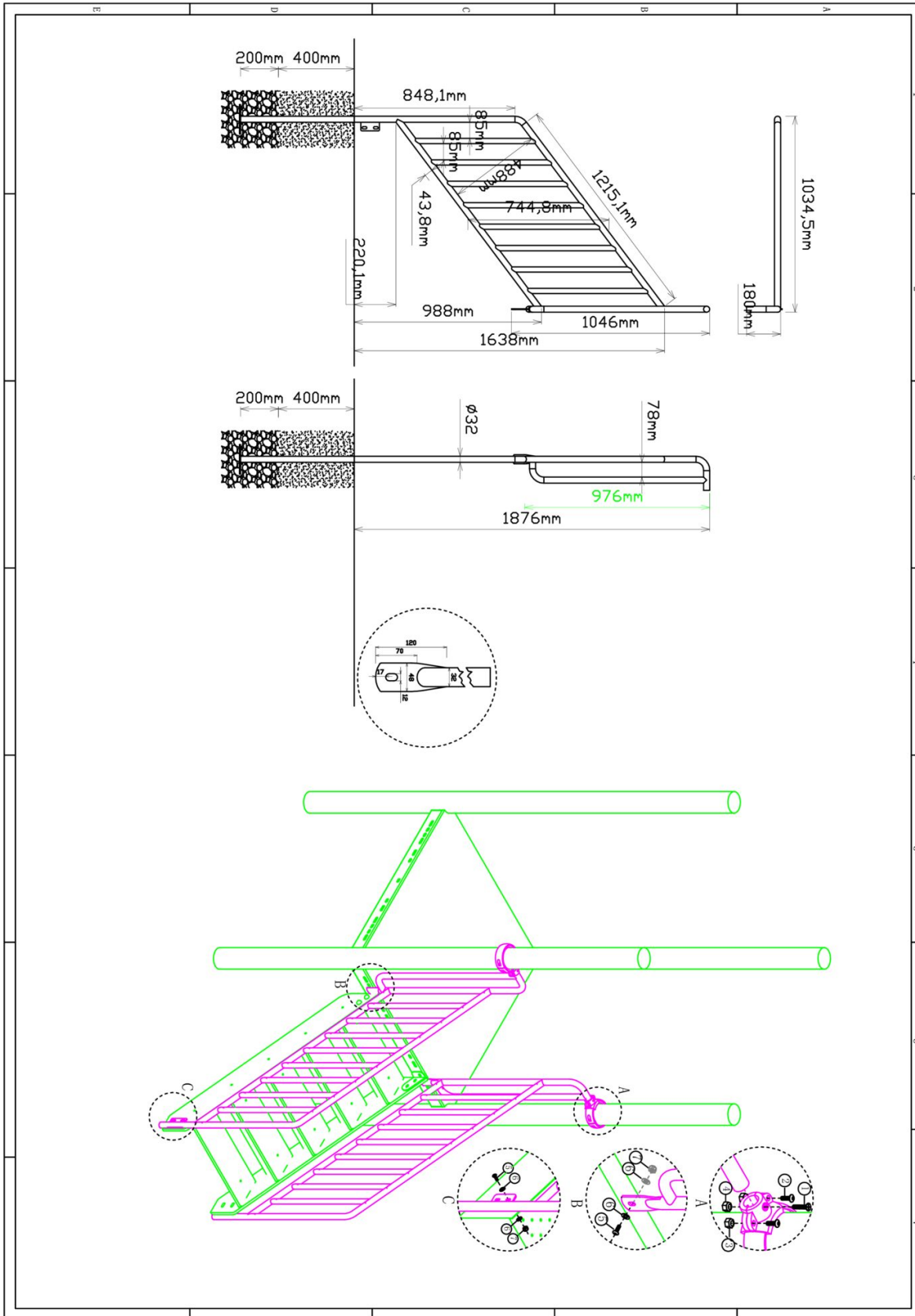



Hoofdafmetingen: 248x103x18cm

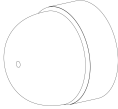

90cm trapleuningen HPL (2 stuks)

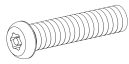
STAP 1 van 1

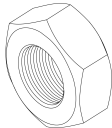
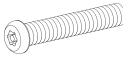
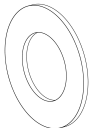
Omschrijving: Bevestiging van de trapleuning aan de vloer, staander en de trap

2 st. Small clamp + ring	6 st. Afdekdop M10	2 st. Kruiskop M6X65	4 st. Torx M8X20
		① 	② 
4 st. Lock Moer M8	2 st. Lock Moer M6	6 st. Torx M10X25	12 st. Ring M10 (middel)
③ 	④ 	⑤ 	⑥ 
6 st. Lock Moer M10			
⑦ 			

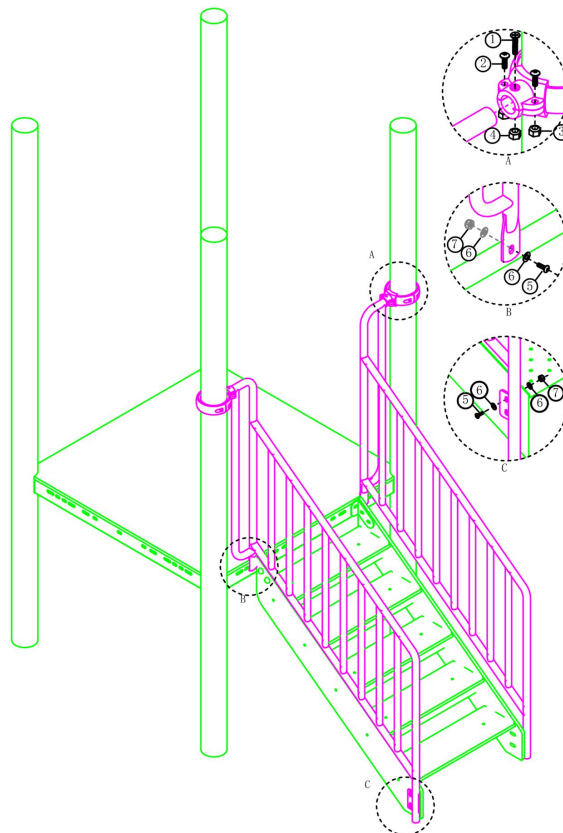







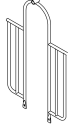

Bevestigings materiaal is per zakje verpakt en bovenstaande afbeelding zit in het zakje

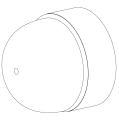
Hekje tbv: B, Pod en Curly Climber

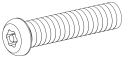
STAP 1 van 1

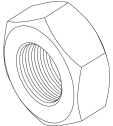
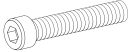
Omschrijving: Bevestiging van het hek tussen de vloer/staander

1 st. Hekje tbv: B, Pod en Curly Climber	2 st. Small clamp + ring	2 st. Afdekdop M10	2 st. Kruiskop M6X65
			① 
4 st. Torx M8X20	4 st. Lock Moer M8	2 st. Lock Moer M6	2 st. Bout M10X25
② 	③ 	④ 	⑤ 
4 st. Ring M10 (middel)	2 st. Lock Moer M10		
⑥ 	⑦ 		

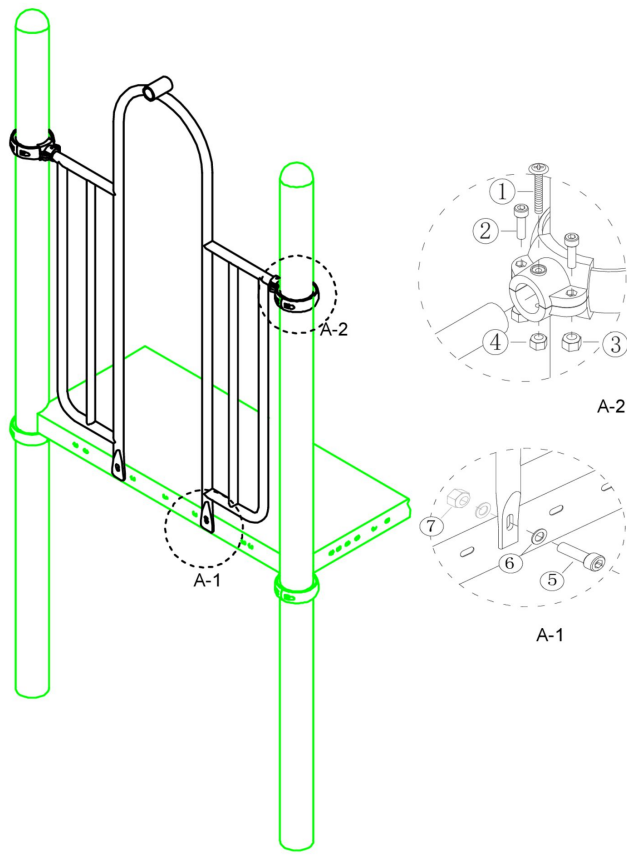

Bevestigings materiaal is per zakje verpakt en bovenstaande afbeelding zit in het zakje

150cm Curly climber

150cm Curly climber

STAP 1 van 1

Omschrijving: Bevestiging tussen Curly climber en hek

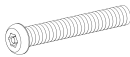
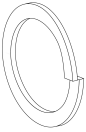
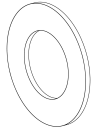
1 st. 150cm Curly climber	1 st. Torx M10X30	1 st. Veerring M10	1 st. Ring M10 (middel)
			

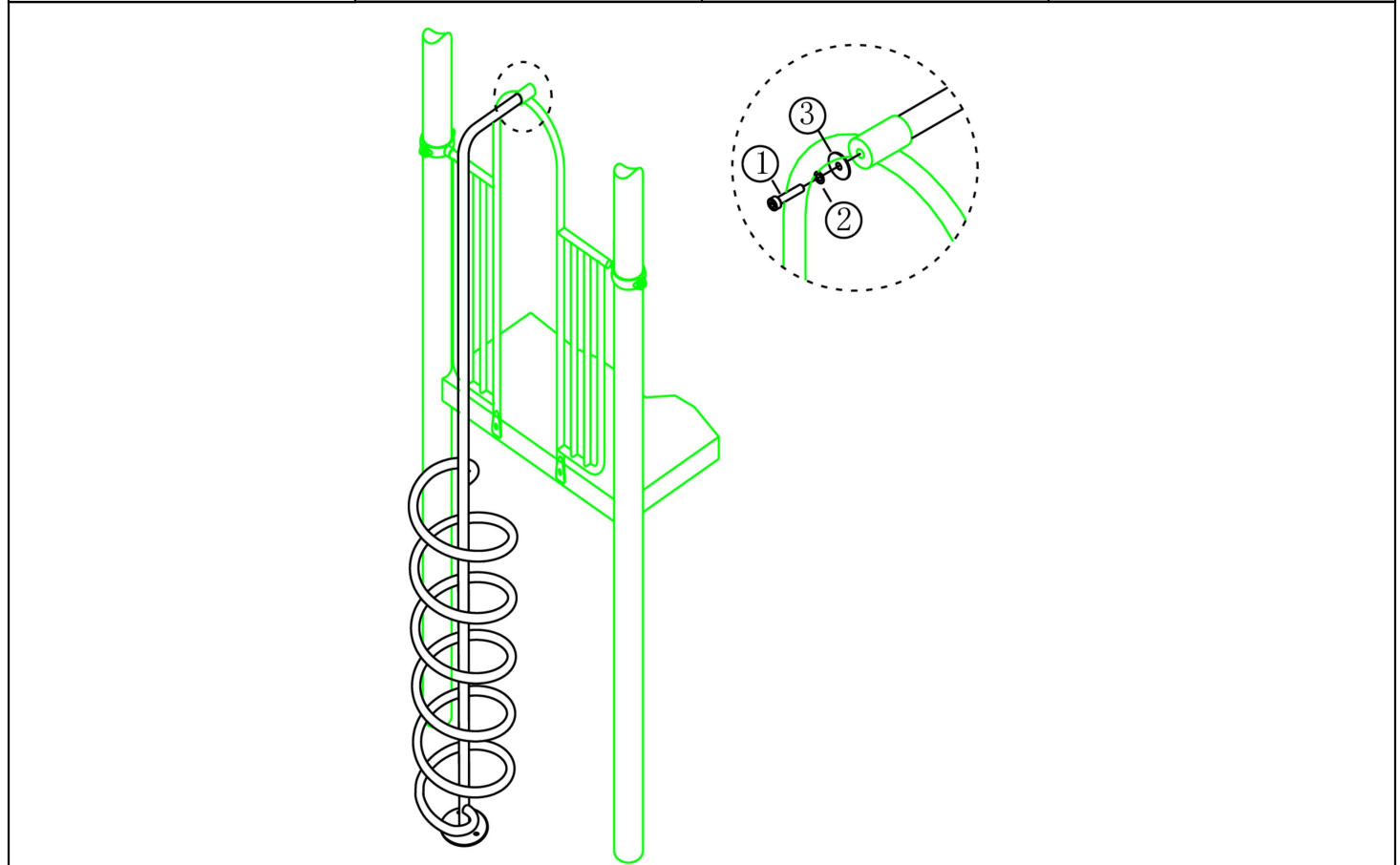





Bevestigings materiaal is per zakje verpakt en bovenstaande afbeelding zit in het zakje

Hek voor RVS glijbaan

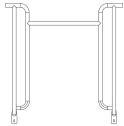
STAP 1 van 1

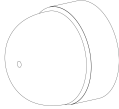
Omschrijving: Bevestiging tussen de vloer/staander en het hekje

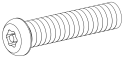
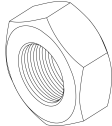
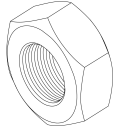
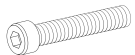
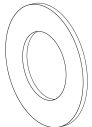
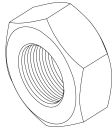
1 st. Hek voor RVS glijbaan	2 st. Small clamp + ring	2 st. Afdekdop M10	2 st. Kruiskop M6X65
			① 
4 st. Torx M8X20	4 st. Lock Moer M8	4 st. Lock Moer M6	2 st. Bout M10X25
② 	③ 	④ 	⑤ 
4 st. Ring M10 (middel)	2 st. Lock Moer M10		
⑥ 	⑦ 		

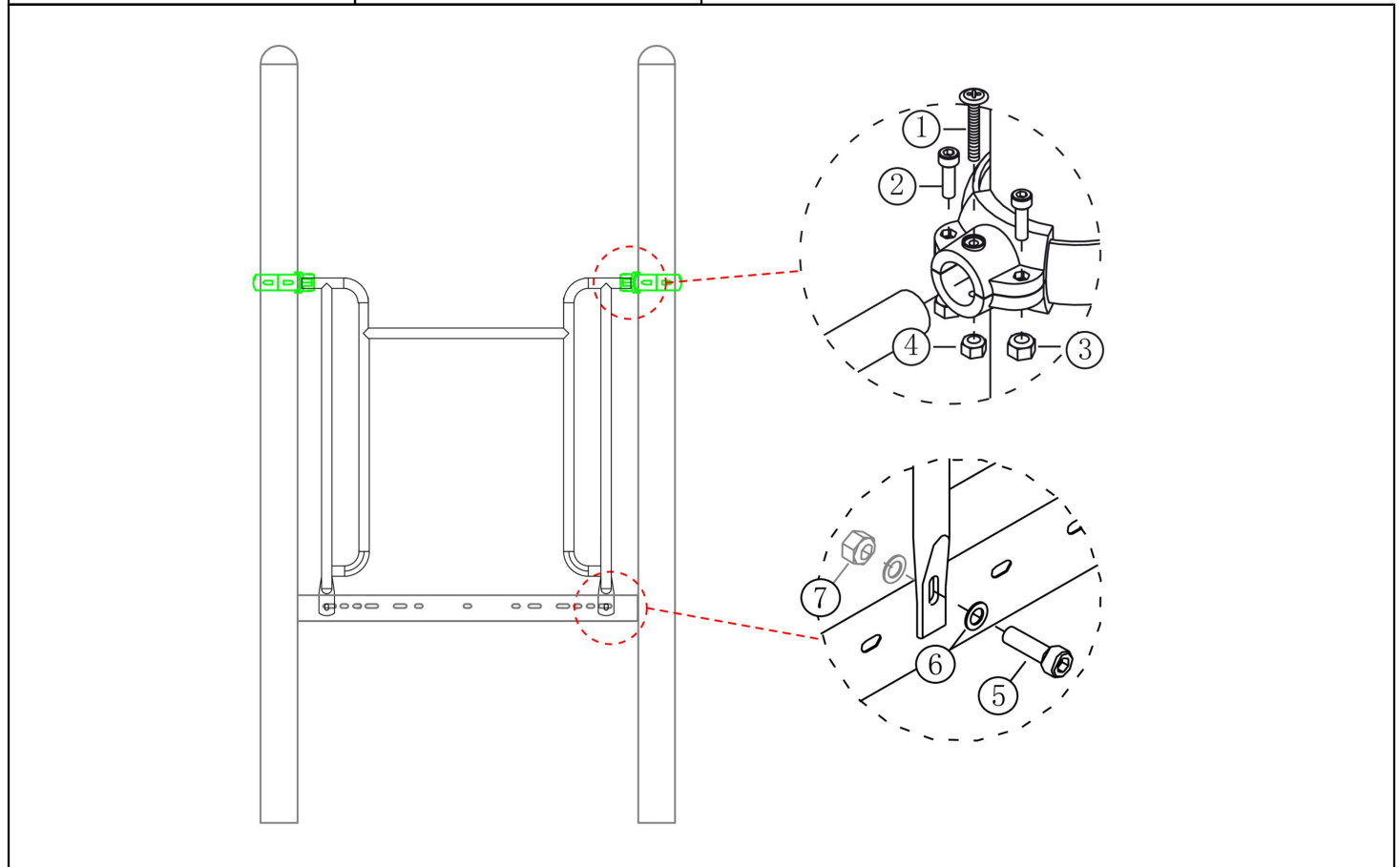

Bevestigings materiaal is per zakje verpakt en bovenstaande afbeelding zit in het zakje

RVS Glijbaan 90cm

Hoofdafmetingen: 179x227x54cm

alle afmetingen zijn in mm.

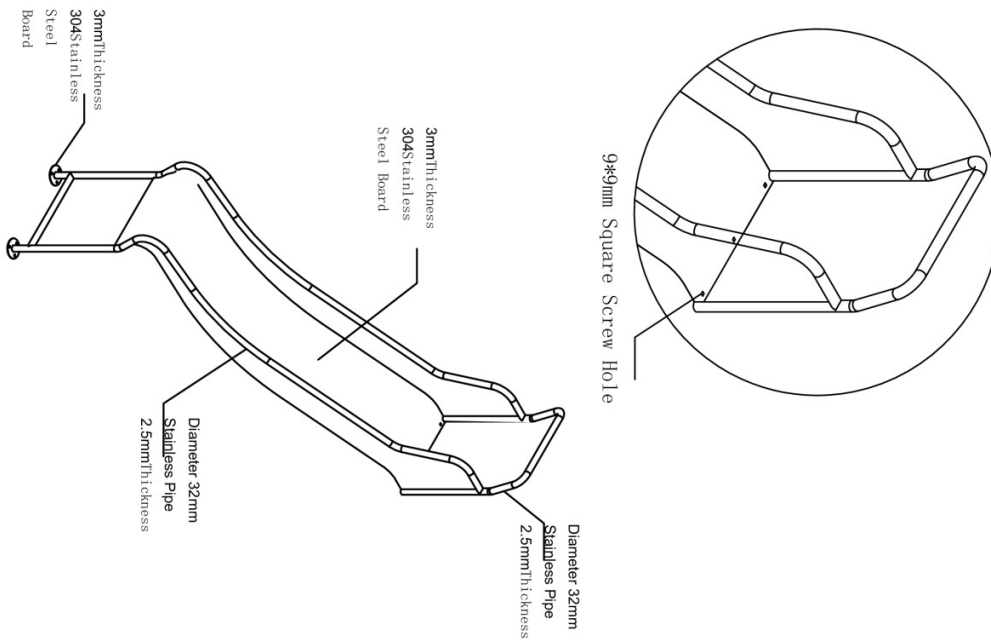
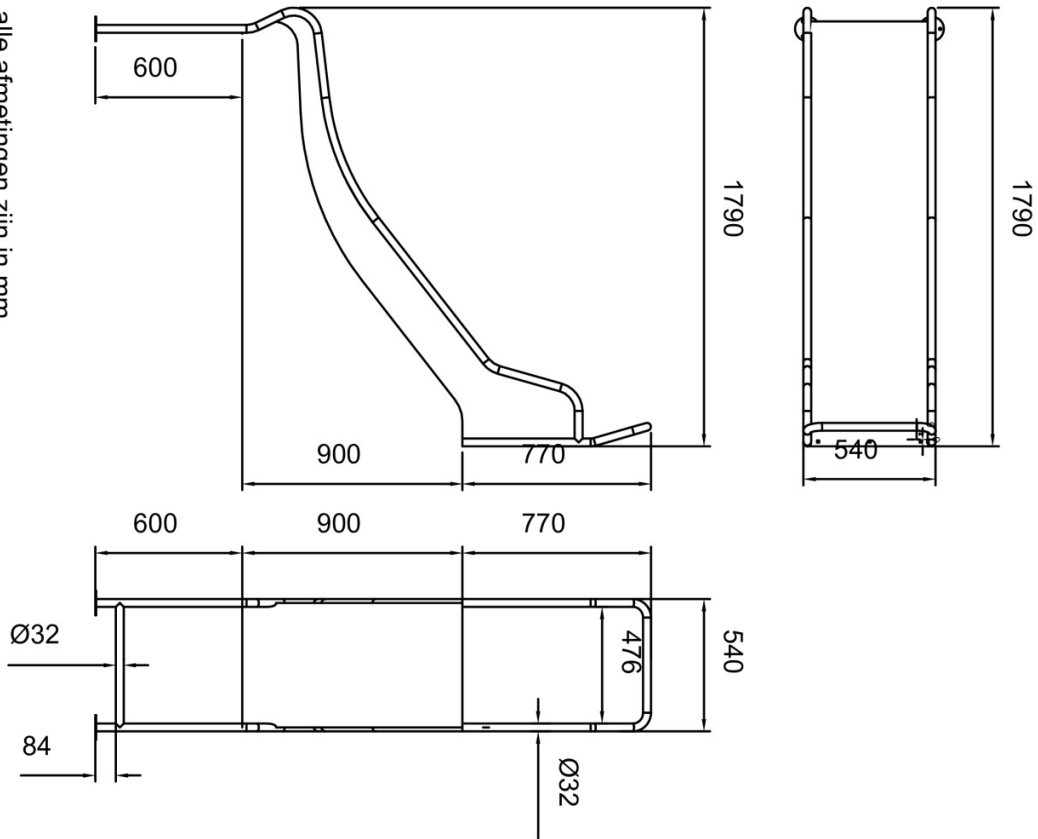



900mm Slide

RVS Glijbaan 90cm

STAP 1 van 2

Omschrijving: Bevestigings gaten in de vloer boren volgens schema

1 st. Boormachine	1 st. Boortje 8,5mm
	

1

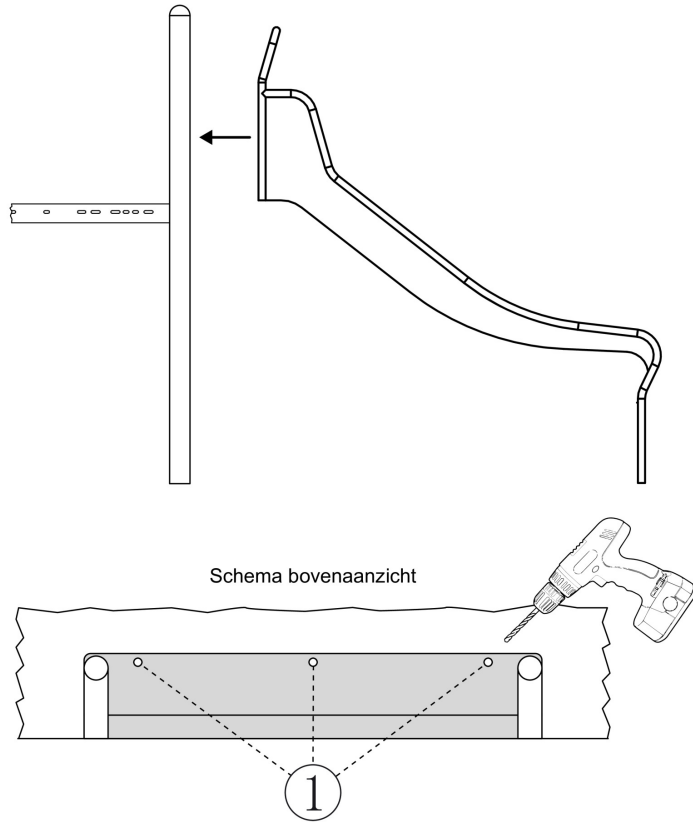

Bevestigings materiaal is per zakje verpakt en bovenstaande afbeelding zit in het zakje

RVS Glijbaan 90cm

STAP 2 van 2

Omschrijving: Glijbaan op de vloer bevestigen met bijgeleverde montagepakket.

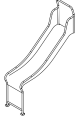
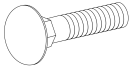
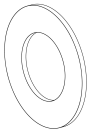
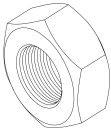
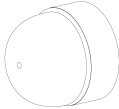
1 st. RVS Glijbaan 90cm	3 st. Slotbout M8X20	
		
3 st. Ring M8 (middel)	3 st. Lock Moer M8	3 st. Afdekdop M8
		

Schema bovenaanzicht

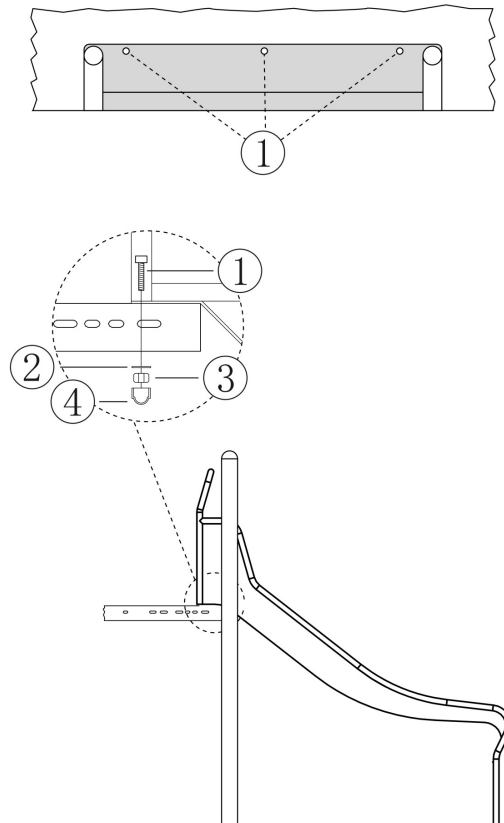

Bevestigings materiaal is per zakje verpakt en bovenstaande afbeelding zit in het zakje

Hek voor RVS glijbaan



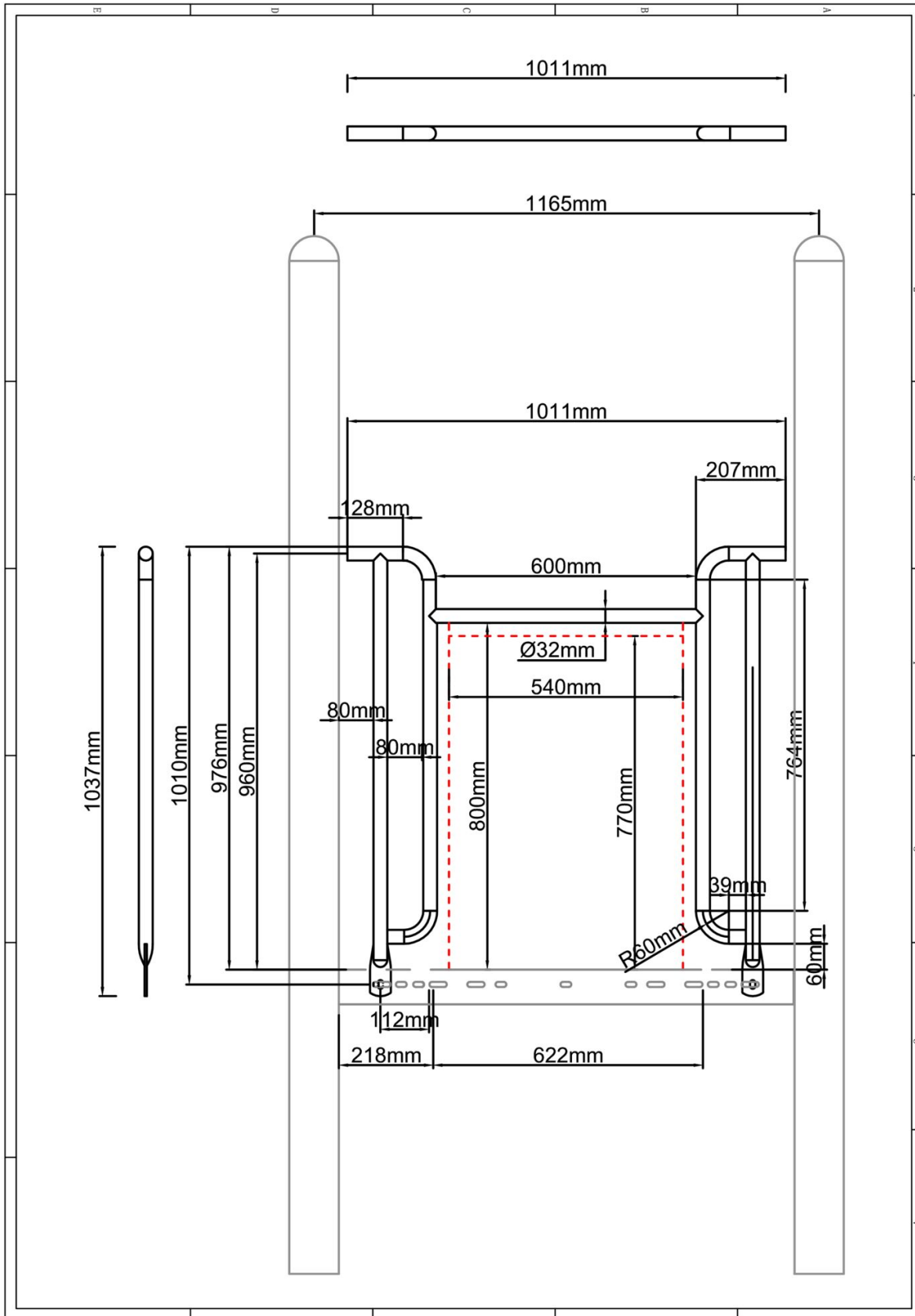

Hoofdafmetingen: 104x101cm

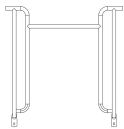

Hek voor RVS glijbaan

STAP 1 van 1

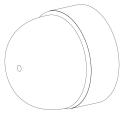
Omschrijving: Bevestiging tussen de vloer/staander en het hekje

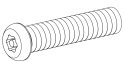
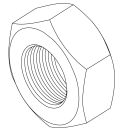
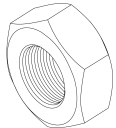
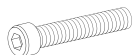
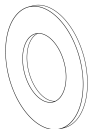
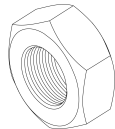
1 st. Hek voor RVS glijbaan	2 st. Small clamp + ring	2 st. Afdekdop M10	2 st. Kruiskop M6X65
			
4 st. Torx M8X20	4 st. Lock Moer M8	4 st. Lock Moer M6	2 st. Bout M10X25
			
4 st. Ring M10 (middel)	2 st. Lock Moer M10		
			

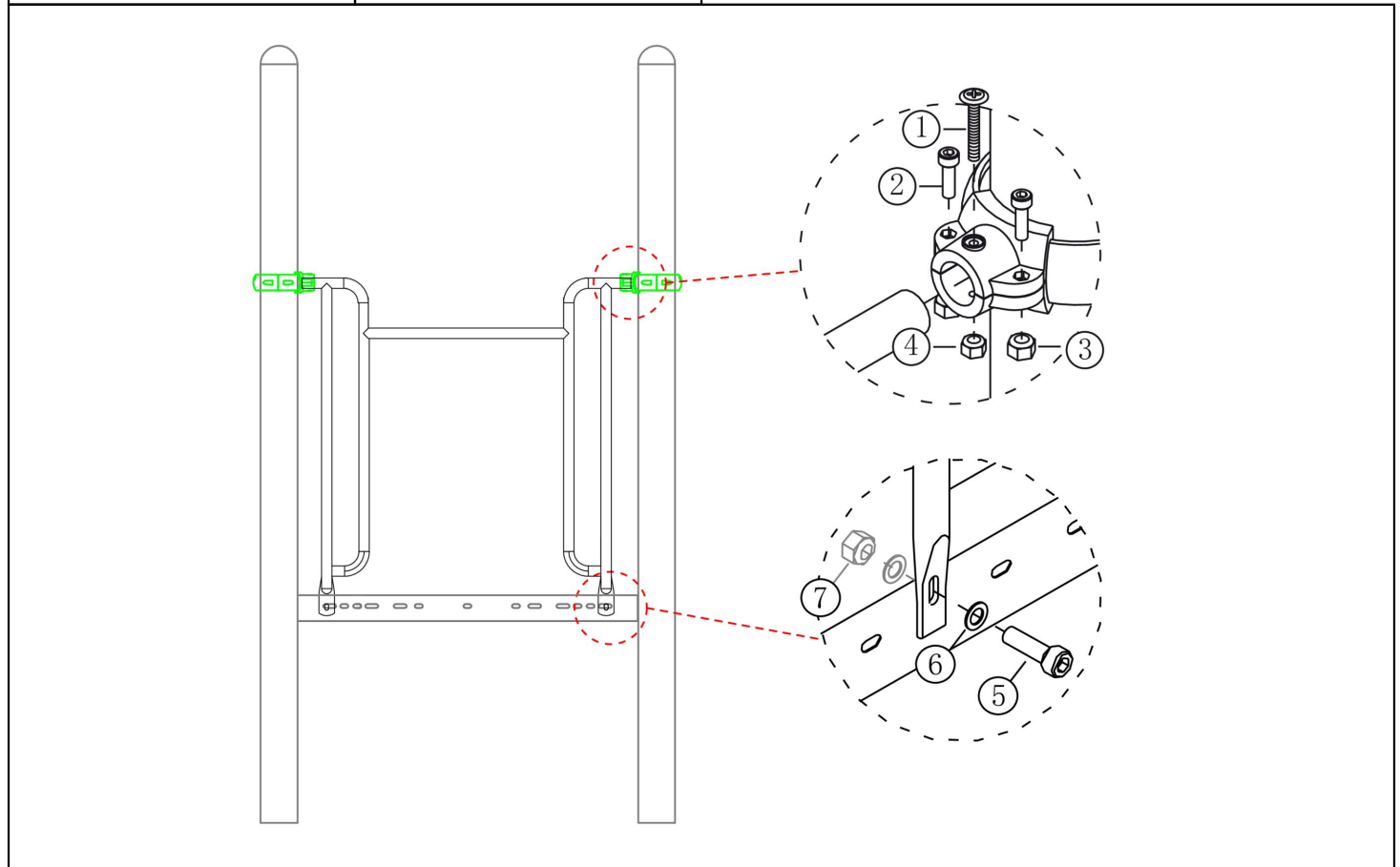

Bevestigings materiaal is per zakje verpakt en bovenstaande afbeelding zit in het zakje

RVS Glijbaan 150cm

Hoofdafmetingen: 250x297x54cm

alle afmetingen zijn in mm.

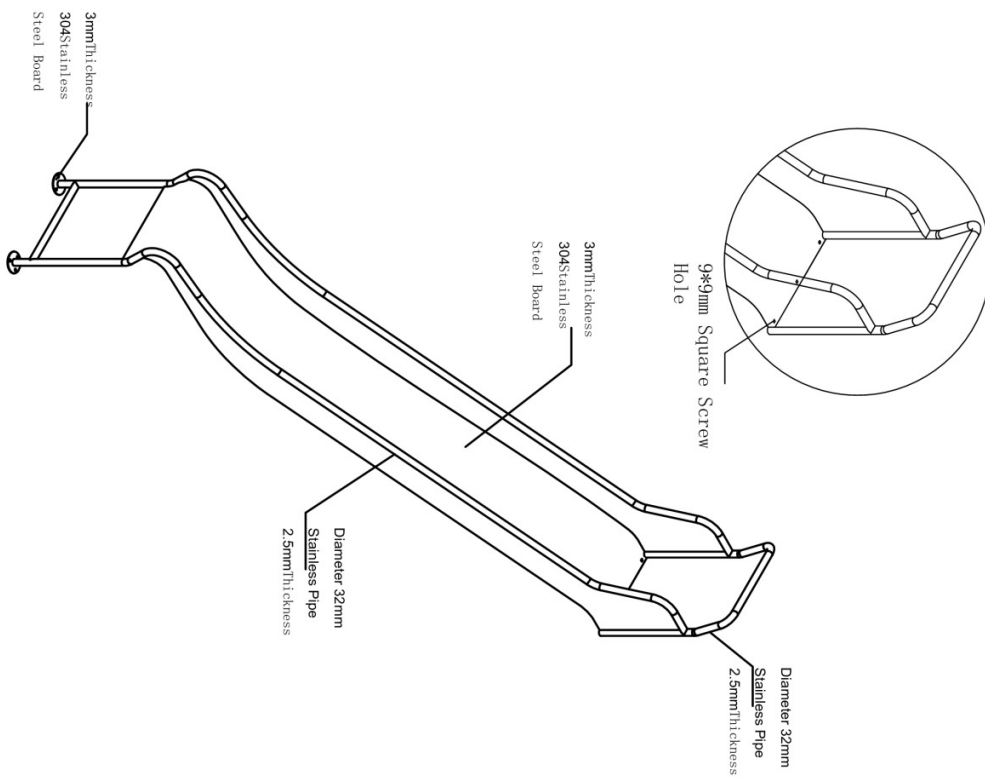
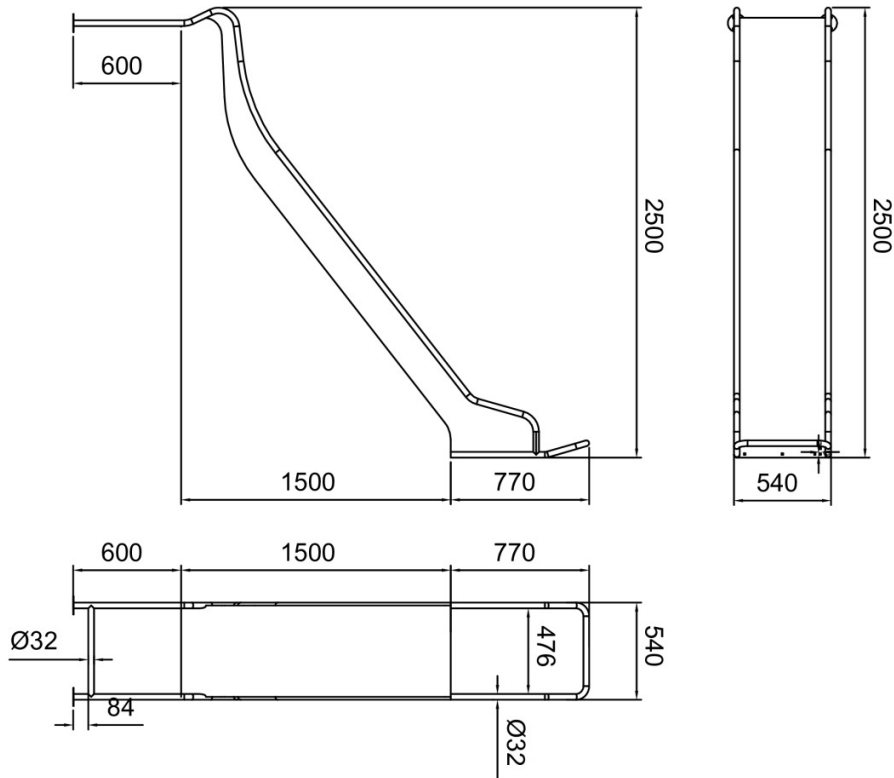

1500mm Slide

RVS Glijbaan 150cm

STAP 1 van 2

Omschrijving: Bevestigings gaten in de vloer boren volgens schema

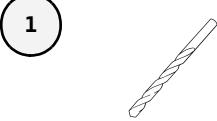
1 st. Boormachine	1 st. Boortje 8,5mm
	

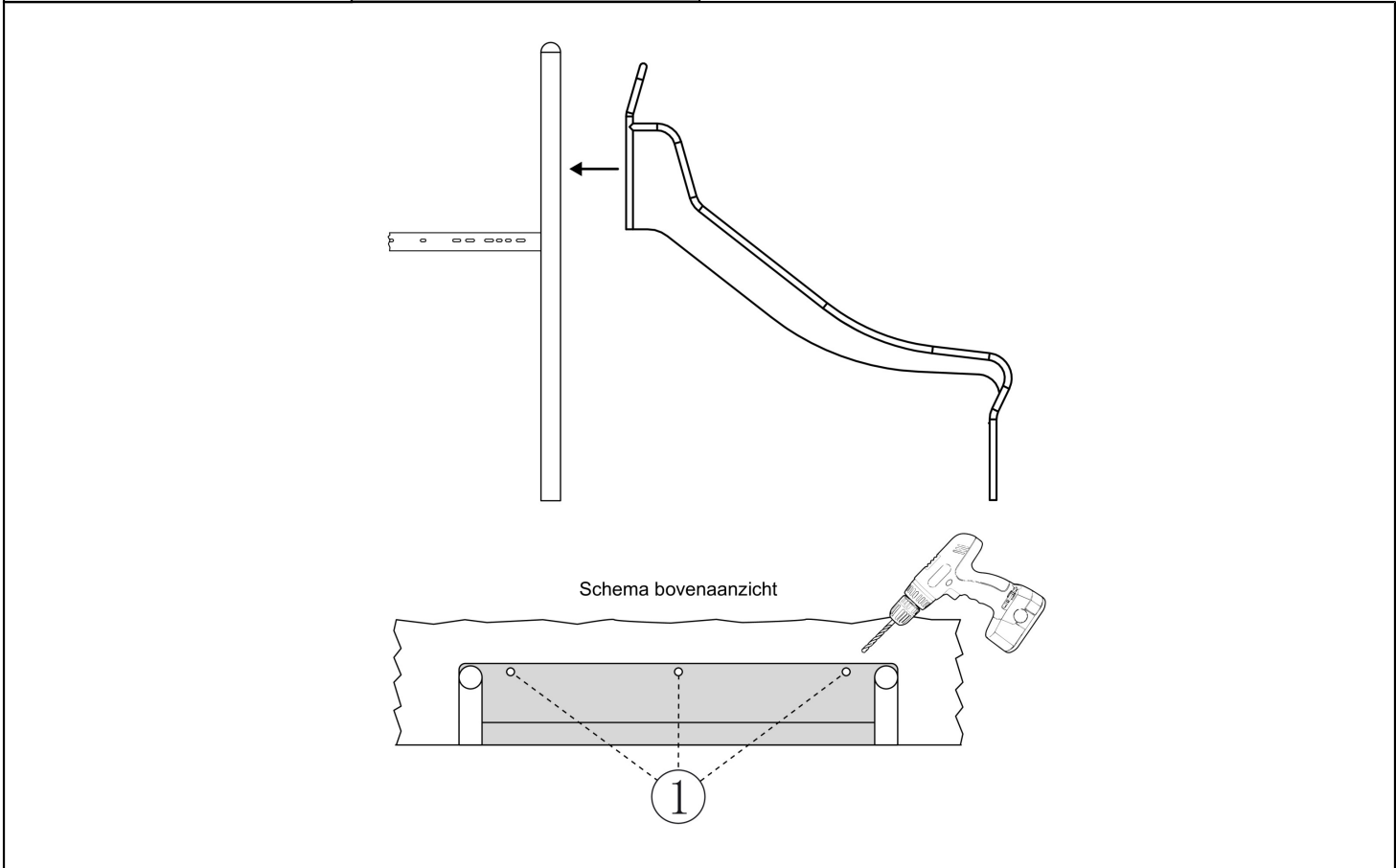

Bevestigings materiaal is per zakje verpakt en bovenstaande afbeelding zit in het zakje

RVS Glijbaan 150cm

STAP 2 van 2

Omschrijving: Glijbaan op de vloer bevestigen met bijgeleverde montagepakket.

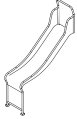
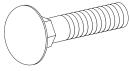
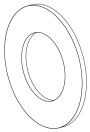
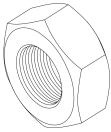
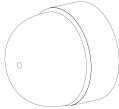
1 st. RVS Glijbaan 90cm	2 st. Slotbout M8X20	
		
2 st. Ring M8 (middel)	2 st. Lock Moer M8	2 st. Afdekdop M8
		

Schema bovenaanzicht

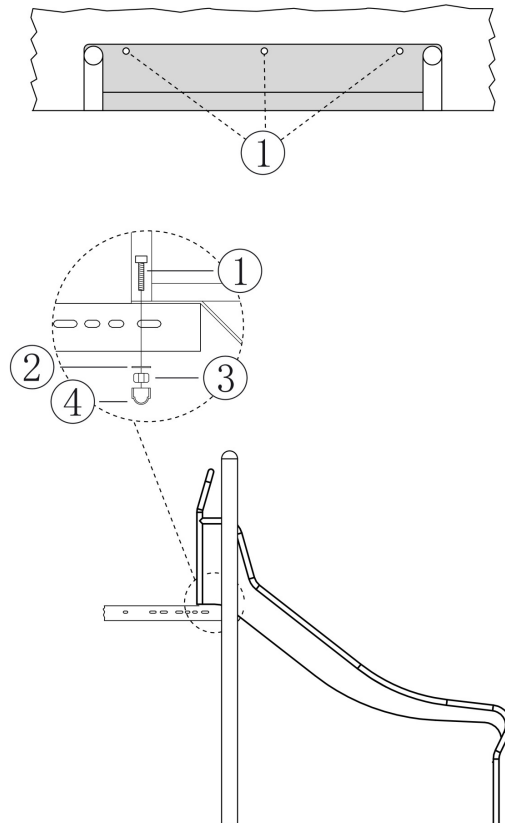

Bevestigings materiaal is per zakje verpakt en bovenstaande afbeelding zit in het zakje

Bankje 2.0

Hoofdafmetingen: 116x22x4cm

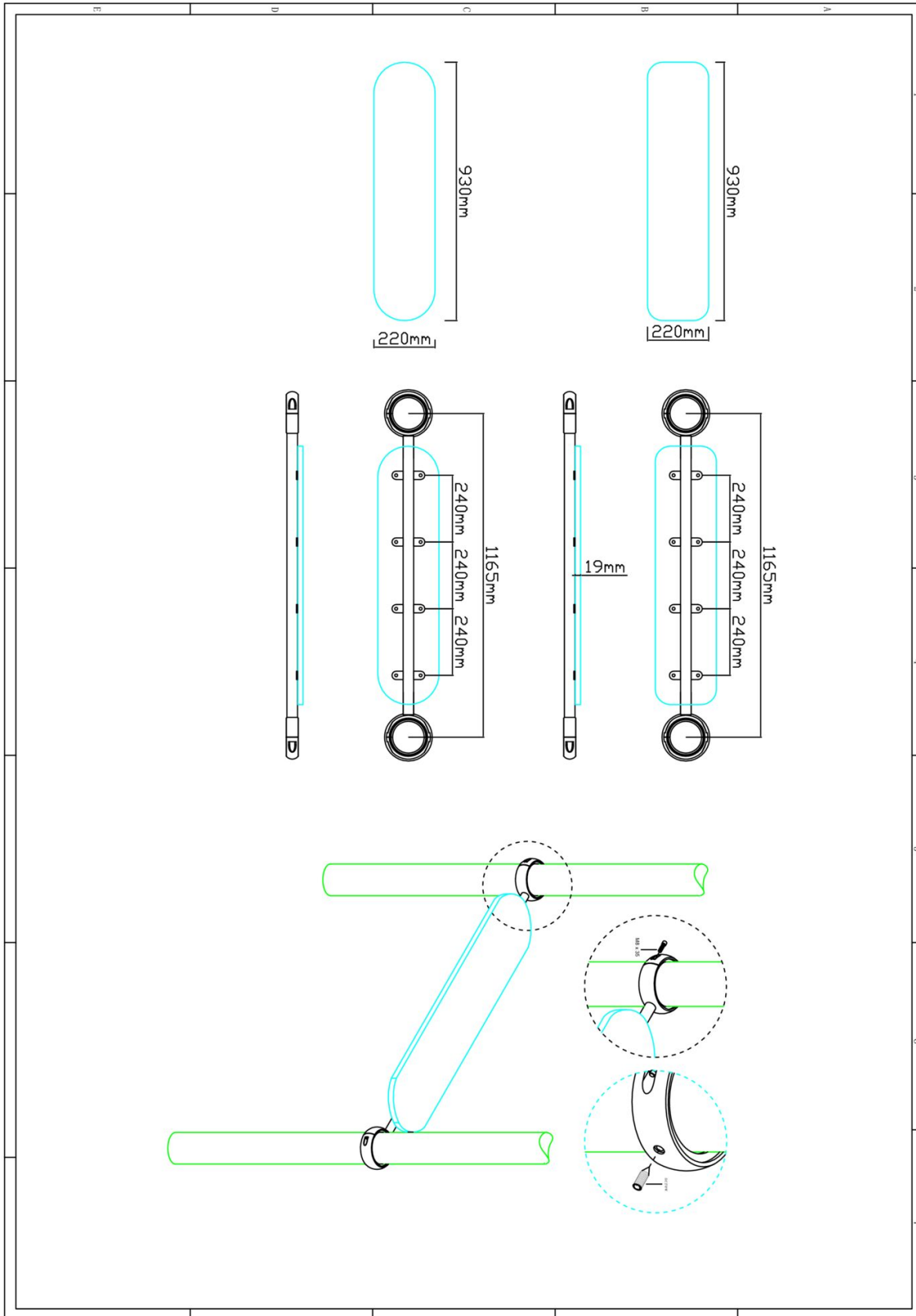

Bankje 2.0

STAP 1 van 1

Omschrijving: Bevestiging tussen de standers en de bank

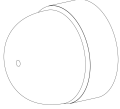
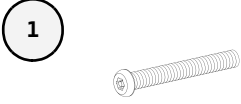
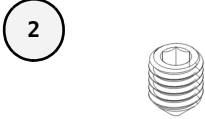
1 st. Bankje 2.0	8 st. Afdekdop M8	4 st. Torx M8X35	2 st. Inbus stelschroef M10x20
			

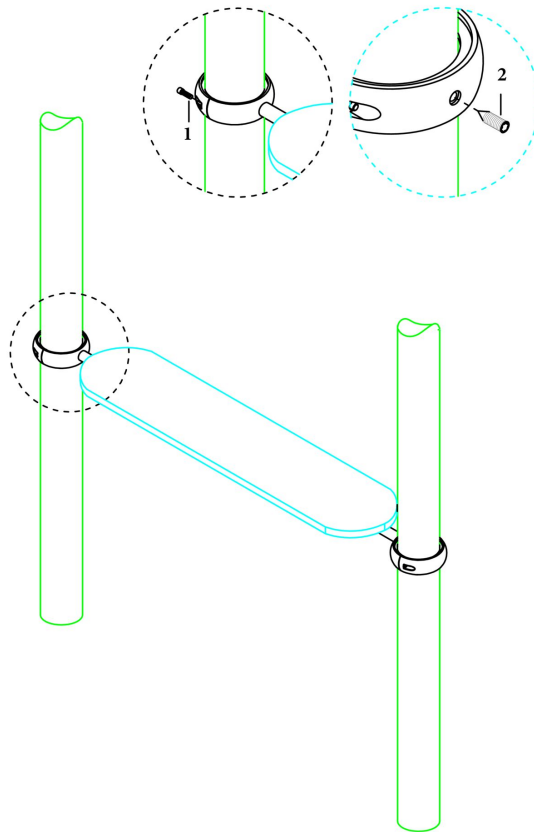

Bevestigings materiaal is per zakje verpakt en bovenstaande afbeelding zit in het zakje

Tussenstap 60cm HPL

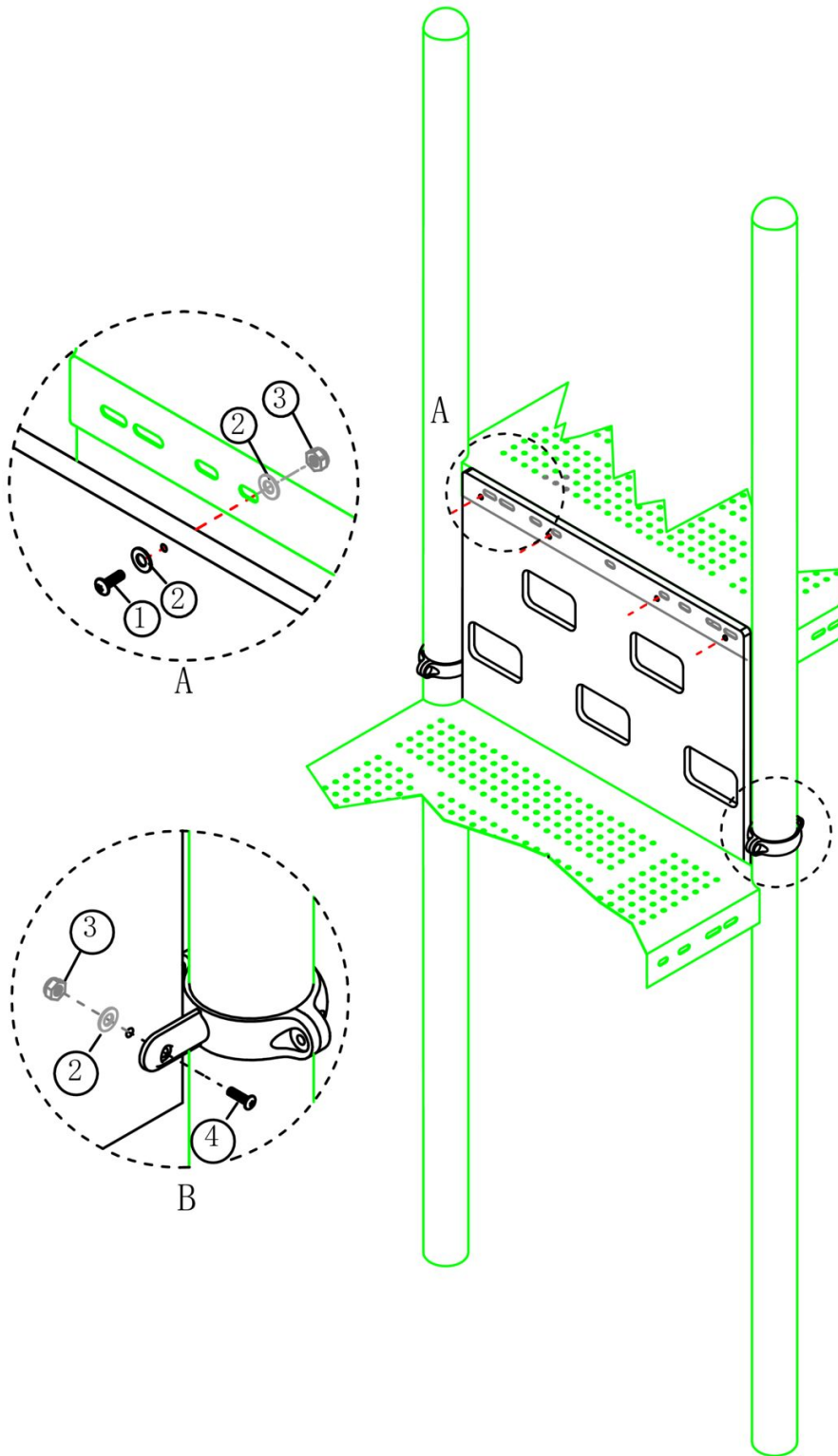

Hoofdafmetingen: 98x30x1,5cm



Tussenstap 60cm HPL

STAP 1 van 1

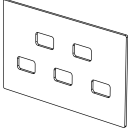
Omschrijving: Bevestiging tussen de tussenstap en de vloeren

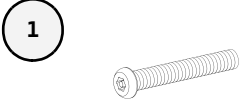
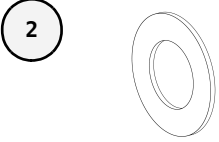
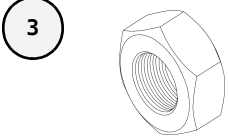
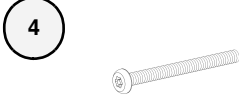
1 st. Tussenstap 60cm HPL	2 st. PE-Klem	4 st. Torx M10X30	6 st. Ring M10 (middel)
			
6 st. Lock Moer M10	2 st. Torx M10X50		
			

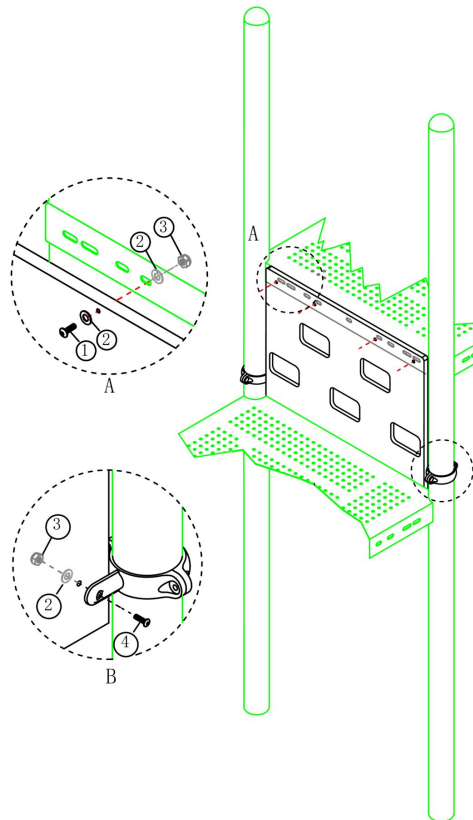

Bevestigings materiaal is per zakje verpakt en bovenstaande afbeelding zit in het zakje