

TnT speeltoestellen

Montagehandleiding

C-210



Toestel	C-210
Datum montagehandleiding	21-05-2026

Beste klant van TnT Speeltoestellen,

Wij danken u voor het aanschaffen en installeren van een speeltoestel van TnT Speeltoestellen. Wij waarderen het vertrouwen dat u in ons bedrijf heeft geplaatst en streven ernaar om uw vertrouwen meer dan waar te maken!

Dit is uw TnT speeltoestellen montagehandleiding.

Wij hebben deze handleiding specifiek voor het product ontworpen, waarop eveneens de toe te passen onderdelen zijn genoemd.

Ook vindt u het grondplan met de benodigde valruimte volgens norm NEN-EN1176-1 : 2017.

Bewaart u dit document bij uw logboek. Nogmaals willen wij u bedanken voor de aankoop van dit speeltoestel. Wij zien uit naar uw volgende speelproject.

Met vriendelijke groet, TnT Speeltoestellen

Inhoudsopgave

Aanzichten 3D	2
Onderdelenlijst	4
Veiligheidsruimtes	5
Zijaanzichten	6
Plattegrond palenplan	8
Paalmaten	9
Paaldata	10
Onderdeel handleidingen	11
Staander 320cm	12
Vloer vierkant (vloer_vierkant)	14
Ringladder kort (brug_klimrek_3_kort)	16
Metalen hekje (metalen_hekje)	26
Opgang doppen (opgang_doppen_120cm)	28
Half ronde opgang (klimrek_120cm_boog)	32
Opgang slang (b-klimmer_120cm)	36
Glijstang (glijstang_120cm)	40
Glijbaan kunststof recht (glijbaan_enkel_recht_120cm)	44

Aanzichten 3D



Aanzicht 1



Aanzicht 2

Aanzichten 3D







Aanzicht 3

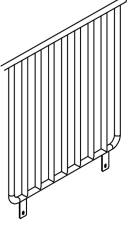
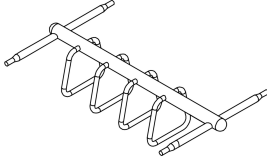
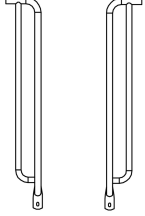
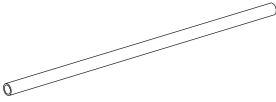
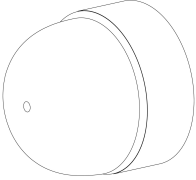
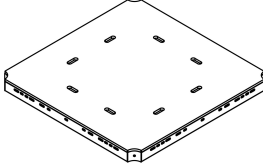
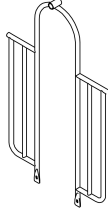

Aanzicht 4

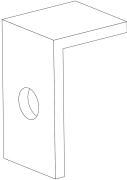
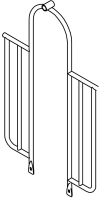
Onderdelenlijst

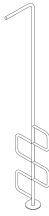
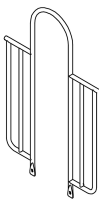
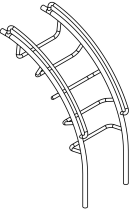
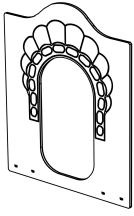
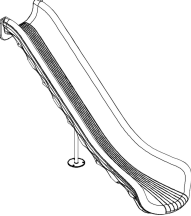
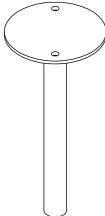
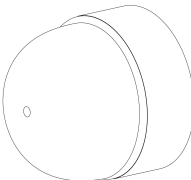
<p>8x Staander 320cm 320x11,5cm</p> 	<p>1x Balustrade metaal 105x101cm</p> 	<p>1x Ring ladder 116,5cm 116,5x101cm</p> 	<p>2x Handgrepen per 2 stuks 107x18cm</p> 
<p>2x Stang onder ladder Ø3,2x101cm</p> 	<p>16x Afdekdop M10 M10</p> 	<p>2x Vloer vierkant HPL 117x117x8,5cm</p> 	<p>1x Hekje tbv glijstang 152x101cm</p> 
<p>1x 120cm Glijstang 332x42</p> 	<p>2x Hoekje</p> 	<p>2x Hekje tbv: B, Pod en Curly Climber 152x101cm</p> 	<p>1x 120cm Pod climber 332x71cm</p> 
<p>1x 120cm B climber 332x44cm</p> 	<p>1x Hekje zonder bevestiging (boven) 152x101cm</p> 	<p>1x 120cm Arch climber 190x121x73cm</p> 	<p>1x Glijbaanpaneel HPL 120x98x2 cm</p> 
<p>1x 120cm glijbaan recht 250x80x57cm</p> 	<p>1x Glijbaanvoet voorkant 30x15cm</p> 	<p>2x Afdekdop M8 M8</p> 	

Zijaanzichten

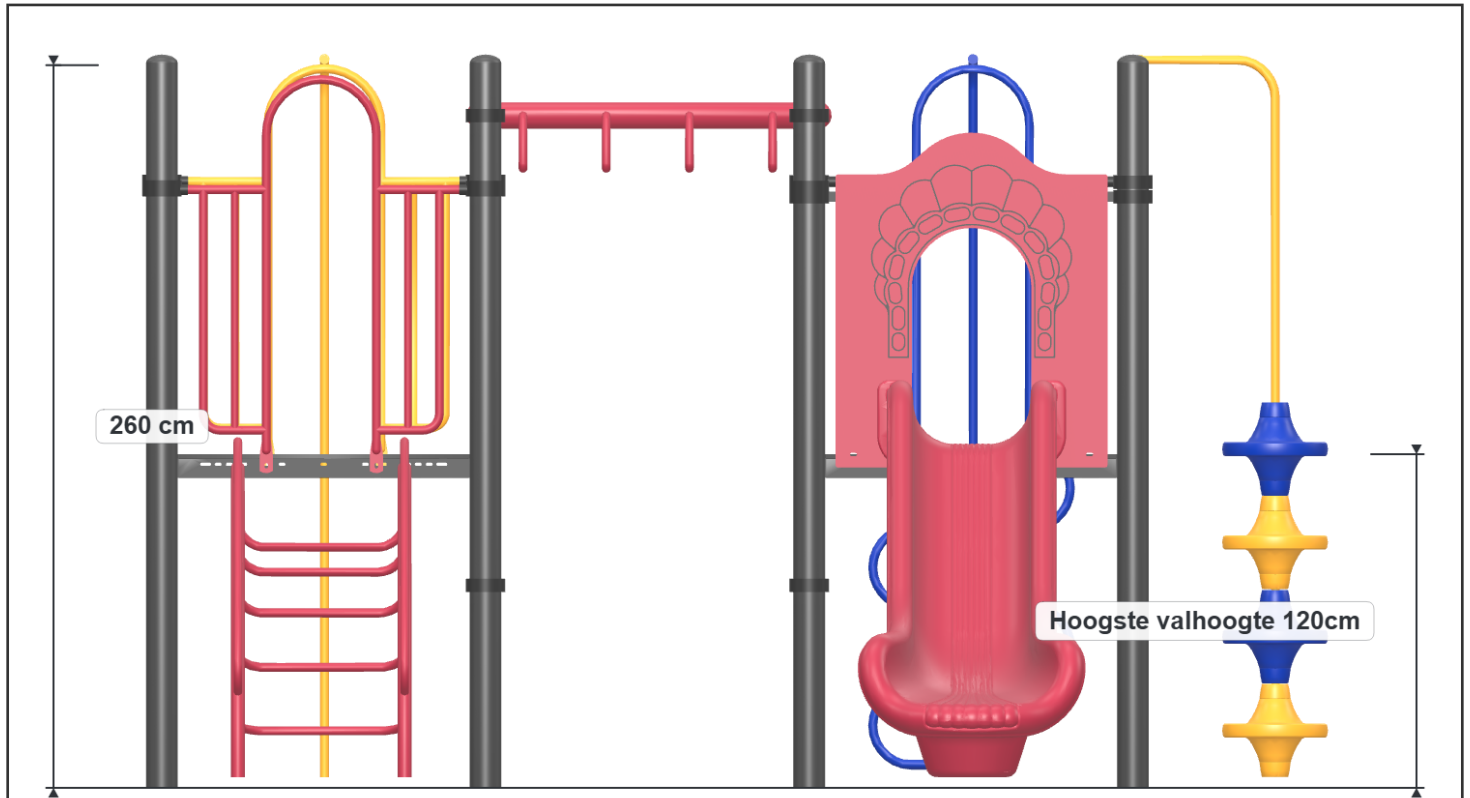

Aanzicht 1

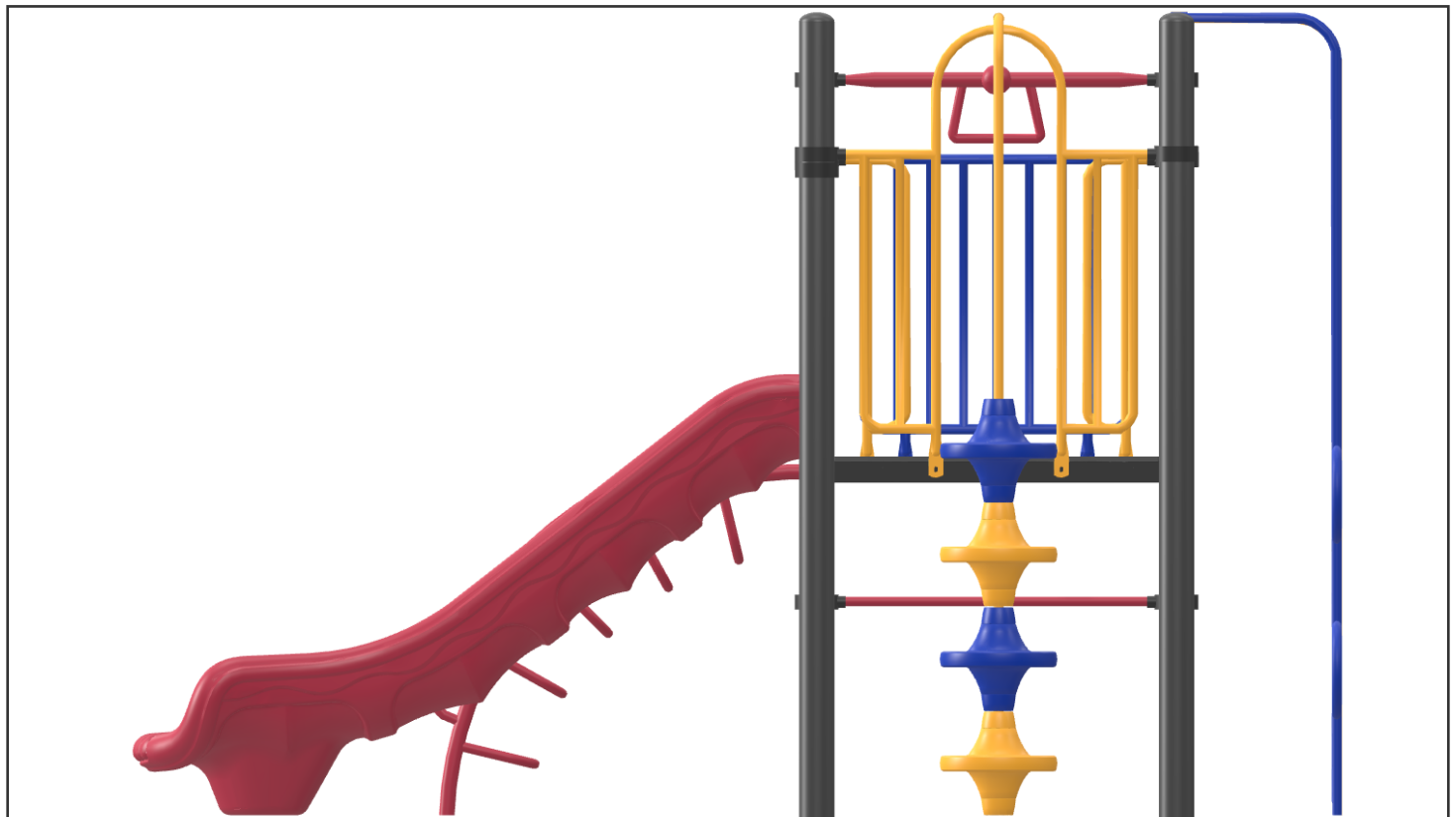

Aanzicht 2

Zijaanzichten

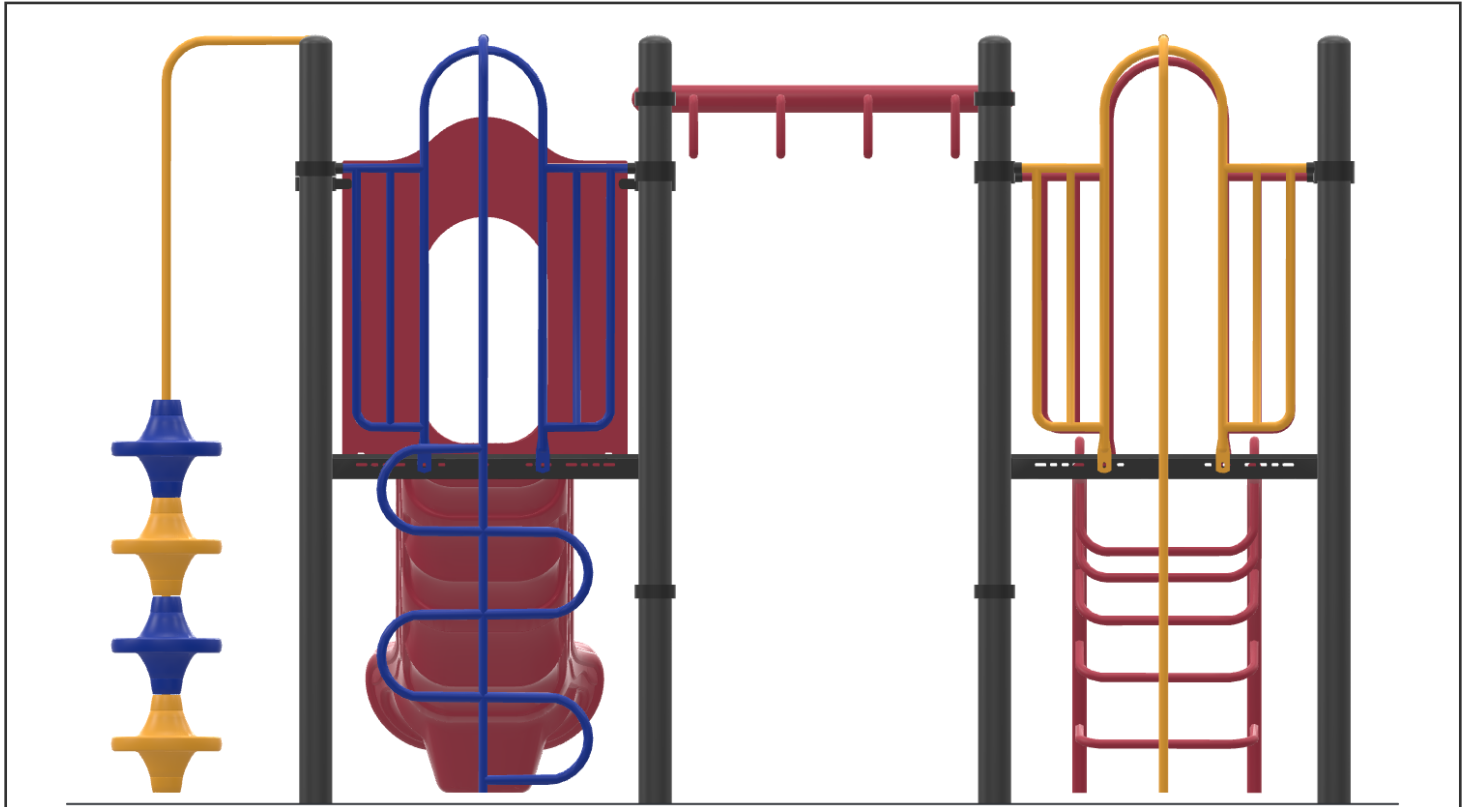

Aanzicht 3

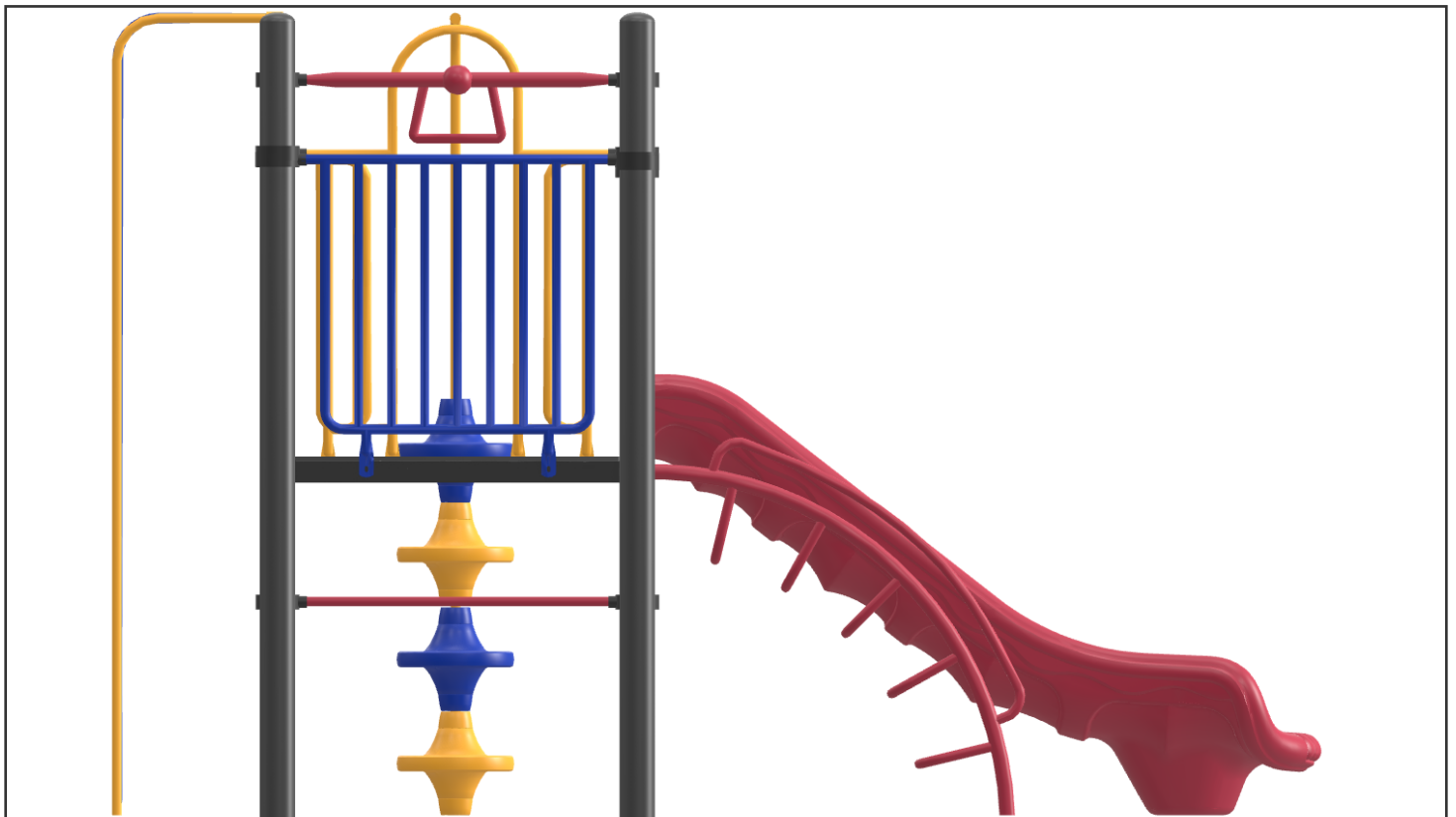

Aanzicht 4

Plattegrond palenplan

U kunt van deze tekening niet afmeten!

Voor de betonfundatie heeft u 37,5 kg snelbeton per staander nodig.

Voor de overige onderdelen (Glijstangen, Climbers, Glijbaan voeten) 25 kg snelbeton.

Houdt u er rekening mee dat de betonfundatie minimaal 400mm onder het maaiveld blijft, zoals op de tekening afgebeeld.

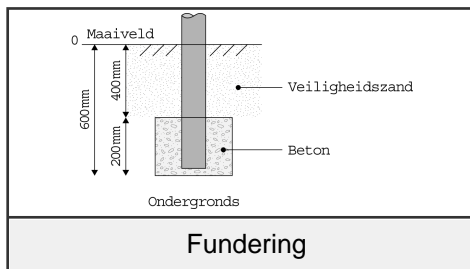
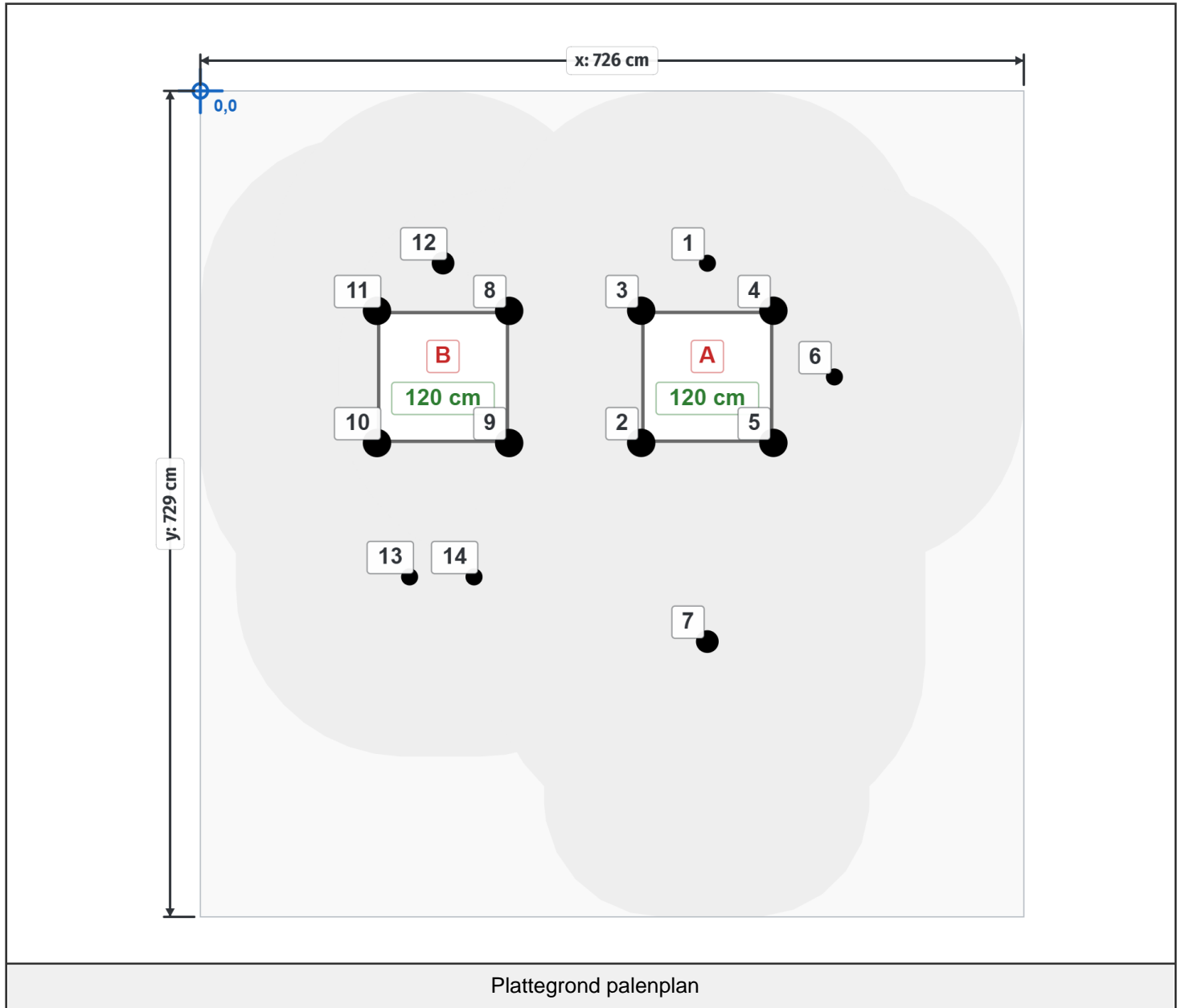

Paalmaten

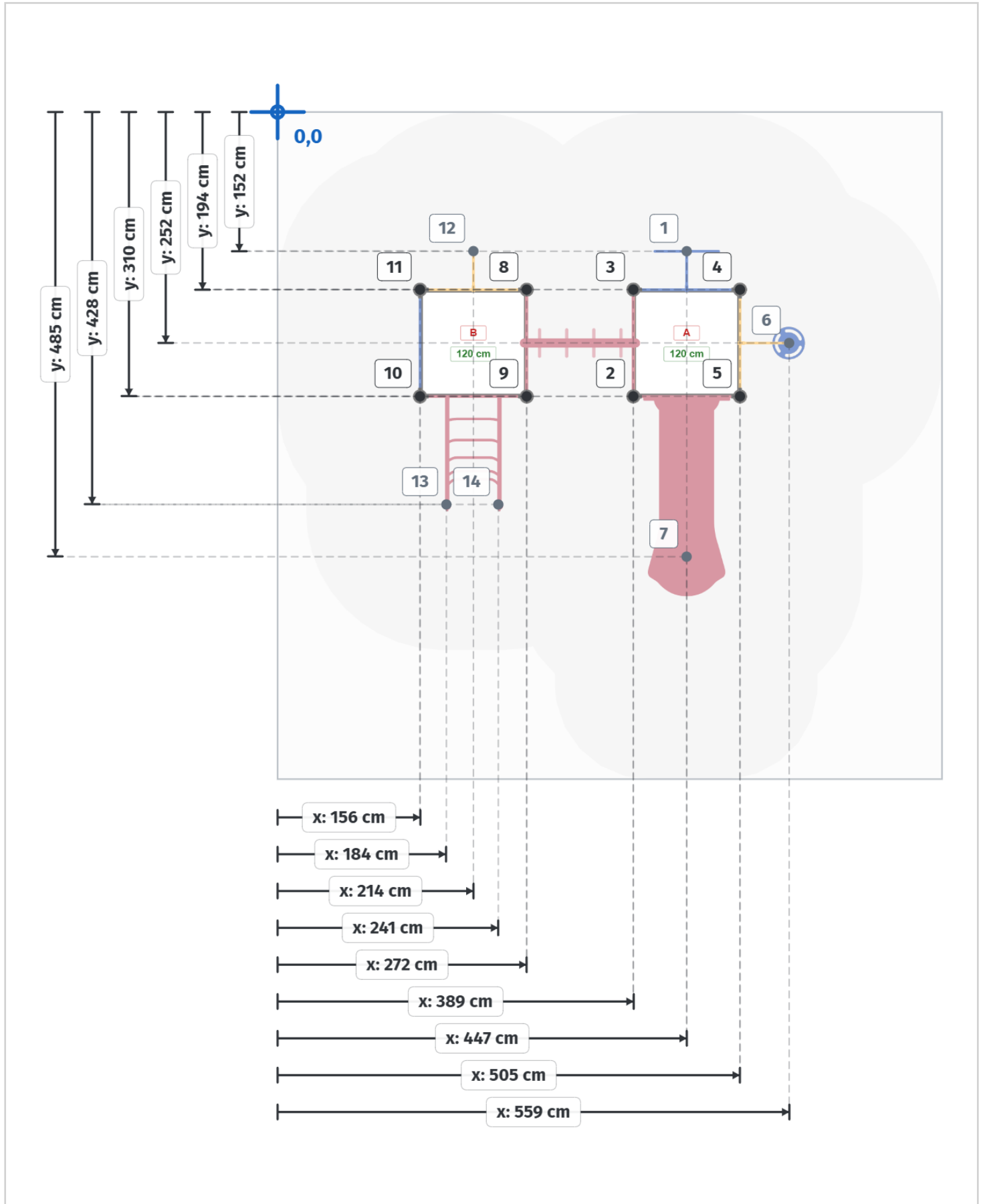

Paaldata

Staanders			
Label	X	Y	Hoogte
1	447 cm	152 cm	0 cm
2	389 cm	311 cm	320 cm
3	389 cm	194 cm	320 cm
4	506 cm	194 cm	320 cm
5	506 cm	311 cm	320 cm
6	559 cm	253 cm	0 cm
7	447 cm	486 cm	0 cm
8	273 cm	194 cm	320 cm
9	273 cm	311 cm	320 cm
10	156 cm	311 cm	320 cm
11	156 cm	194 cm	320 cm
12	214 cm	152 cm	0 cm
13	185 cm	429 cm	0 cm
14	242 cm	429 cm	0 cm

Vloeren	
Label	Hoogte
A	120 cm
B	120 cm

Onderdeel handleidingen

Op de volgende pagina's van dit document vindt u alle individuele onderdelen met bijbehorende technische tekeningen en eventuele montage instructies.

Staander 320cm

Hoofdafmetingen: 320x11,5cm

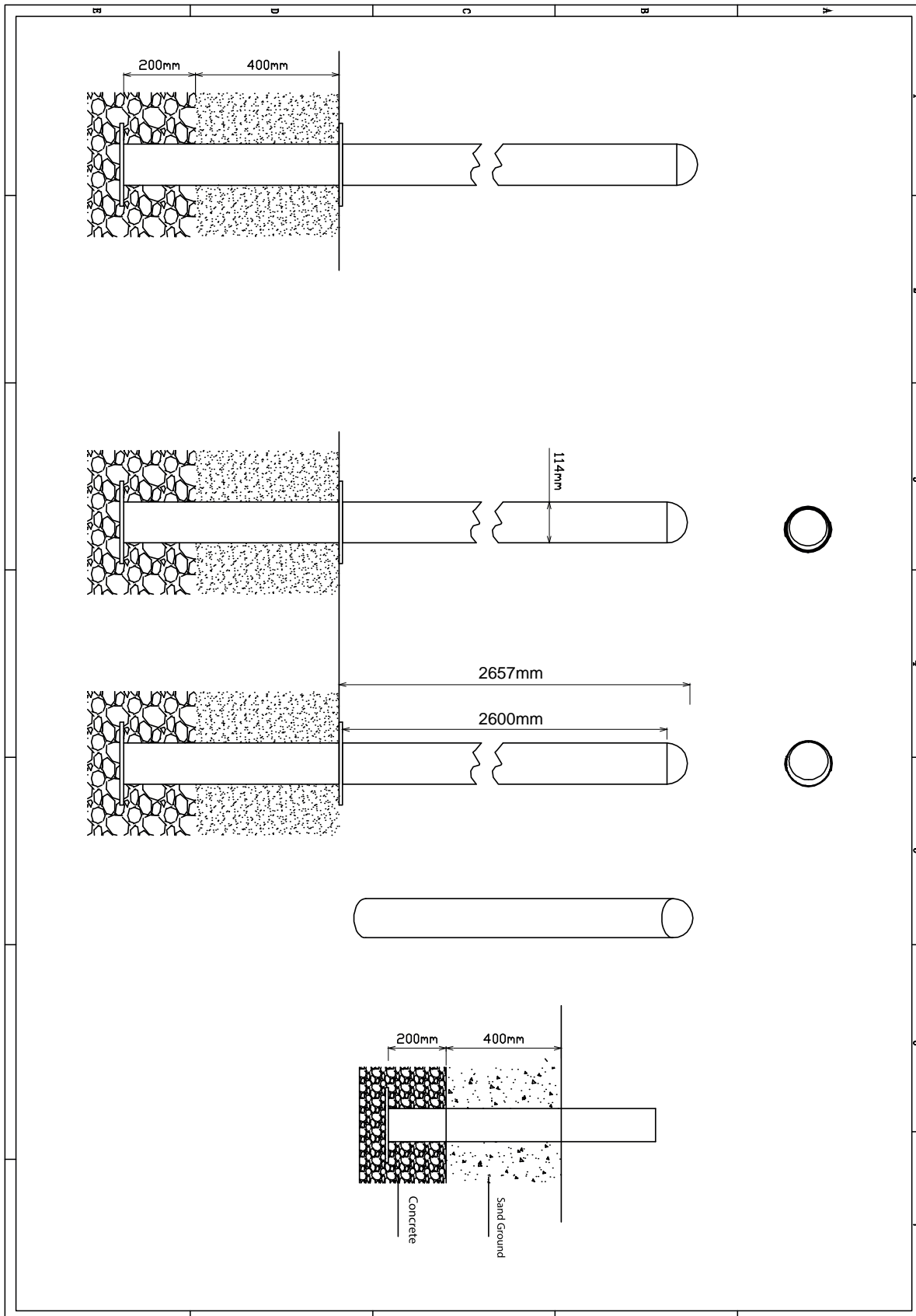

Staander

STAP 1 van 1

Omschrijving: Paalkap losdraaien en opnieuw bevestigen met loctite op het draadeind

1 st. Loctite

1

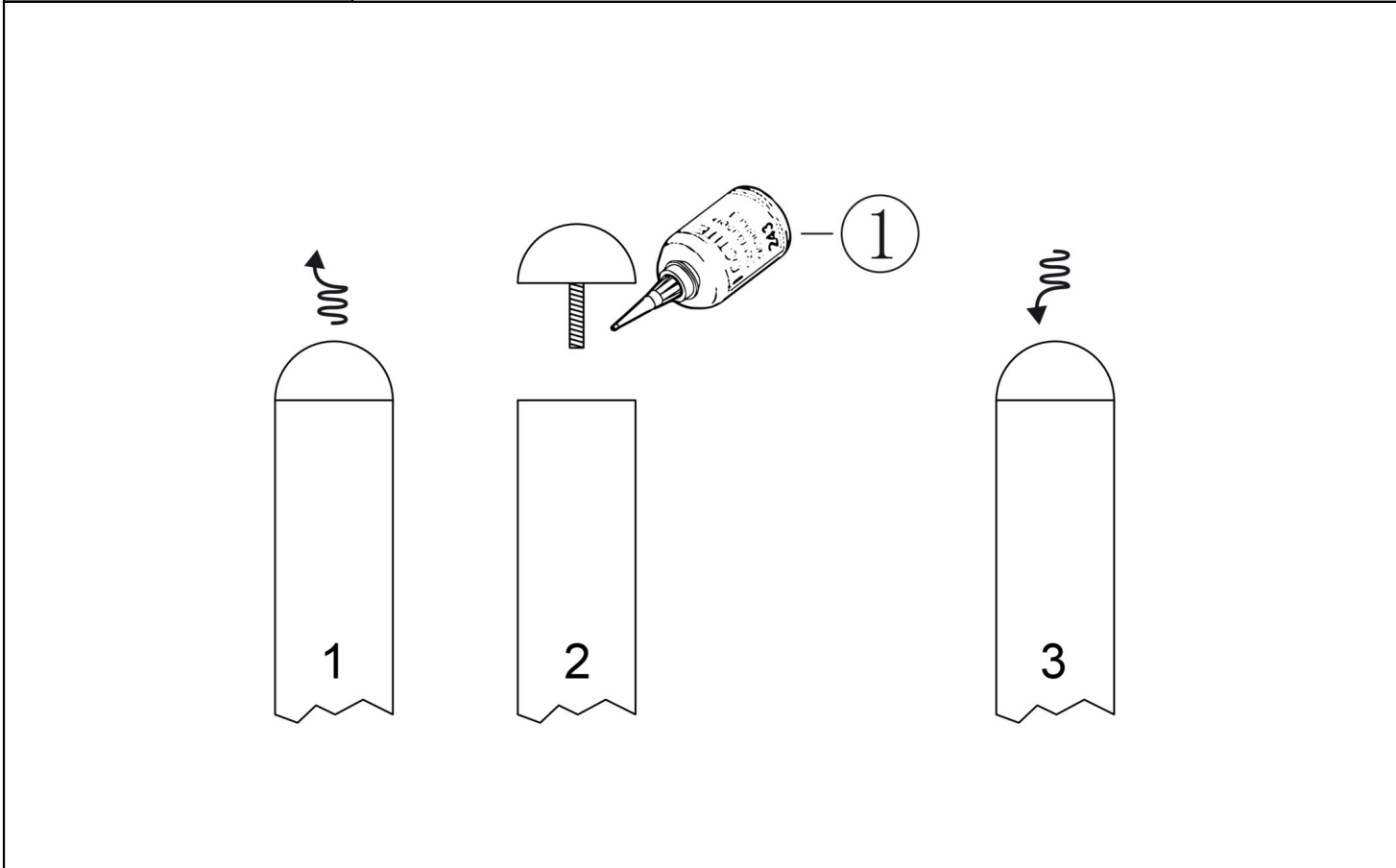

Bevestigings materiaal is per zakje verpakt en bovenstaande afbeelding zit in het zakje

Vloer vierkant HPL

Hoofdafmetingen: 117x117x8,5cm

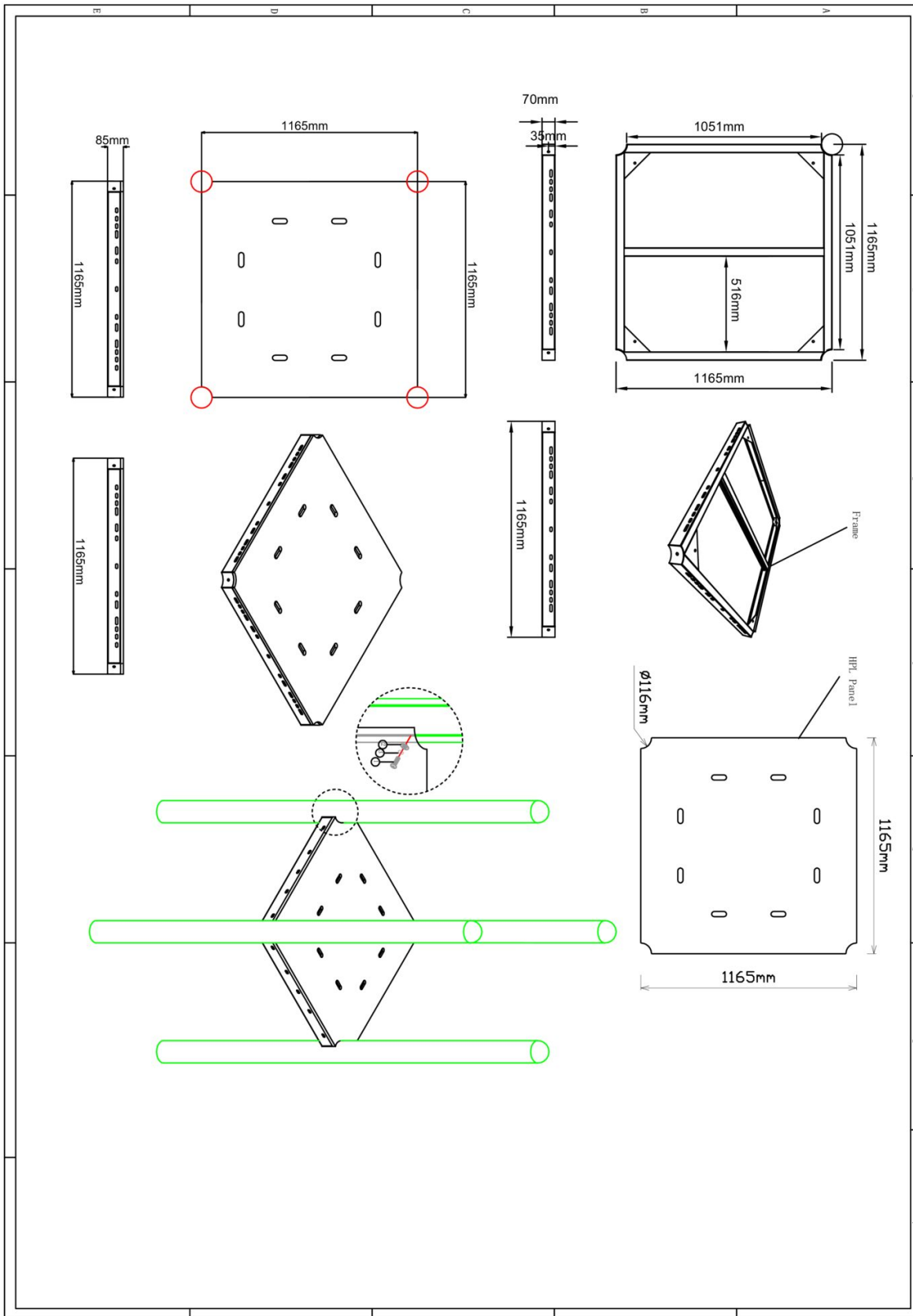

Vloer vierkant HPL

STAP 1 van 1

Omschrijving: Bevestiging van de vloer aan de staander. In de staander zitten al voor gemonteerde M10 bussen op de juiste hoogte waar de bout ingedraaid dienen te worden.

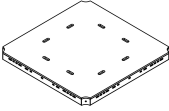
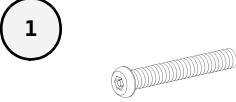
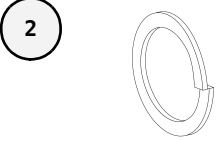
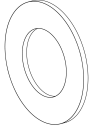
1 st. Vloer vierkant HPL	4 st. Torx M10X30	4 st. Veerring M10	4 st. Ring M10 (middel)
	<p>1</p> 	<p>2</p> 	<p>3</p> 

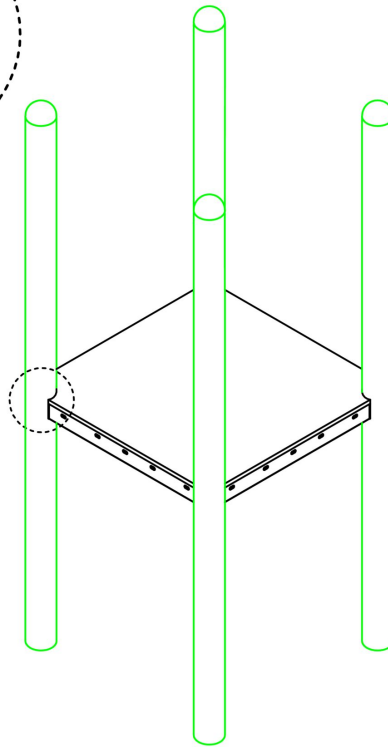
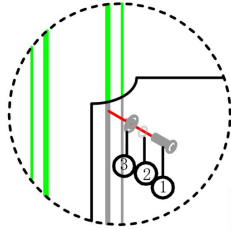

Bevestigings materiaal is per zakje verpakt en bovenstaande afbeelding zit in het zakje

Ring ladder 116,5cm

Hoofdafmetingen: 116,5x101cm

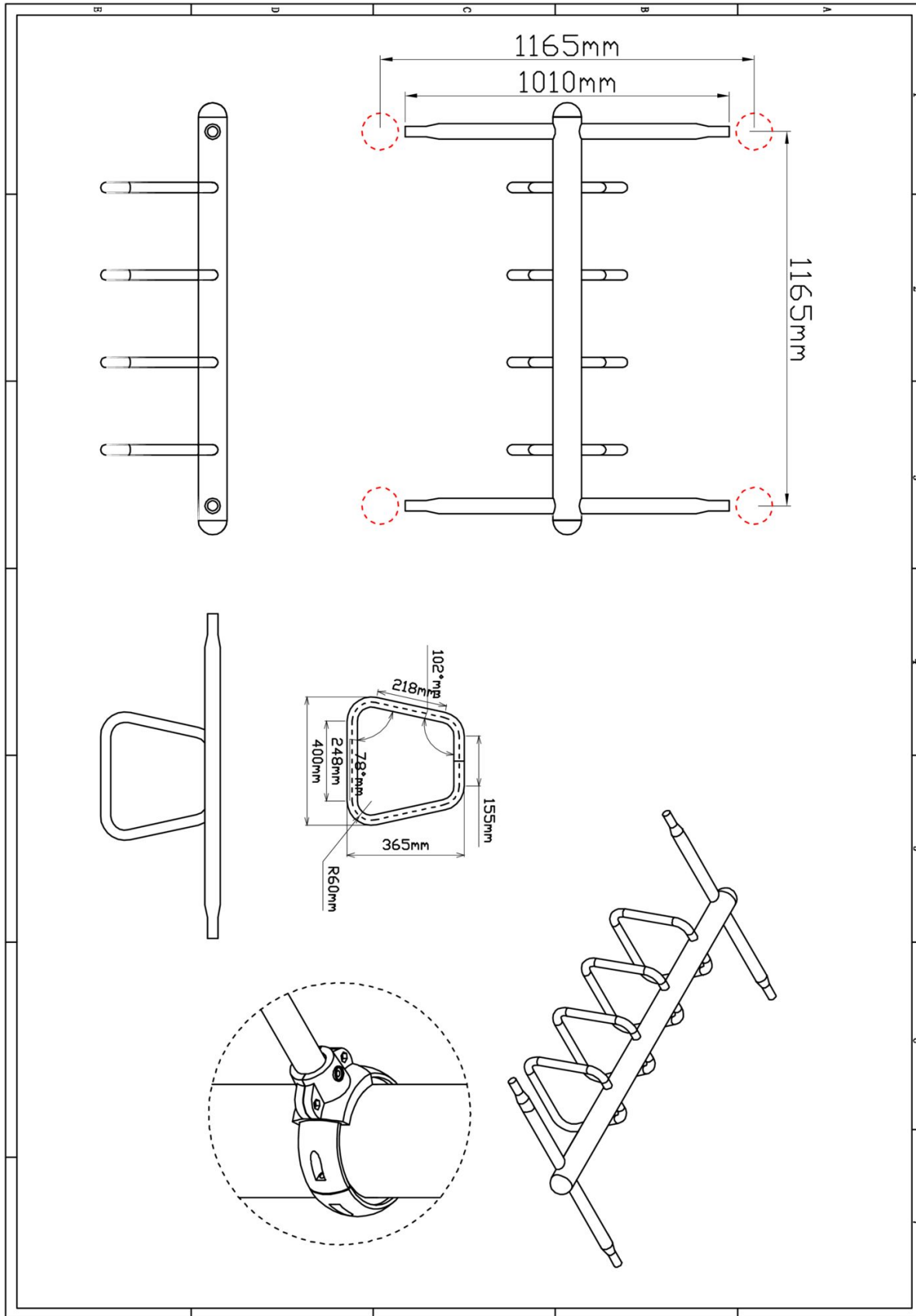

Ring ladder 116,5cm

STAP 1 van 3

Omschrijving: Zelftap bouten aanbrengen aan de binnenkant van de palen

4 st. Zeskant M3X16 Zelftap	
1	

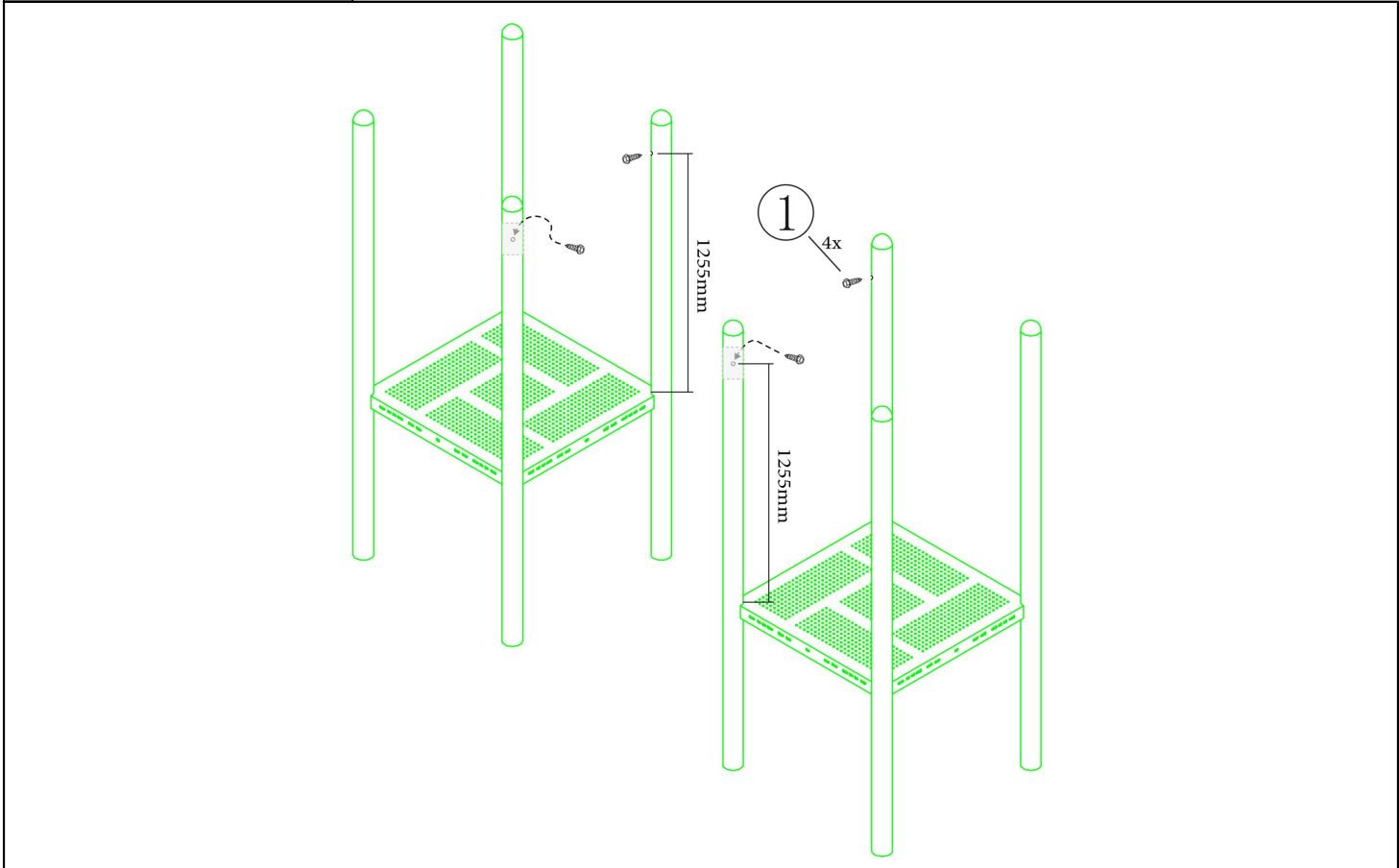

Bevestigings materiaal is per zakje verpakt en bovenstaande afbeelding zit in het zakje

Ring ladder 116,5cm

STAP 2 van 3

Omschrijving: Koppelingsring over de schroef schuiven en vastzetten zodat de schroef niet meer zichtbaar is en de ring door de schroef niet kan zakken op de paal

4 st. Small clamp + ring

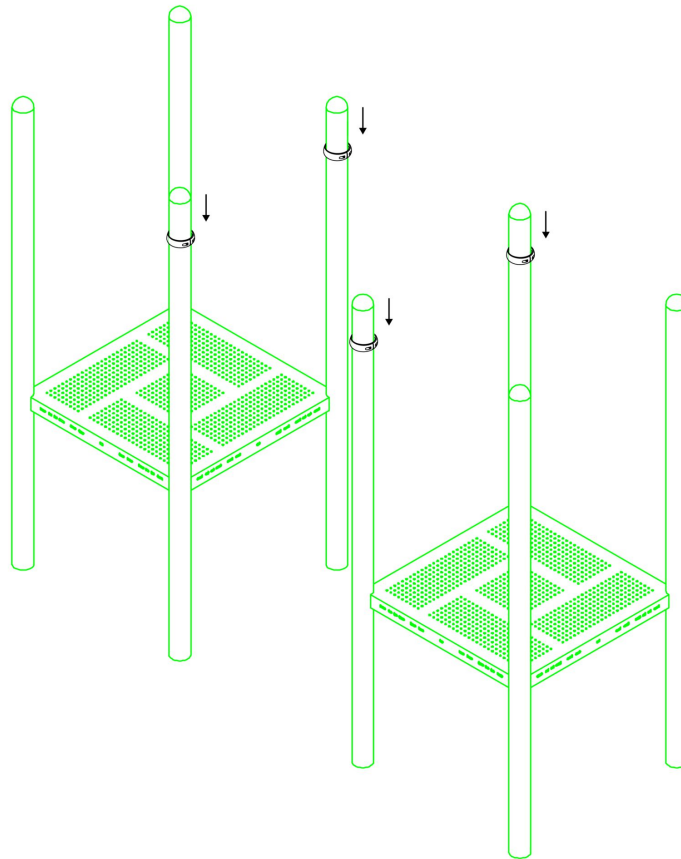



Bevestigings materiaal is per zakje verpakt en bovenstaande afbeelding zit in het zakje

Ring ladder 116,5cm

STAP 3 van 3

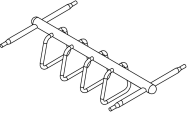
Omschrijving: Bevestiging tussen de ring ladder en de staander. De bevestigingsring van de ring ladder moet vanaf de vloer gemeten op 125cm hoogte hangen

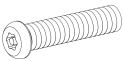
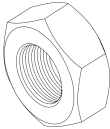
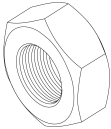
<p>1 st. Ring ladder 116,5cm</p> 	<p>4 st. Kruiskop M6X65</p> <p>1</p> 	
<p>8 st. Torx M8X20</p> <p>2</p> 	<p>8 st. Lock Moer M8</p> <p>3</p> 	<p>4 st. Lock Moer M6</p> <p>4</p> 

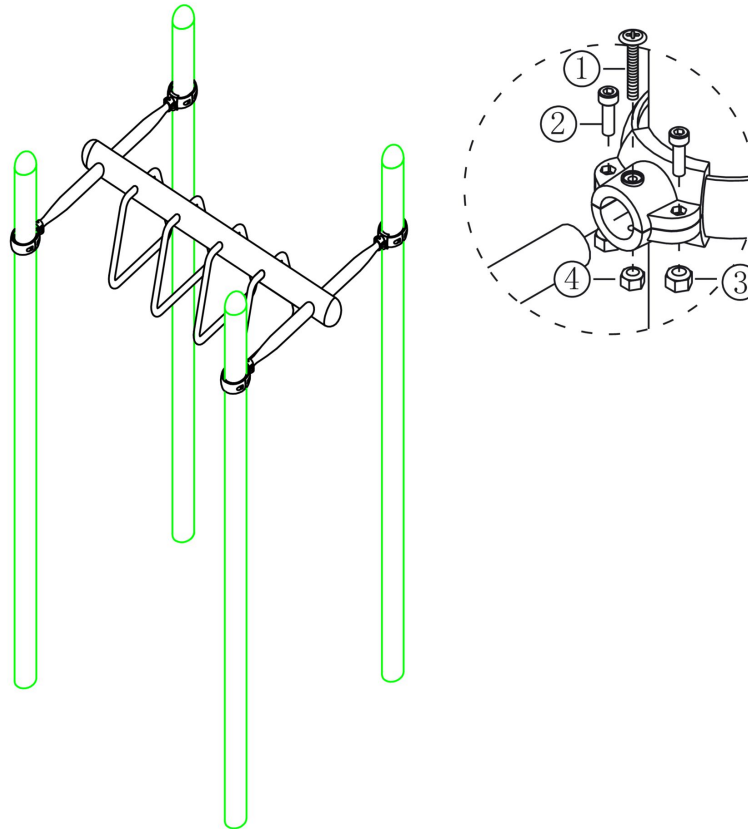

Bevestigings materiaal is per zakje verpakt en bovenstaande afbeelding zit in het zakje

Handgrepen per 2 stuks



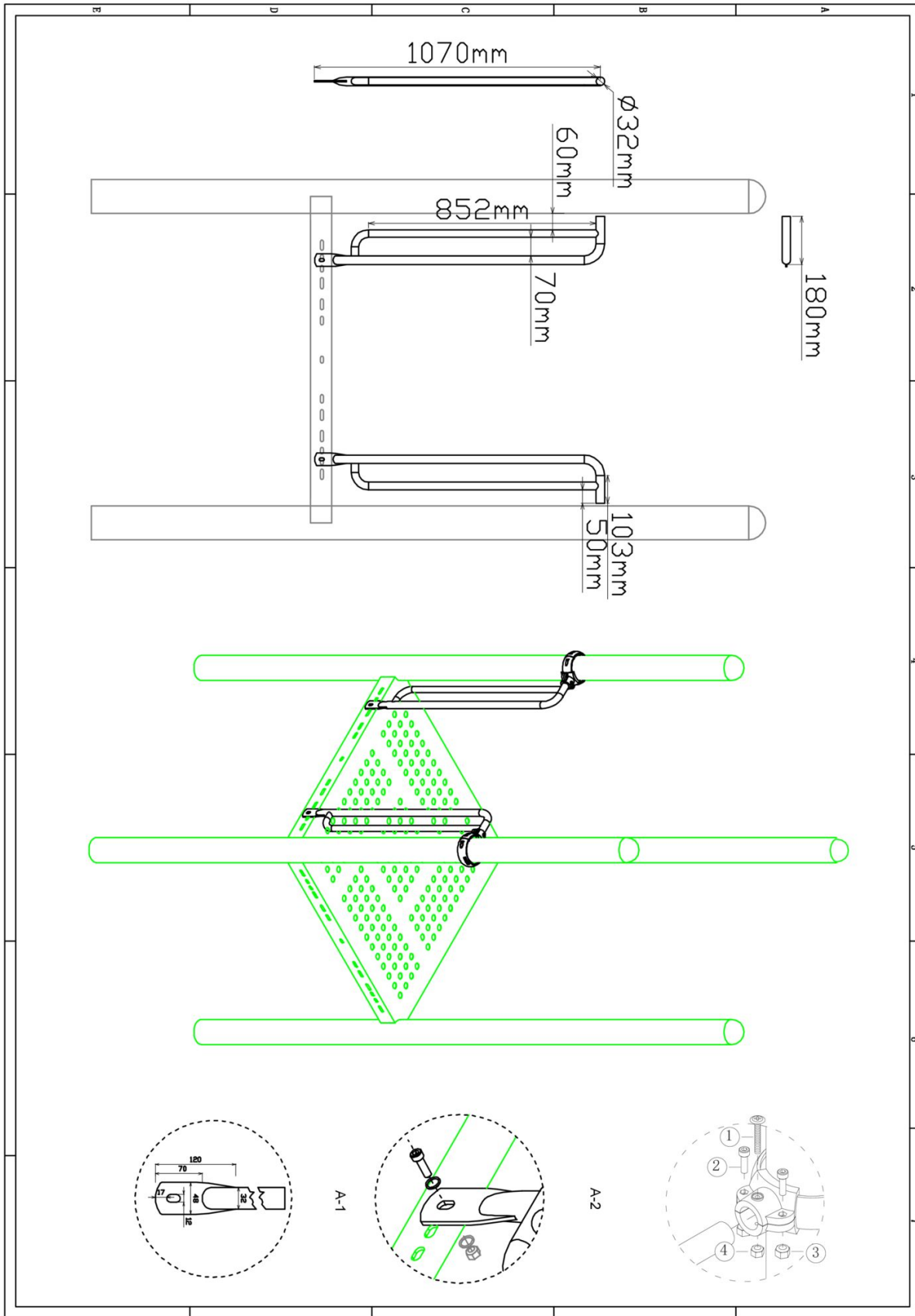

Hoofdafmetingen: 107x18cm

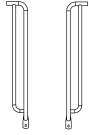

Handgrepen per 2 stuks

STAP 1 van 1

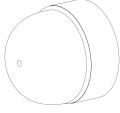
Omschrijving: Bevestiging tussen de vloer/staander en de handgrepen

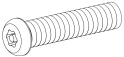
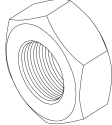
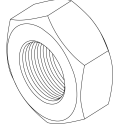
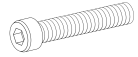
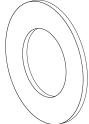
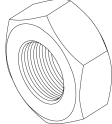
1 st. Handgrepen per 2 stuks	2 st. Small clamp + ring	2 st. Afdekdop M10	2 st. Kruiskop M6X65
			
4 st. Torx M8X20	4 st. Lock Moer M8	4 st. Lock Moer M6	2 st. Bout M10X25
			
4 st. Ring M10 (middel)	2 st. Lock Moer M10		
			

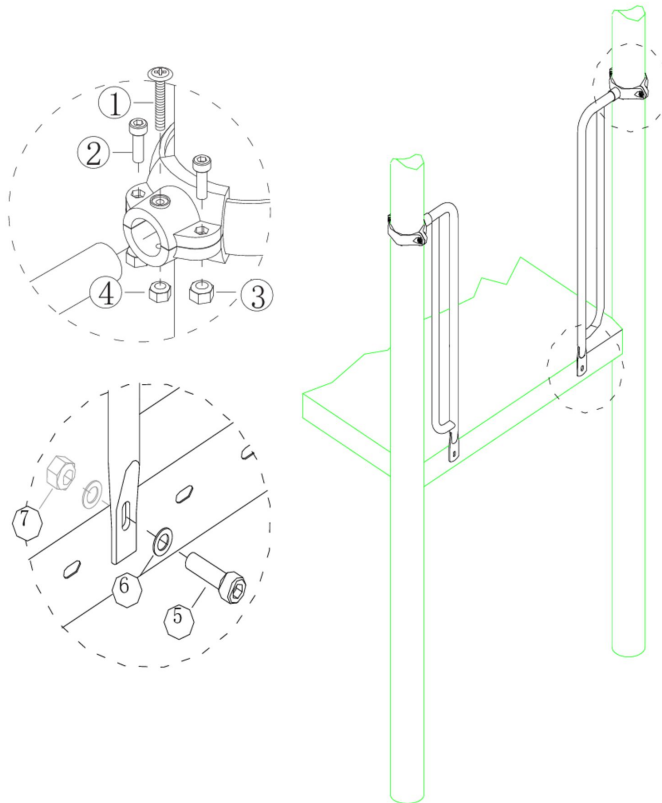

Bevestigings materiaal is per zakje verpakt en bovenstaande afbeelding zit in het zakje

Stang onder ladder

Hoofdafmetingen: $\emptyset 3,2 \times 101 \text{cm}$

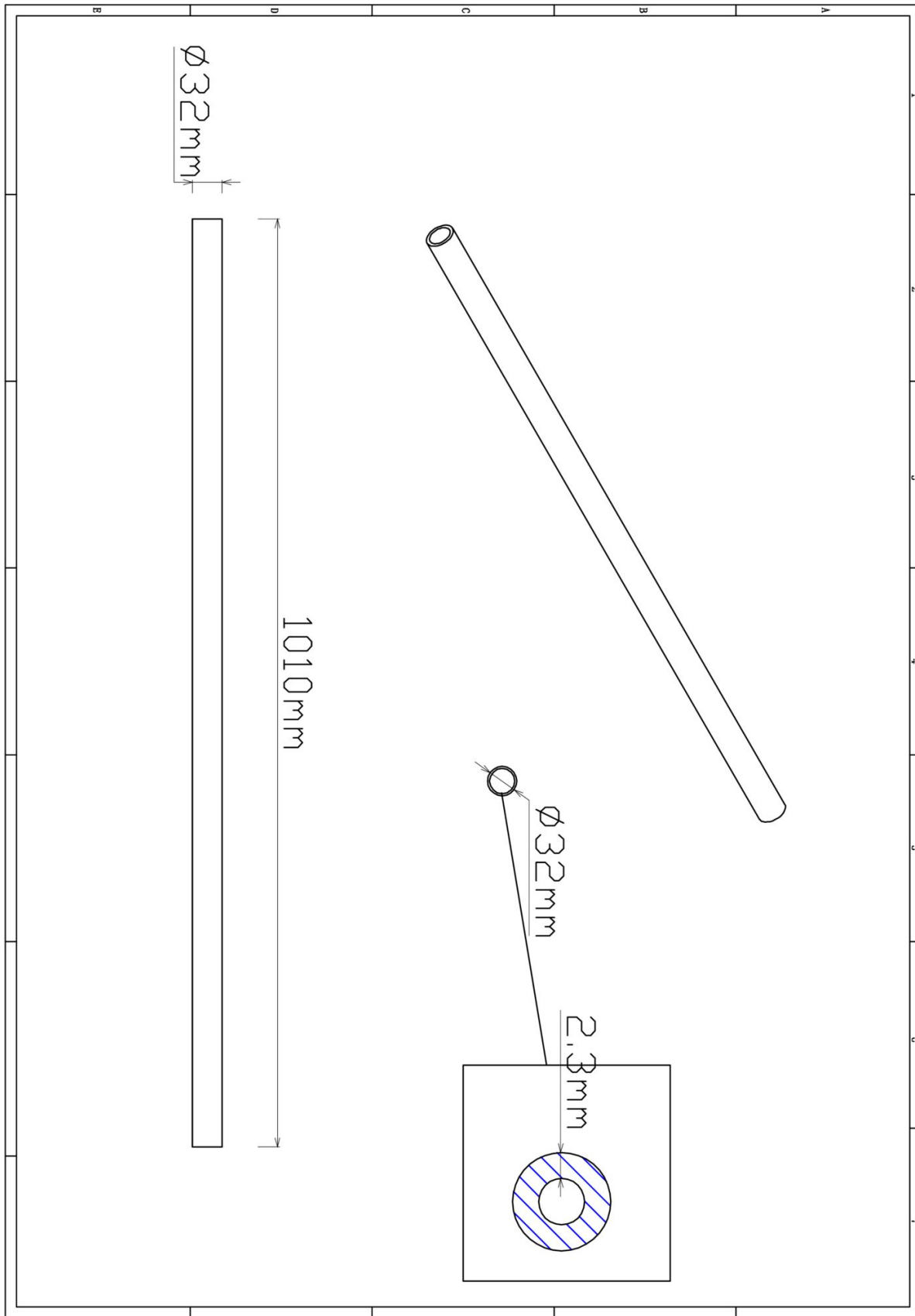

Stang onder ladder

STAP 1 van 3

Omschrijving: Zelftap bouten aanbrengen aan de binnenkant van de palen

2 st. Zeskant M3X16 Zelftap	
1	

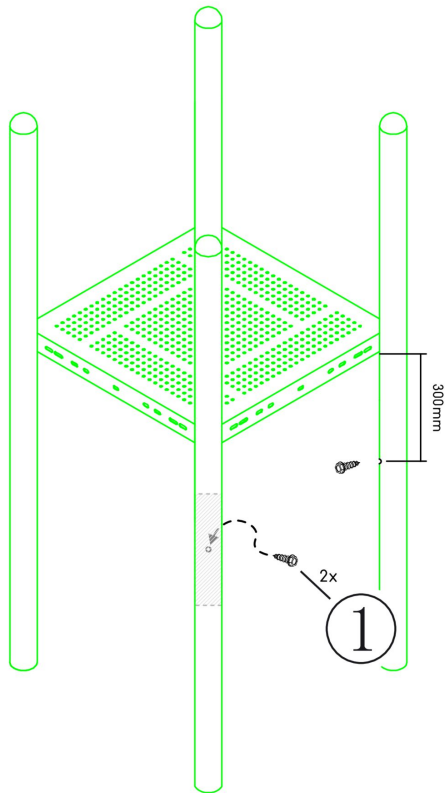

Bevestigings materiaal is per zakje verpakt en bovenstaande afbeelding zit in het zakje

Stang onder ladder

STAP 2 van 3

Omschrijving: Koppelingsring over de schroef schuiven en vastzetten zodat de schroef niet meer zichtbaar is en de ring door de schroef niet kan zakken op de paal

2 st. Small clamp + ring

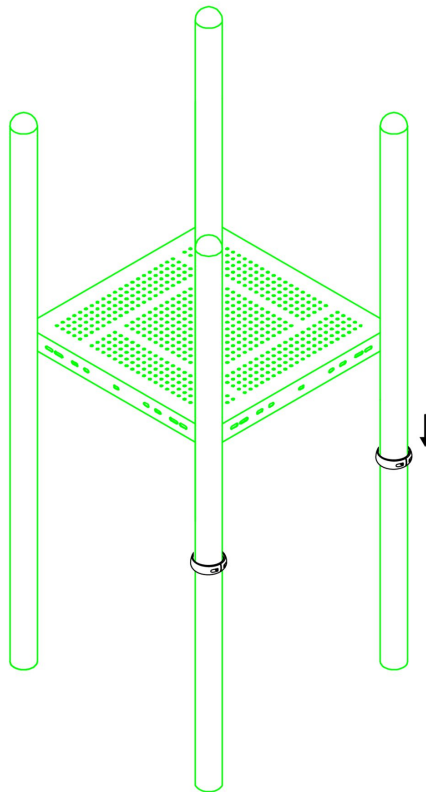

Bevestigings materiaal is per zakje verpakt en bovenstaande afbeelding zit in het zakje

Stang onder ladder

STAP 3 van 3

Omschrijving: Stang vastzetten met behulp van de klemmen

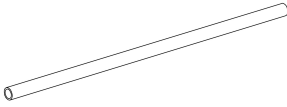
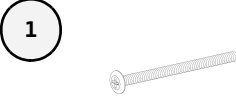
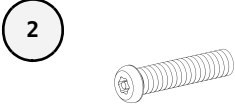
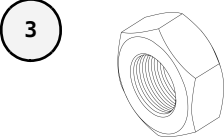
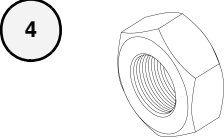
1 st. Stang onder ladder	2 st. Kruiskop M6X65	
		
4 st. Torx M8X20	4 st. Lock Moer M8	2 st. Lock Moer M6
		

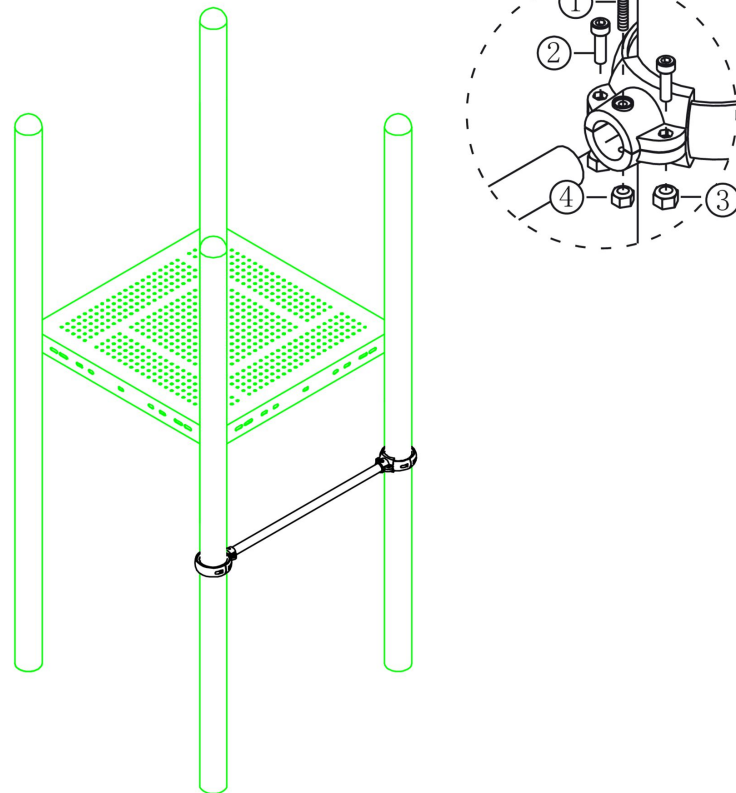

Bevestigings materiaal is per zakje verpakt en bovenstaande afbeelding zit in het zakje

Balustrade metaal



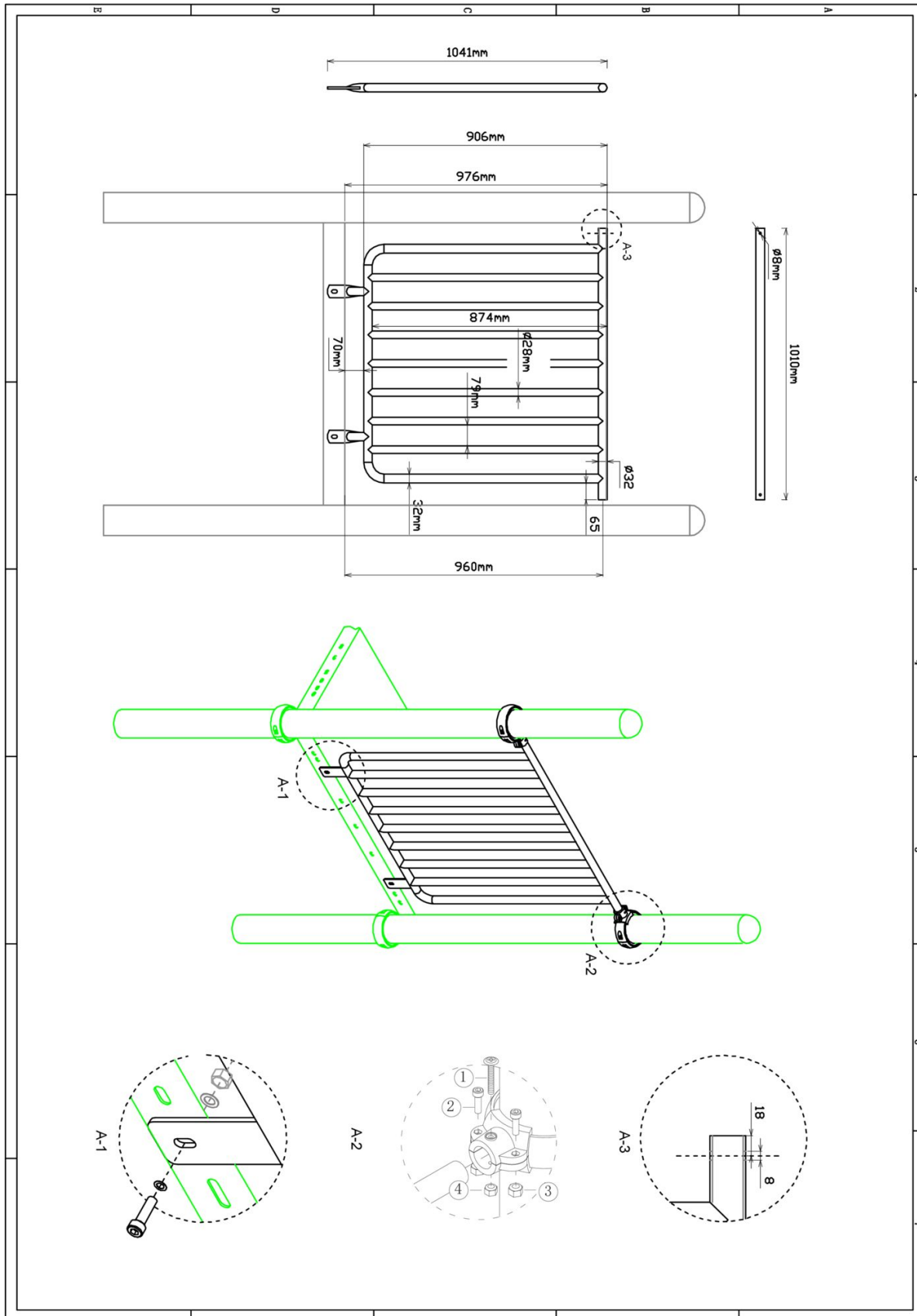



Hoofdafmetingen: 105x101cm

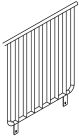

Balustrade metaal

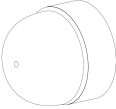
STAP 1 van 1

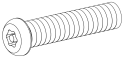
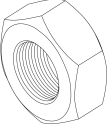
Omschrijving: Bevestiging tussen de vloer/staander

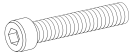
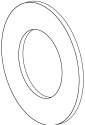
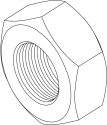
1 st. Balustrade metaal	2 st. Small clamp + ring	2 st. Afdekdop M10	2 st. Kruiskop M6X65
			① 
4 st. Torx M8X20	4 st. Lock Moer M8	2 st. Lock Moer M6	2 st. Bout M10X25
② 	③ 	④ 	⑤ 
4 st. Ring M10 (middel)	2 st. Lock Moer M10		
⑥ 	⑦ 		

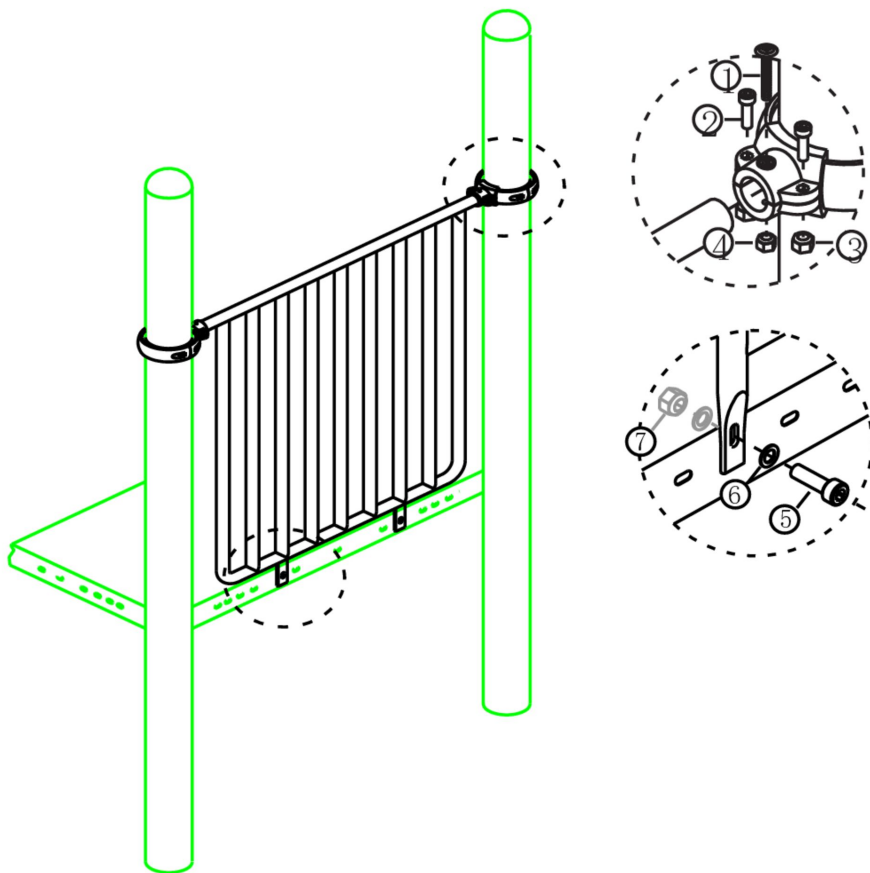

Bevestigings materiaal is per zakje verpakt en bovenstaande afbeelding zit in het zakje

Hekje tbv: B, Pod en Curly Climber



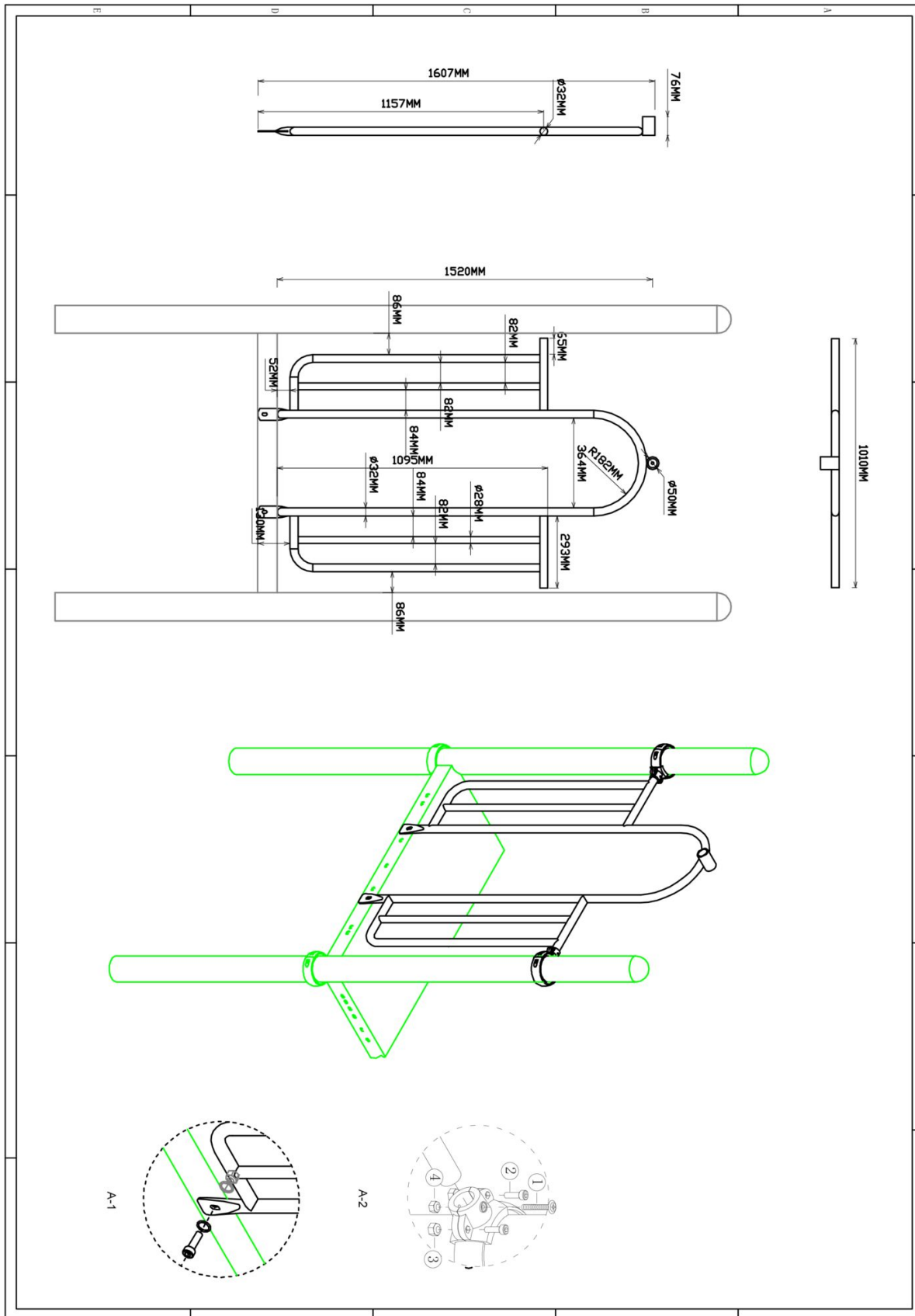

Hoofdafmetingen: 152x101cm

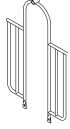

Hekje tbv: B, Pod en Curly Climber

STAP 1 van 1

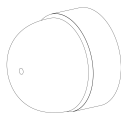
Omschrijving: Bevestiging van het hek tussen de vloer/staander

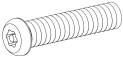
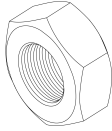
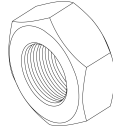
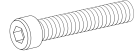
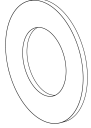
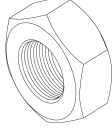
1 st. Hekje tbv: B, Pod en Curly Climber	2 st. Small clamp + ring	2 st. Afdekdop M10	2 st. Kruiskop M6X65
			① 
4 st. Torx M8X20	4 st. Lock Moer M8	2 st. Lock Moer M6	2 st. Bout M10X25
② 	③ 	④ 	⑤ 
4 st. Ring M10 (middel)	2 st. Lock Moer M10		
⑥ 	⑦ 		

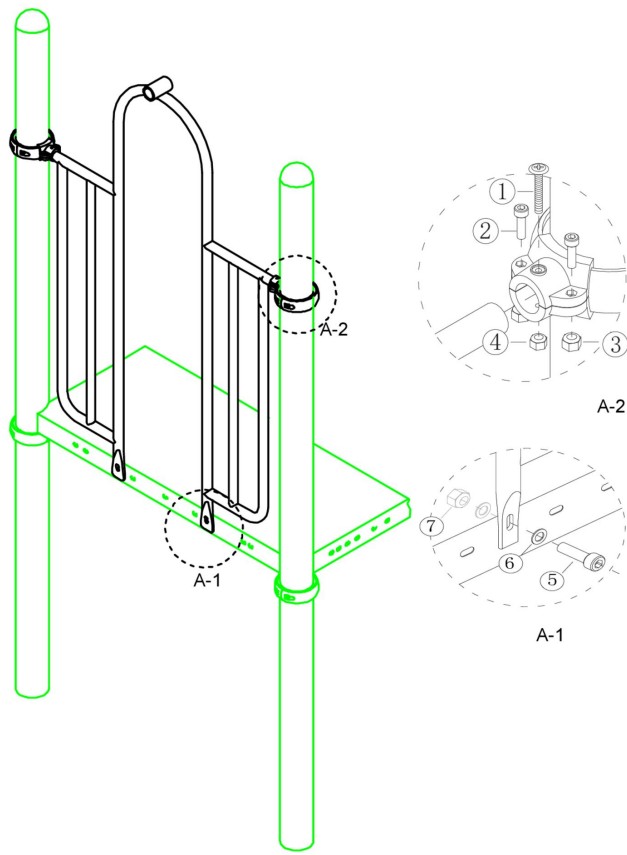

Bevestigings materiaal is per zakje verpakt en bovenstaande afbeelding zit in het zakje

120cm Pod climber

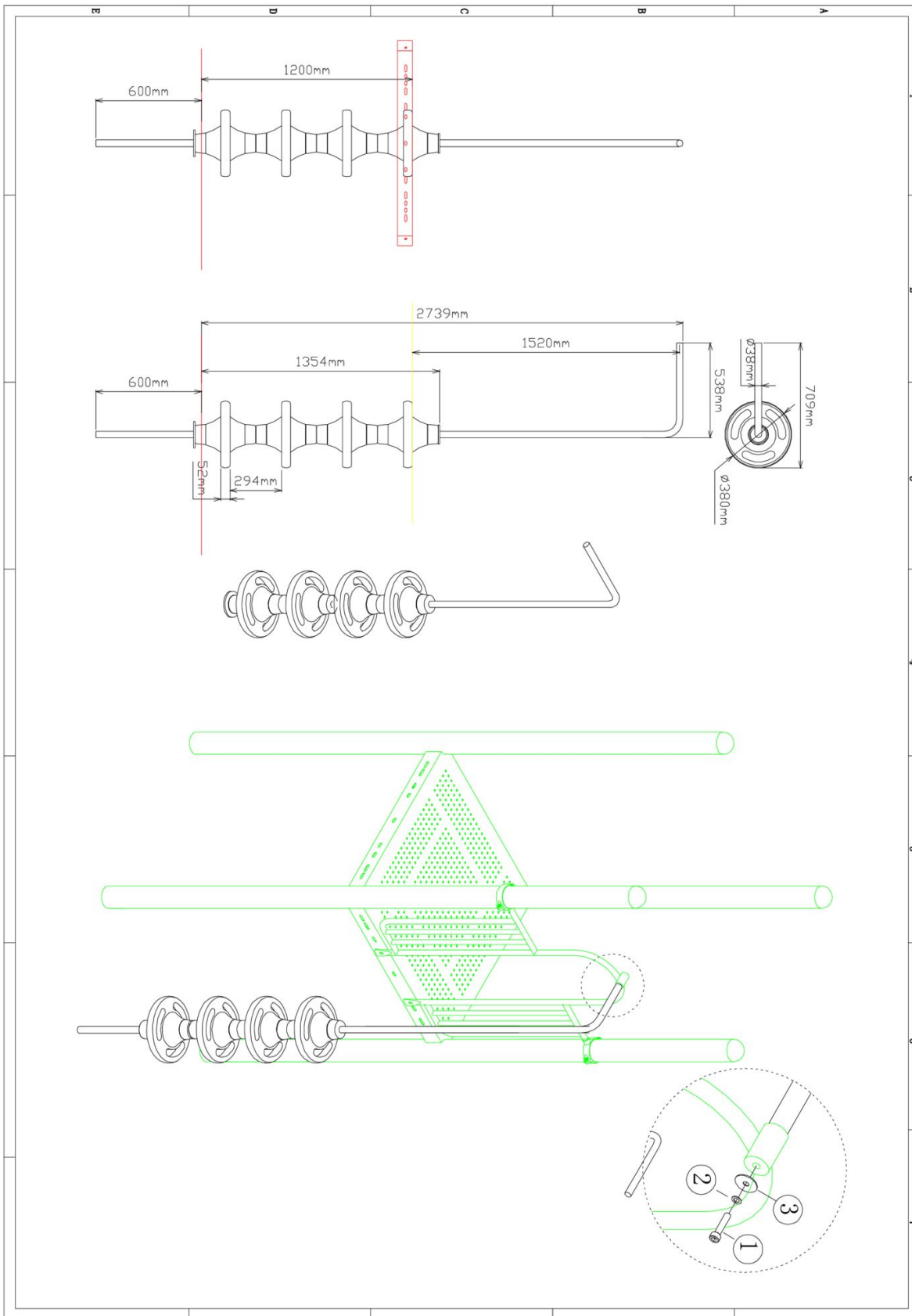

Hoofdafmetingen: 332x71cm



120cm Pod climber

STAP 1 van 1

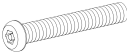
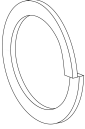
Omschrijving: Bevestiging tussen hek en pod climber

1 st. 120cm Pod climber	1 st. Torx M10X30	1 st. Veerring M10	1 st. Ring M10 (middel)
			

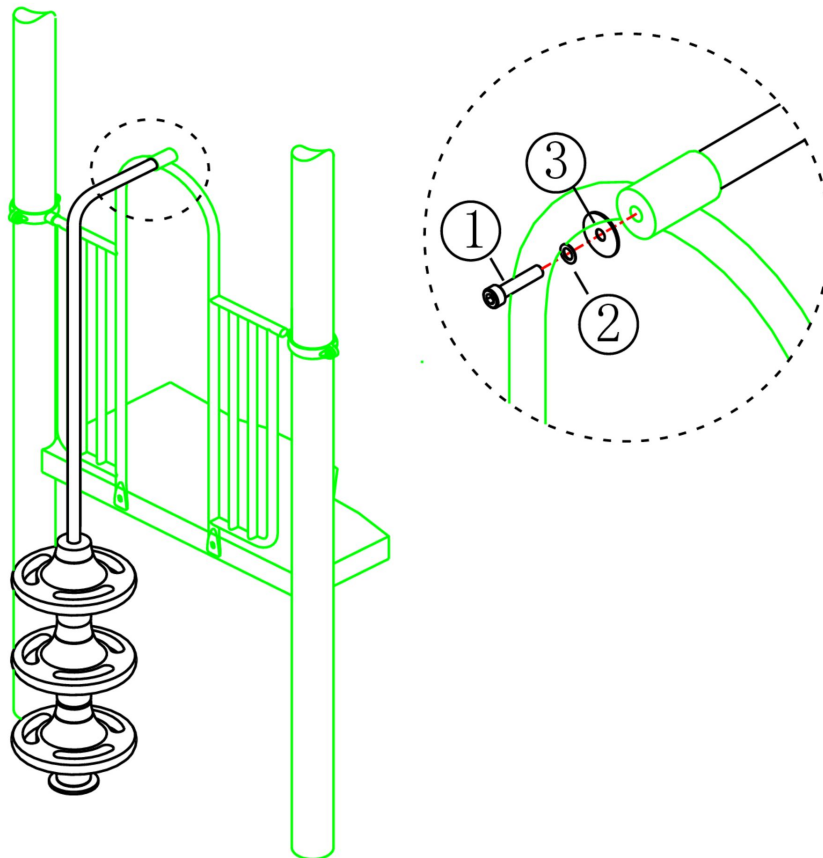

Bevestigings materiaal is per zakje verpakt en bovenstaande afbeelding zit in het zakje

Hekje zonder bevestiging (boven)



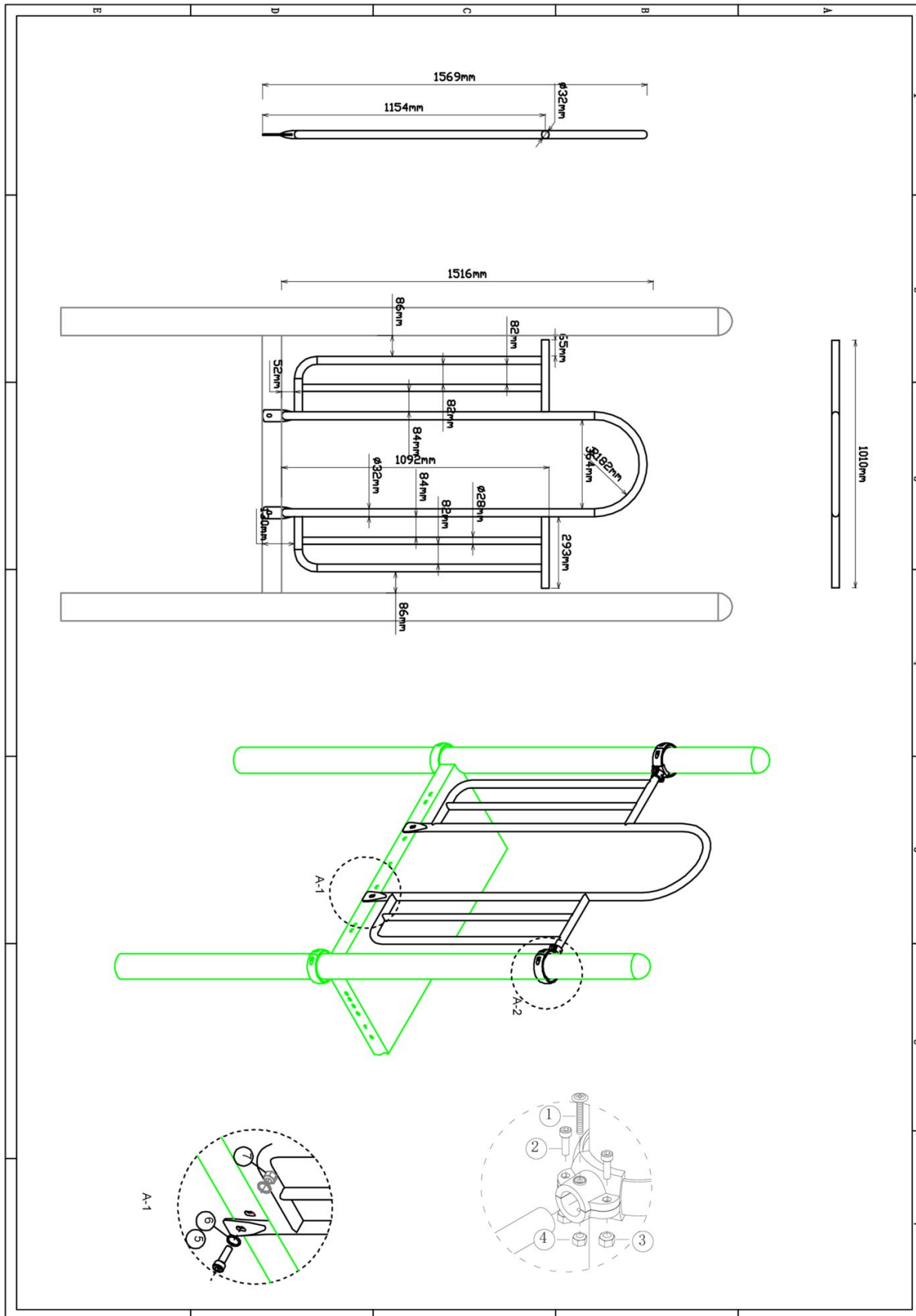

Hoofdafmetingen: 152x101cm

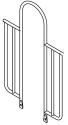

Hekje zonder bevestiging (boven)

STAP 1 van 1

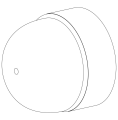
Omschrijving: Bevestiging van het hek tussen de vloer/staander

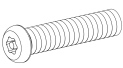
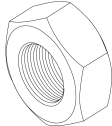
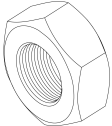
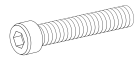
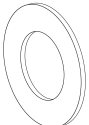
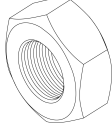
1 st. Hekje zonder bevestiging (boven)	2 st. Small clamp + ring	2 st. Afdekdop M10	2 st. Kruiskop M6X65
			
4 st. Torx M8X20	4 st. Lock Moer M8	2 st. Lock Moer M6	2 st. Bout M10X25
			
4 st. Ring M10 (middel)	2 st. Lock Moer M10		
			

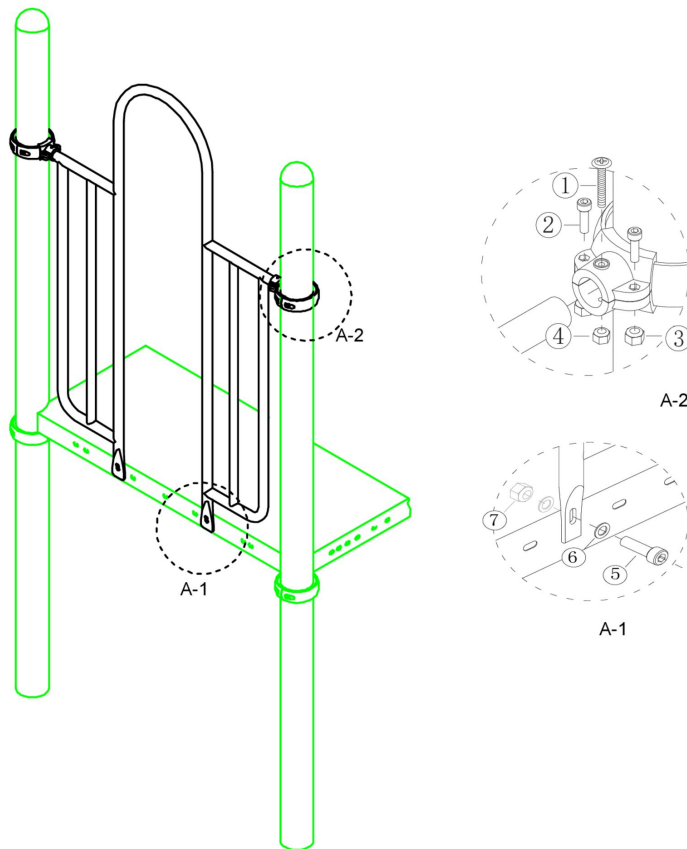

Bevestigings materiaal is per zakje verpakt en bovenstaande afbeelding zit in het zakje

120cm Arch climber

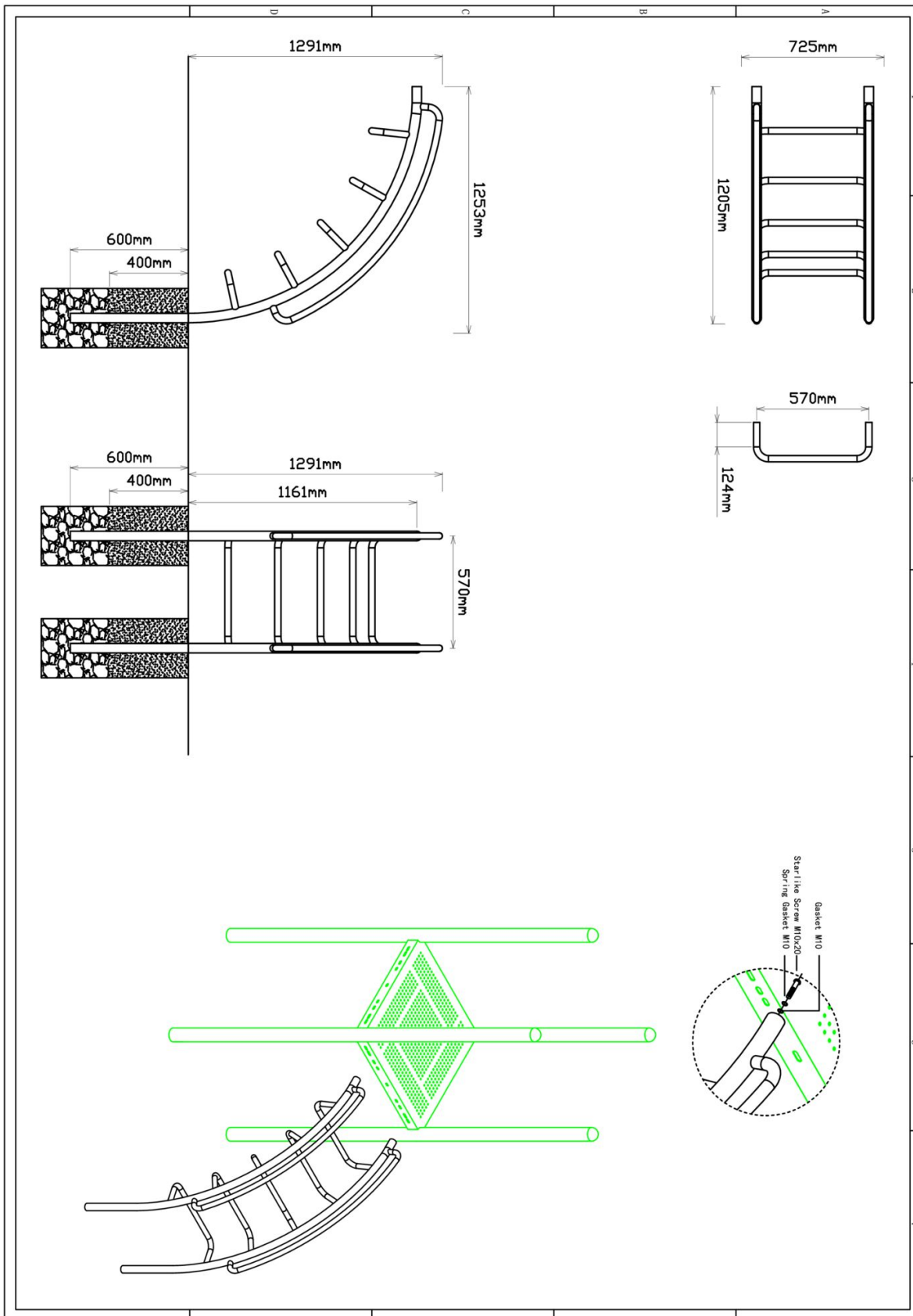

Hoofdafmetingen: 190x121x73cm



120cm Arch climber

STAP 1 van 1

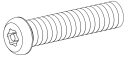
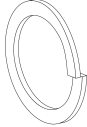
Omschrijving: Bevestiging tussen vloer en Arch climber

1 st. 120cm Arch climber	2 st. Torx M10X20	2 st. Veerring M10	2 st. Ring M10 (middel)
			

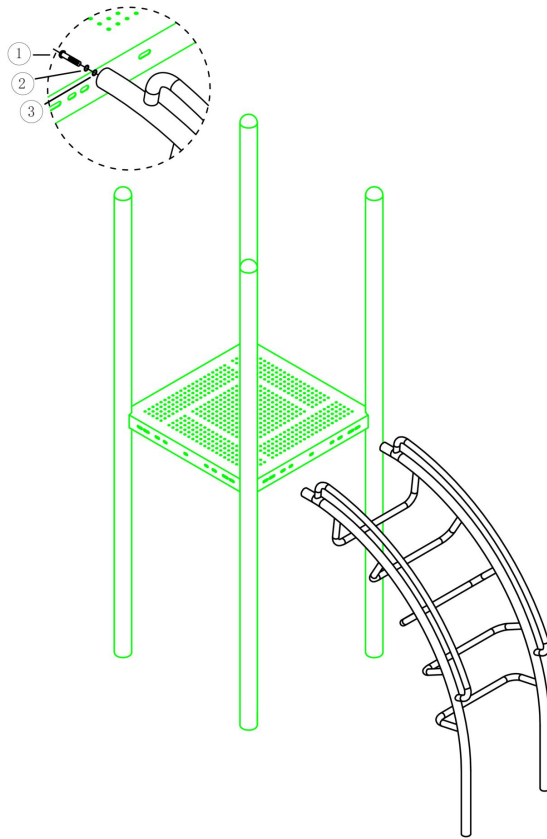





Bevestigings materiaal is per zakje verpakt en bovenstaande afbeelding zit in het zakje

Hekje tbv: B, Pod en Curly Climber

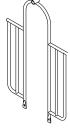
STAP 1 van 1

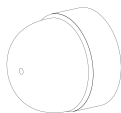
Omschrijving: Bevestiging van het hek tussen de vloer/staander

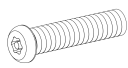
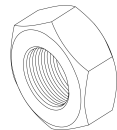
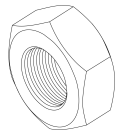
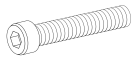
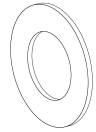
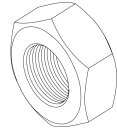
1 st. Hekje tbv: B, Pod en Curly Climber	2 st. Small clamp + ring	2 st. Afdekdop M10	2 st. Kruiskop M6X65
			① 
4 st. Torx M8X20	4 st. Lock Moer M8	2 st. Lock Moer M6	2 st. Bout M10X25
② 	③ 	④ 	⑤ 
4 st. Ring M10 (middel)	2 st. Lock Moer M10		
⑥ 	⑦ 		

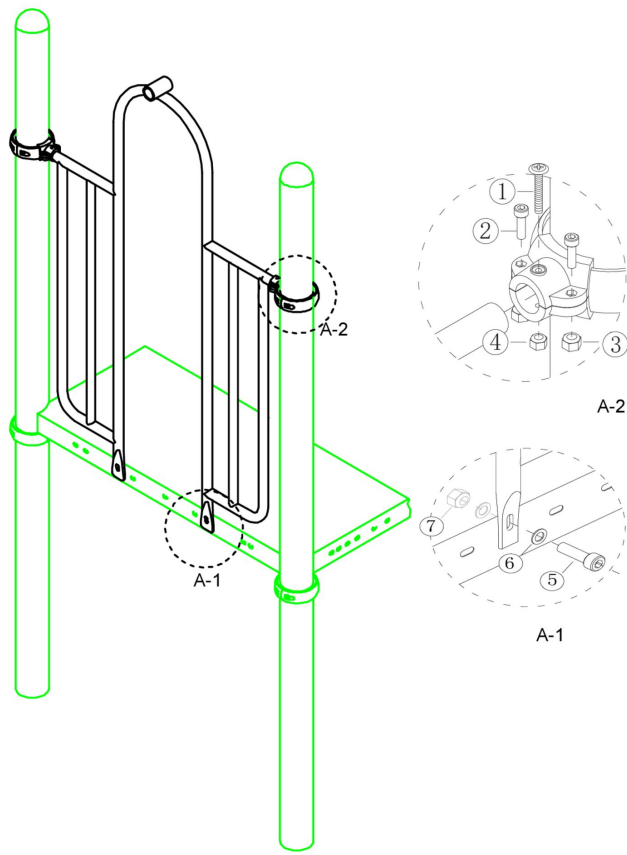

Bevestigings materiaal is per zakje verpakt en bovenstaande afbeelding zit in het zakje

120cm B climber

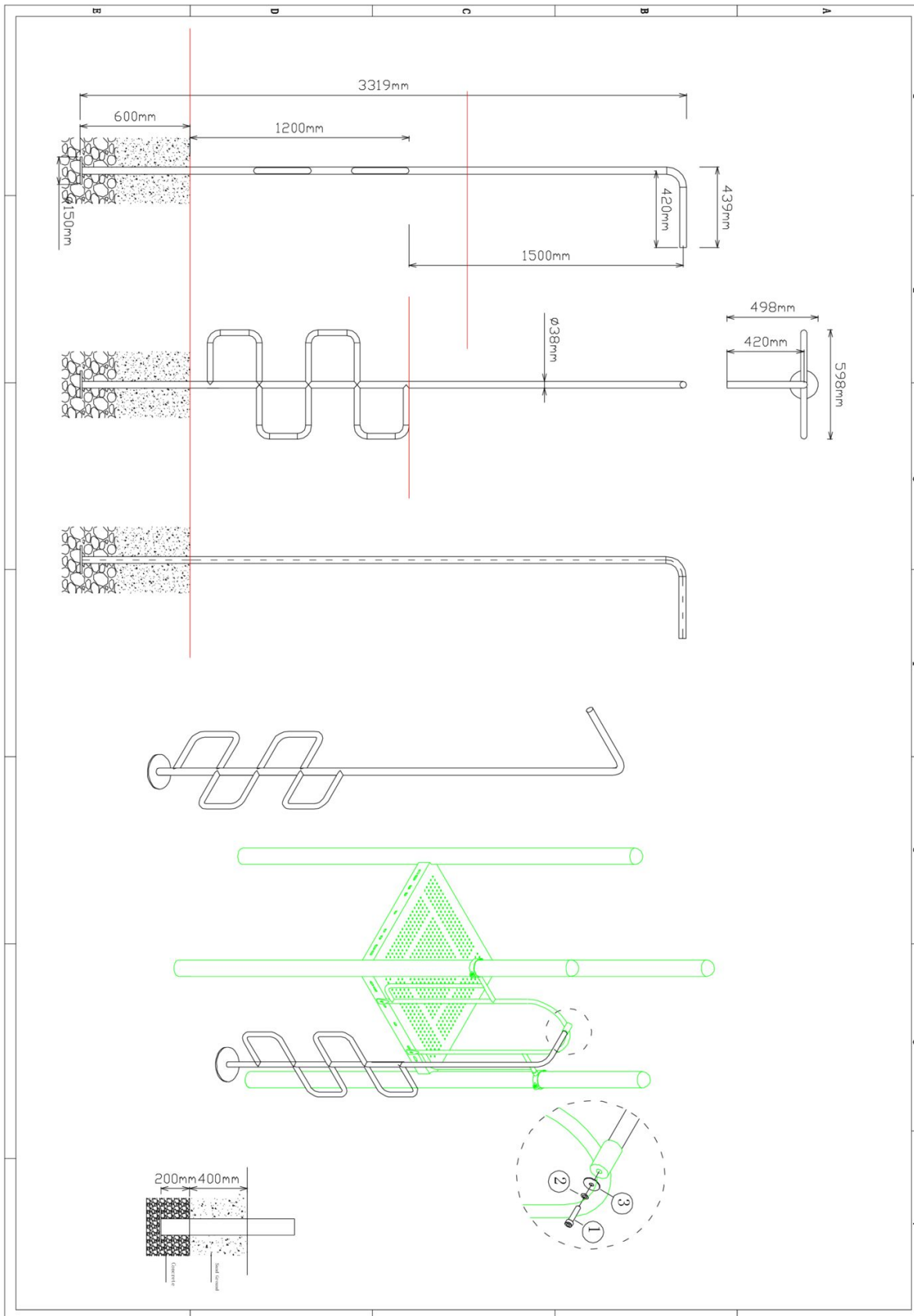

Hoofdafmetingen: 332x44cm



120cm B climber

STAP 1 van 1

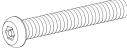
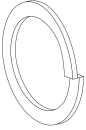
Omschrijving: Bevestiging tussen B-climber en hek

1 st. 120cm B climber	1 st. Torx M10X30	1 st. Veerring M10	1 st. Ring M10 (middel)
			

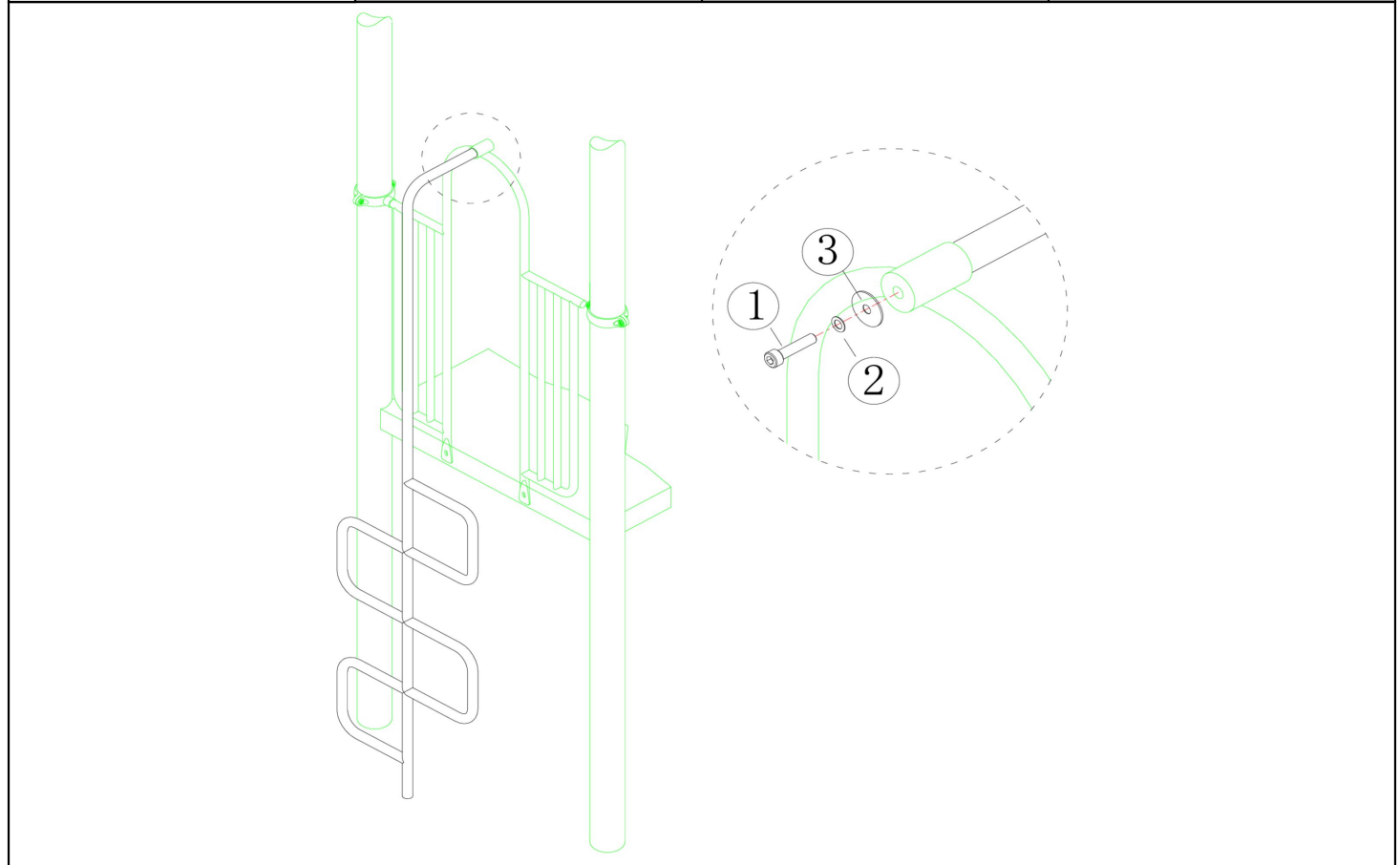







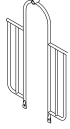

Bevestigings materiaal is per zakje verpakt en bovenstaande afbeelding zit in het zakje

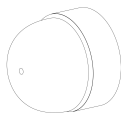
Hekje tbv glijstang

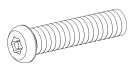
STAP 1 van 1

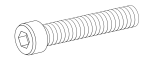
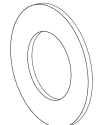
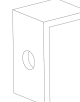
Omschrijving: Bevestiging van het hek tussen de vloer/staander

1 st. Hekje tbv glijstang	2 st. Small clamp + ring	2 st. Afdekdop M10	2 st. Kruiskop M6X65
			
4 st. Torx M8X20	4 st. Lock Moer M8	2 st. Lock Moer M6	2 st. Bout M10X25
			
4 st. Ring M10 (middel)	2 st. Hoekje	2 st. Lock Moer M10	
			

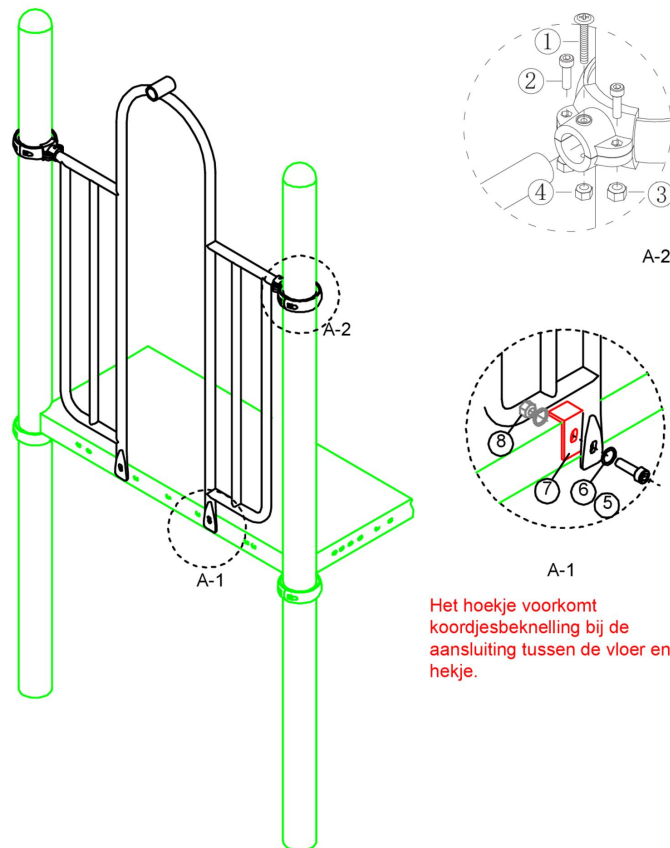

Het hoekje voorkomt koordjesbeknelling bij de aansluiting tussen de vloer en het hekje.

Bevestigings materiaal is per zakje verpakt en bovenstaande afbeelding zit in het zakje

120cm Glijstang

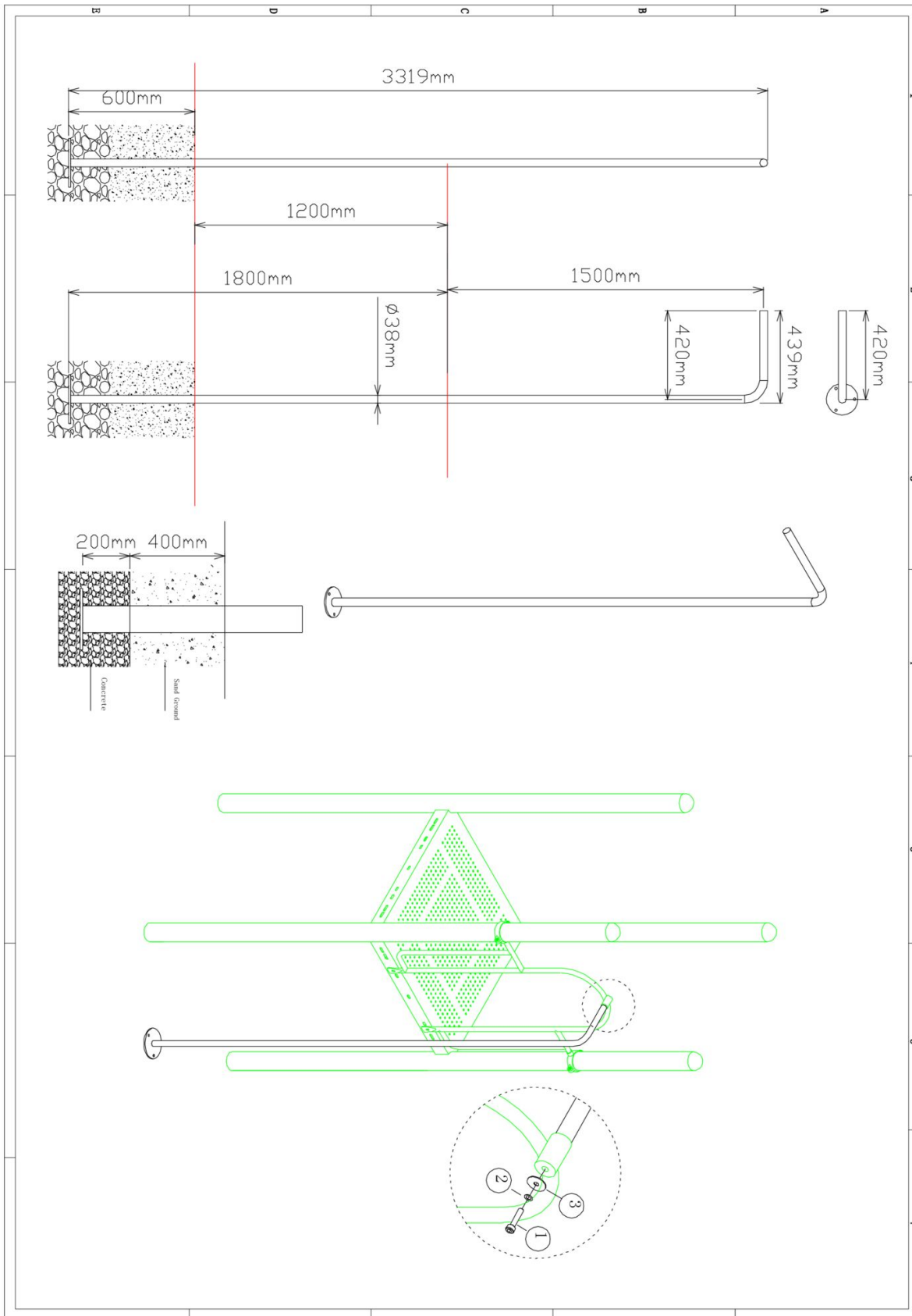

Hoofdafmetingen: 332x42



120cm Glijstang

STAP 1 van 1

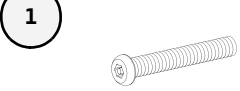
Omschrijving: Bevestiging tussen de glijstang en het hek

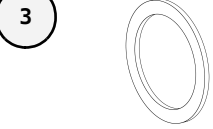
1 st. 120cm Glijstang	1 st. Torx M10X30	1 st. Veerring M10	1 st. Ring M10 (groot)
			

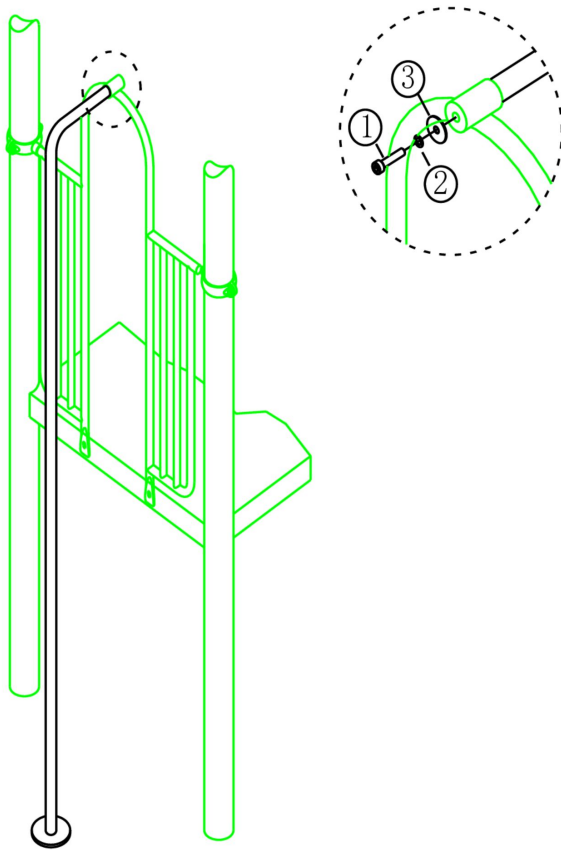

Bevestigings materiaal is per zakje verpakt en bovenstaande afbeelding zit in het zakje

Glijbaanpaneel HPL

Hoofdafmetingen: 120x98x2 cm

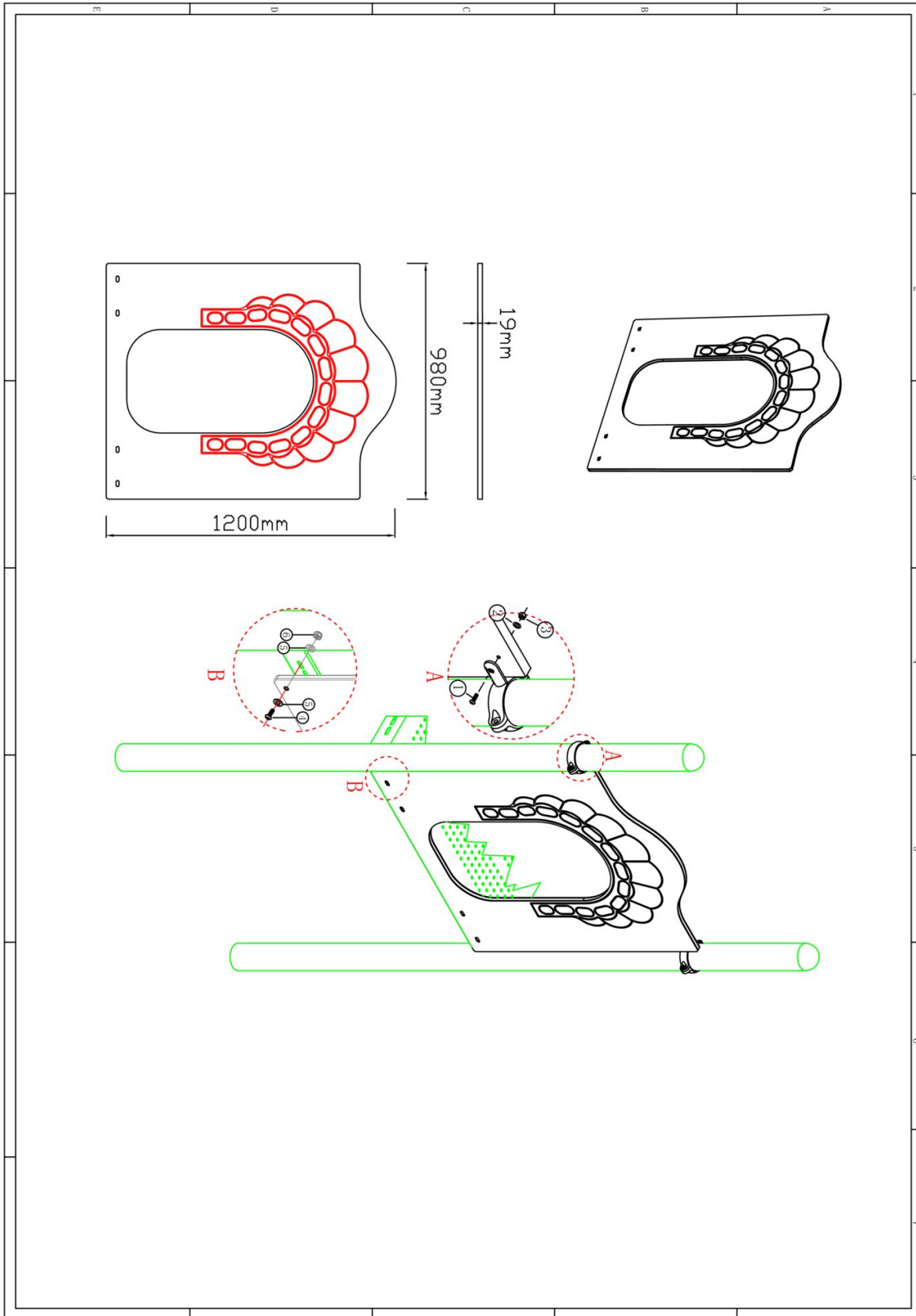

Glijbaanpaneel HPL

STAP 1 van 1

Omschrijving: Bevestiging tussen het glijbaanpaneel en de vloer / standers

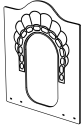
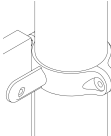
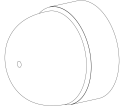
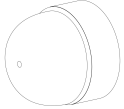
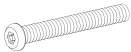
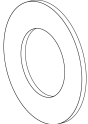
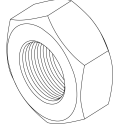
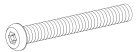
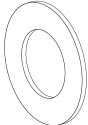
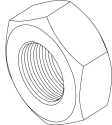
1 st. Glijbaanpaneel HPL	2 st. PE-Klem	2 st. Afdekdop M8	2 st. Afdekdop M10
			
2 st. Torx M8X35	2 st. Ring M8 (middel)	2 st. Lock Moer M8	2 st. Torx M10X35
1 	2 	3 	4 
4 st. Ring M10 (middel)	2 st. Lock Moer M10		
5 	6 		

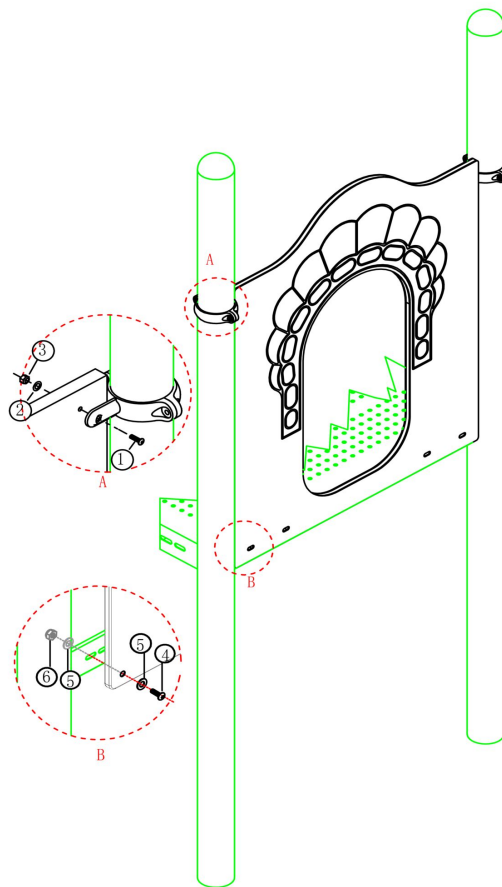

Bevestigings materiaal is per zakje verpakt en bovenstaande afbeelding zit in het zakje

120cm glijbaan recht



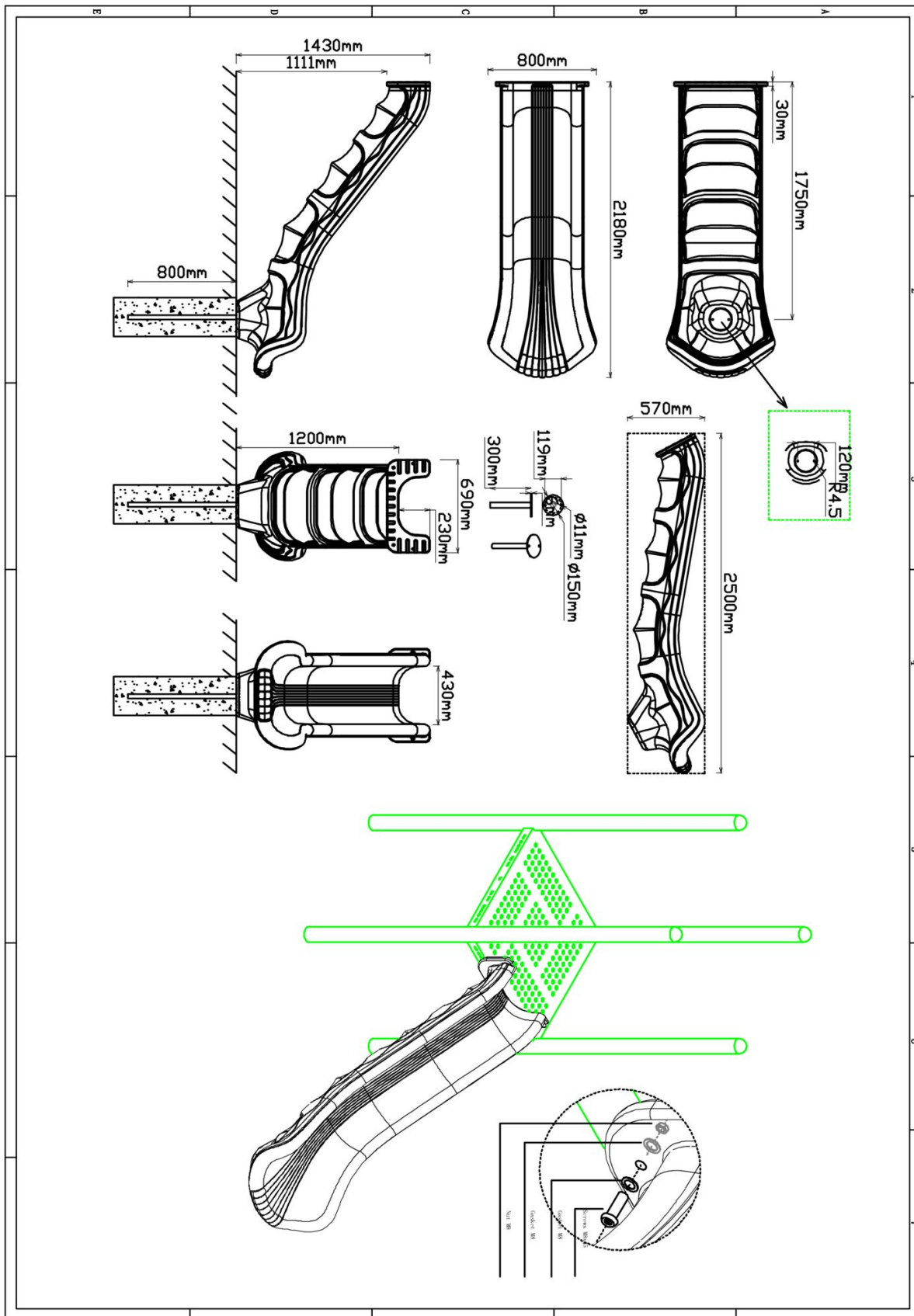

Hoofdafmetingen: 250x80x57cm

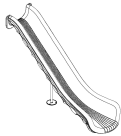
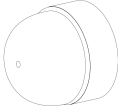

120cm glijbaan recht

STAP 1 van 2

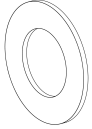
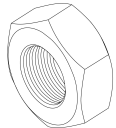
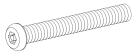
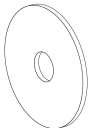
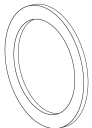
Omschrijving: Glijbaan aan de vloer en het paneel bevestigen

1 st. 120cm glijbaan recht	2 st. Afdekdop M10	2 st. Torx M10X45	4 st. Ring M10 (middel)
			
2 st. Lock Moer M10	2 st. Torx M8X35	2 st. Ring M8 (klein)	2 st. Ring M12 (groot)
			
2 st. Torx Spiraalbout M12			
			

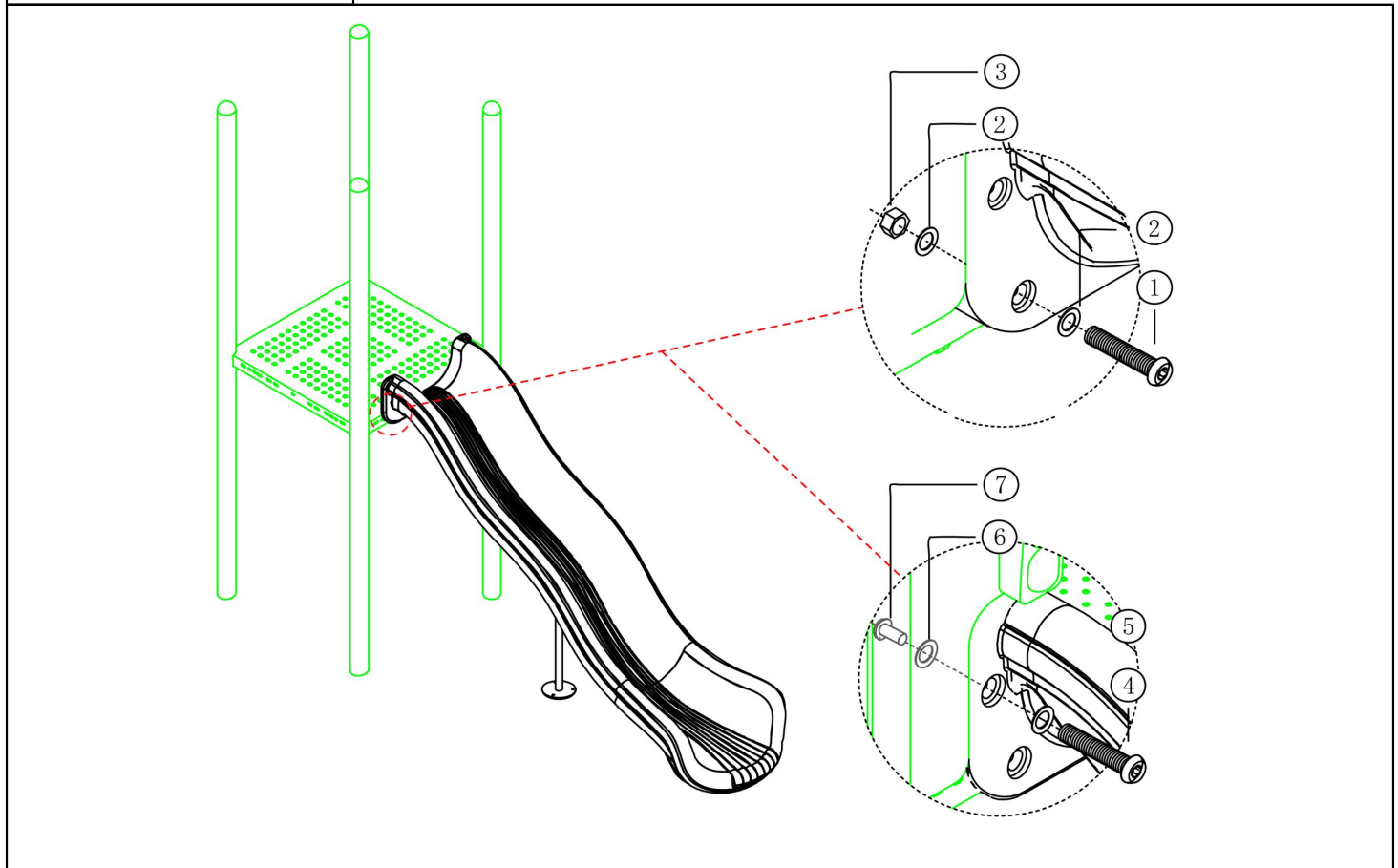

Bevestigings materiaal is per zakje verpakt en bovenstaande afbeelding zit in het zakje

120cm glijbaan recht

STAP 2 van 2

Omschrijving: Voorkom vinger- en koordjesbeknelling bij de glijbaanaansluiting. Zorg ervoor dat er geen kieren en naden zitten tussen de vloer/glijbaanpaneel en de glijbaan. Oplossen door de naden af te dichten met blanke kit die meegeleverd is.

1 st. Kitspuit

1

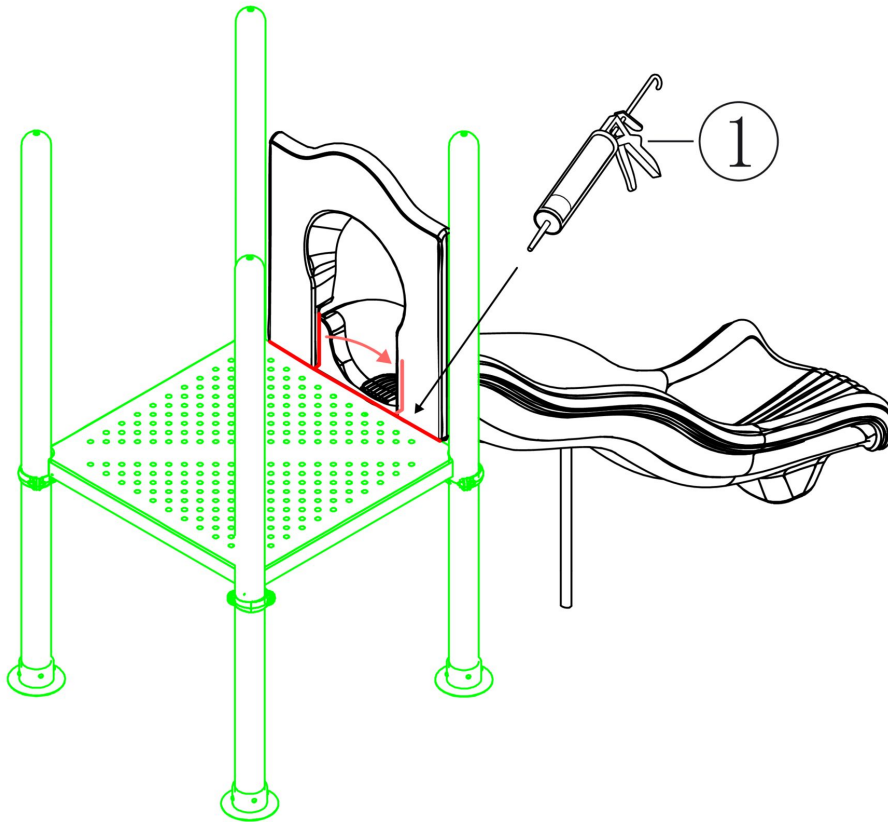
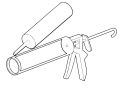

Bevestigings materiaal is per zakje verpakt en bovenstaande afbeelding zit in het zakje

Glijbaanvoet voorkant

Hoofdafmetingen: 30x15cm

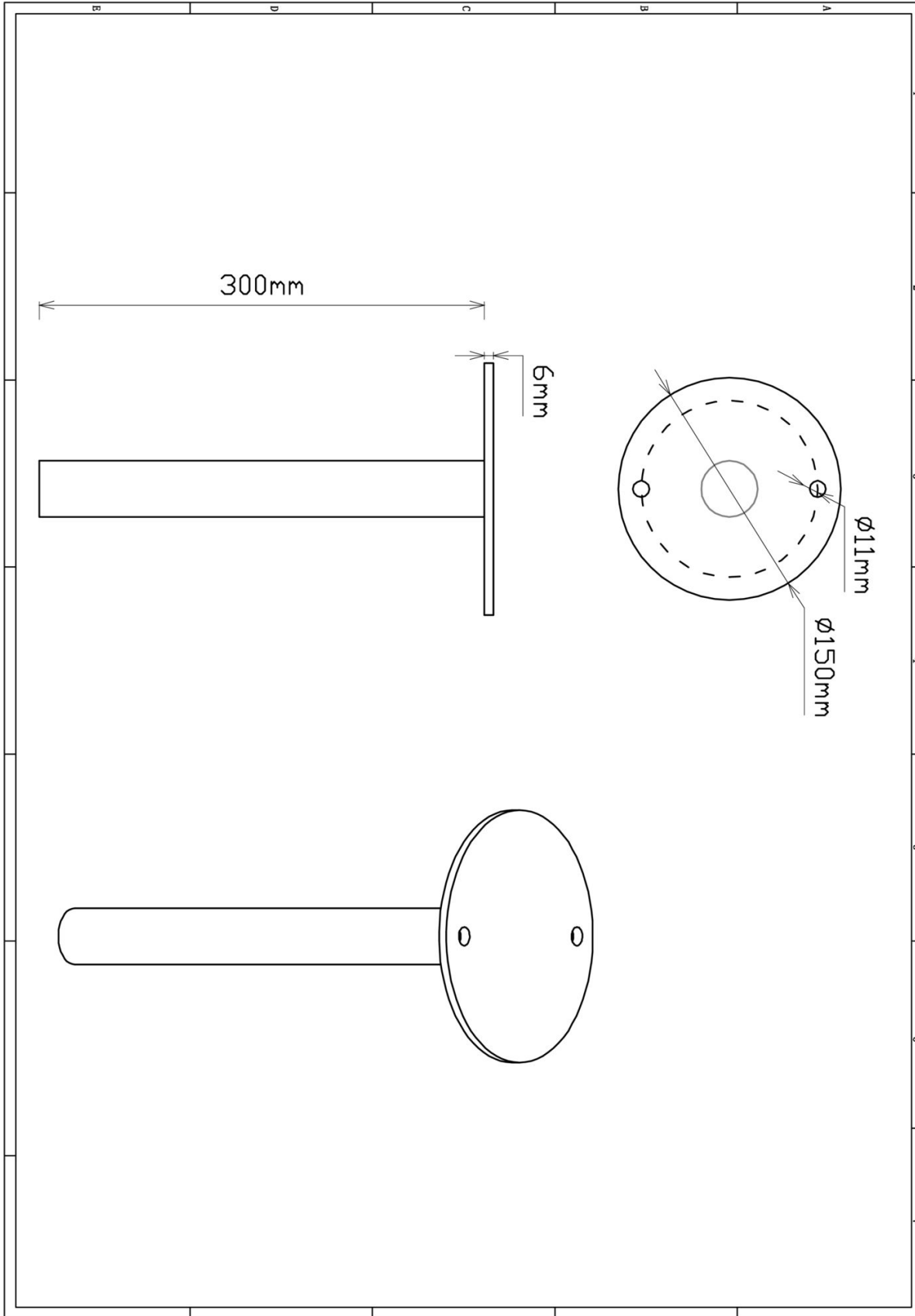

Glijbaanvoet voorkant

STAP 1 van 1

Omschrijving: Bevestiging van de voet onder de glijbaan

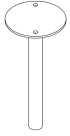
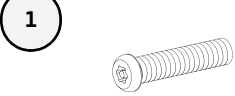
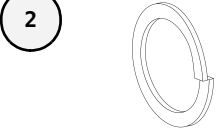
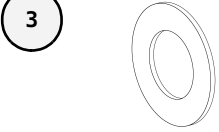
1 st. Glijbaanvoet voorkant	2 st. Torx M8X20	2 st. Veerring M8	2 st. Ring M8 (middel)
			

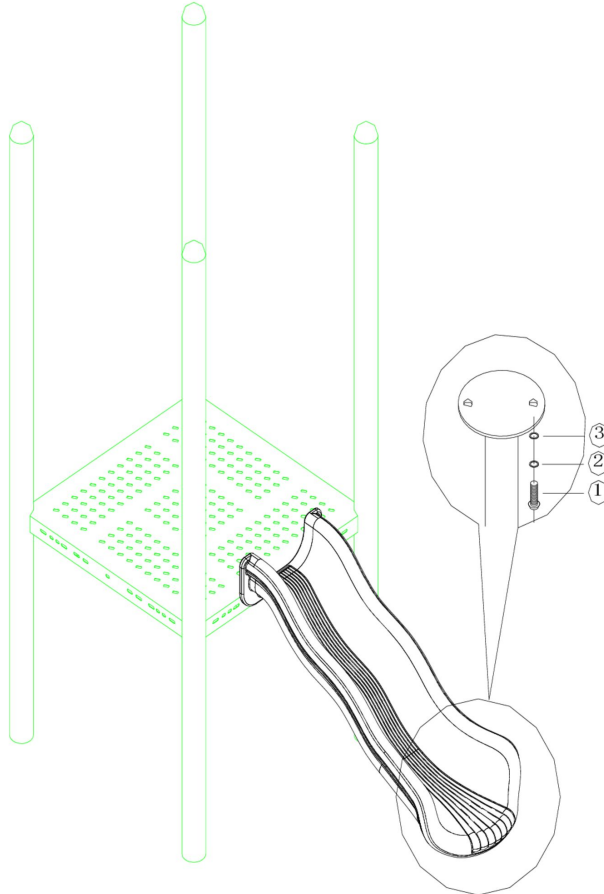

Bevestigings materiaal is per zakje verpakt en bovenstaande afbeelding zit in het zakje