

TnT speeltoestellen

Montagehandleiding

C-222



Toestel	C-222
Datum montagehandleiding	21-05-2026

Beste klant van TnT Speeltoestellen,

Wij danken u voor het aanschaffen en installeren van een speeltoestel van TnT Speeltoestellen.
Wij waarderen het vertrouwen dat u in ons bedrijf heeft geplaatst en streven ernaar om uw vertrouwen meer dan waar te maken!

Dit is uw TnT speeltoestellen montagehandleiding.

Wij hebben deze handleiding specifiek voor het product ontworpen, waarop eveneens de toe te passen onderdelen zijn genoemd.

Ook vindt u het grondplan met de benodigde valruimte volgens norm NEN-EN1176-1 : 2017.

Bewaart u dit document bij uw logboek. Nogmaals willen wij u bedanken voor de aankoop van dit speeltoestel. Wij zien uit naar uw volgende speelproject.

Met vriendelijke groet, TnT Speeltoestellen

Inhoudsopgave

Aanzichten 3D	2
Onderdelenlijst	4
Veiligheidsruimtes	5
Zijaanzichten	6
Plattegrond palenplan	8
Paalmaten	9
Paaldata	10
Onderdeel handleidingen	11
Staander 350cm	12
Vloer vierkant (vloer_vierkant)	14
Metalen hekje (metalen_hekje)	16
Opgang wikkel (opgang_wikkel_150cm)	18
Glijstang (glijstang_150cm)	22
Opgang doppen (opgang_doppen_150cm)	26
Glijbaan kunststof recht (glijbaan_enkel_recht_150cm)	30
Bankje (bankje)	39

Aanzichten 3D



Aanzicht 1



Aanzicht 2

Aanzichten 3D









Aanzicht 3

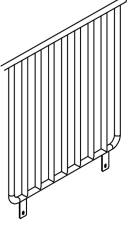
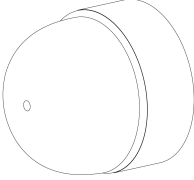
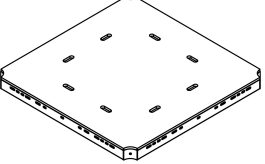
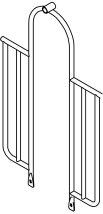

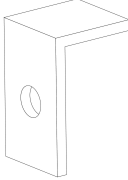
Aanzicht 4

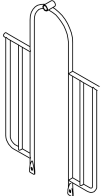
Onderdelenlijst

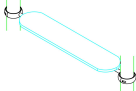
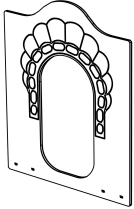
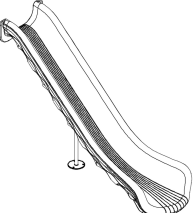
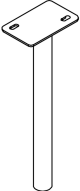
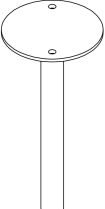
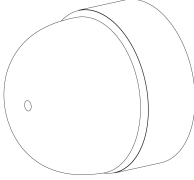
<p>6x Staander 350cm 350x11,5cm</p>	<p>2x Balustrade metaal 105x101cm</p>	<p>14x Afdekdop M10 M10</p>	<p>2x Vloer vierkant HPL 117x117x8,5cm</p>
			
<p>1x Hekje tbv glijstang 152x101cm</p>	<p>1x 150cm Glijstang 362x42cm</p>	<p>2x Hoekje</p>	<p>1x 150cm Pod climber 362x71cm</p>
			
<p>2x Hekje tbv: B, Pod en Curly Climber 152x101cm</p>	<p>1x 150cm Curly climber 364x67cm</p>	<p>2x Bankje 2.0 116x22x4cm</p>	<p>1x Glijbaanpaneel HPL 120x98x2 cm</p>
			
<p>1x 150cm glijbaan recht 307x82x57cm</p>	<p>1x Glijbaanvoet midden 150cm 132x16x12cm</p>	<p>1x Glijbaanvoet voorkant 30x15cm</p>	<p>18x Afdekdop M8 M8</p>
			

Veiligheidsruimtes

Geachte klant,

Zorg er altijd voor dat alle veiligheidsruimtes zoals aangegeven in ieder geval gehaald worden, dit zijn de minimale vereiste ruimtes voor een veilig gebruik van het speeltoestel.

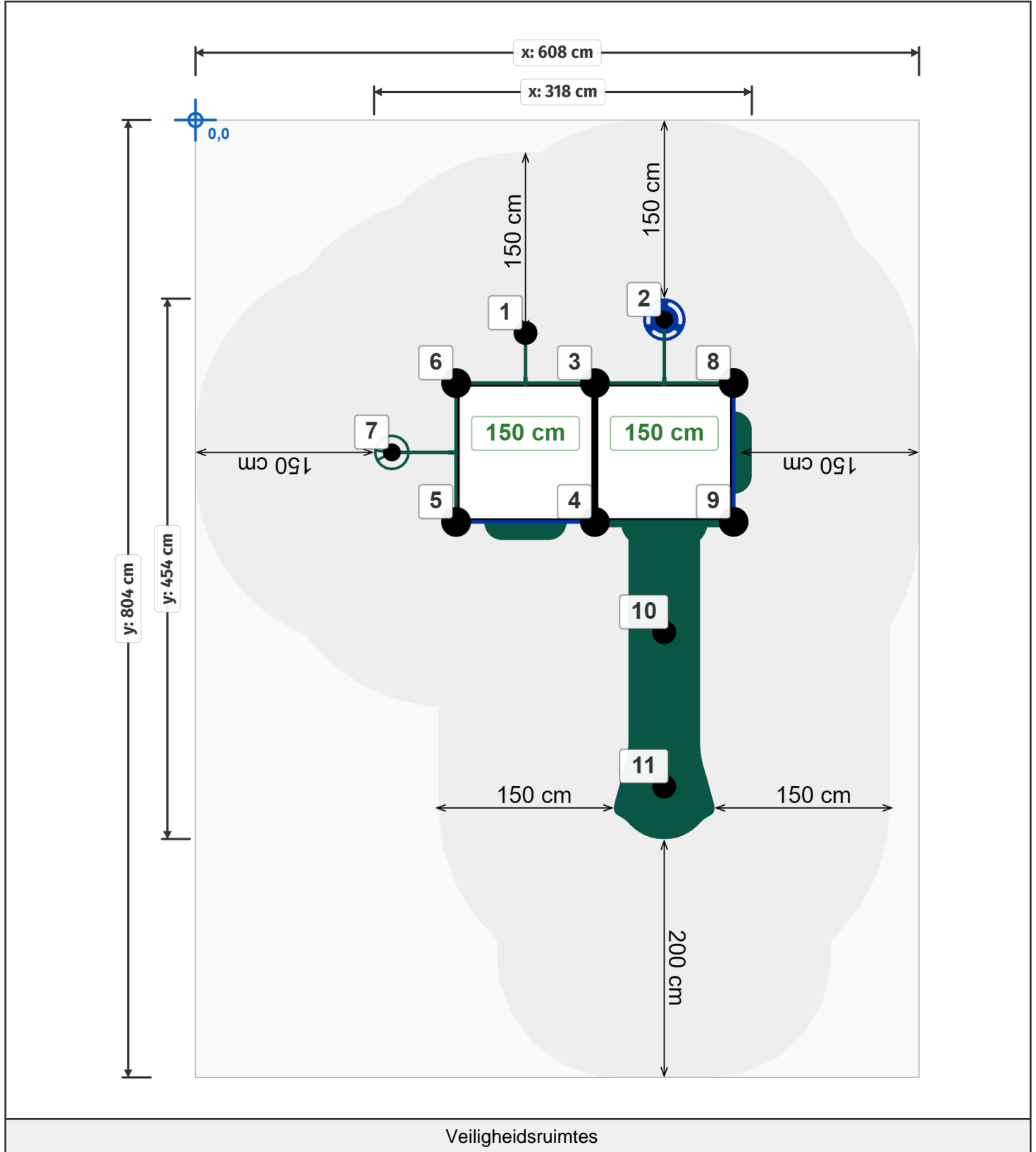

Zijaanzichten

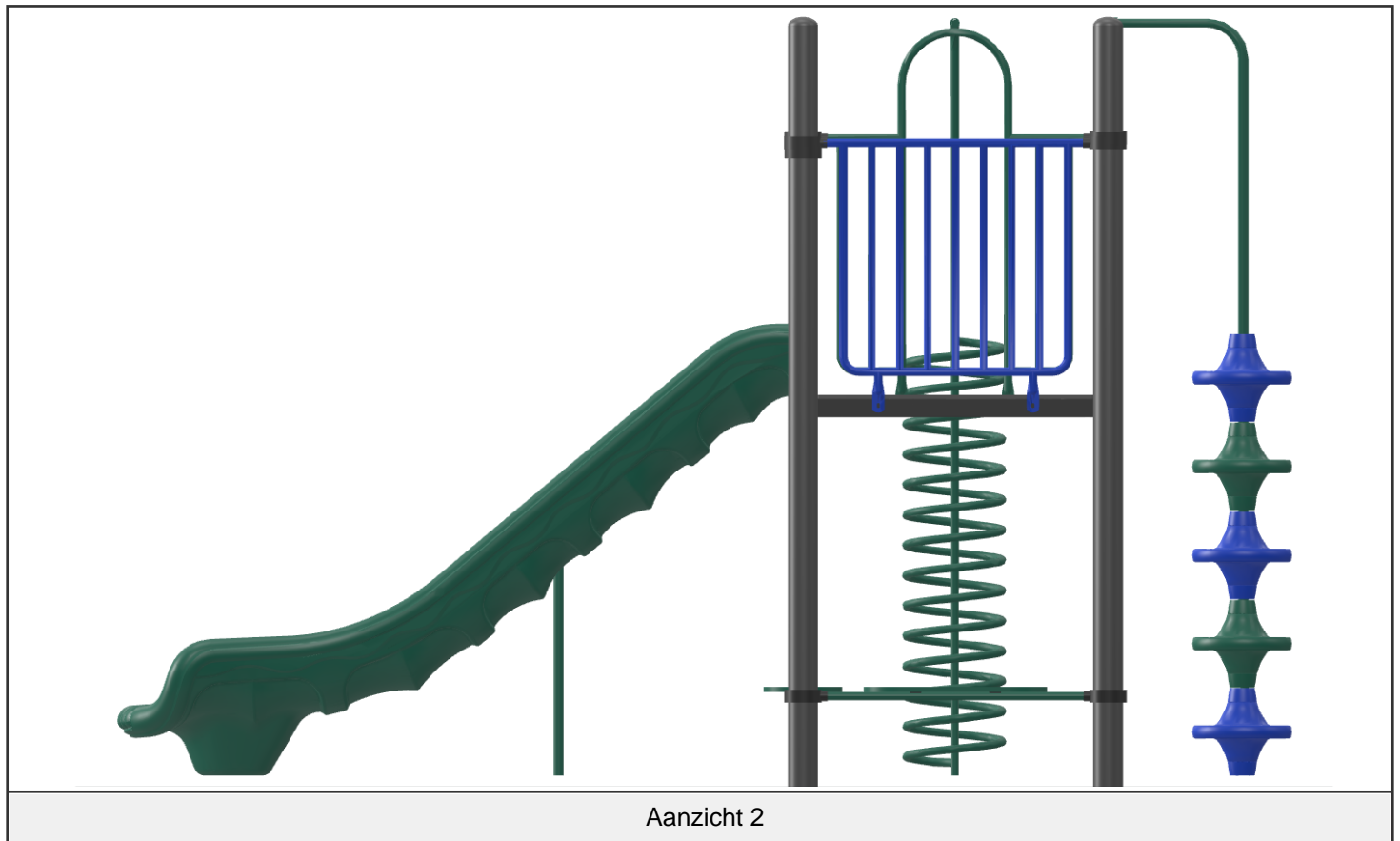
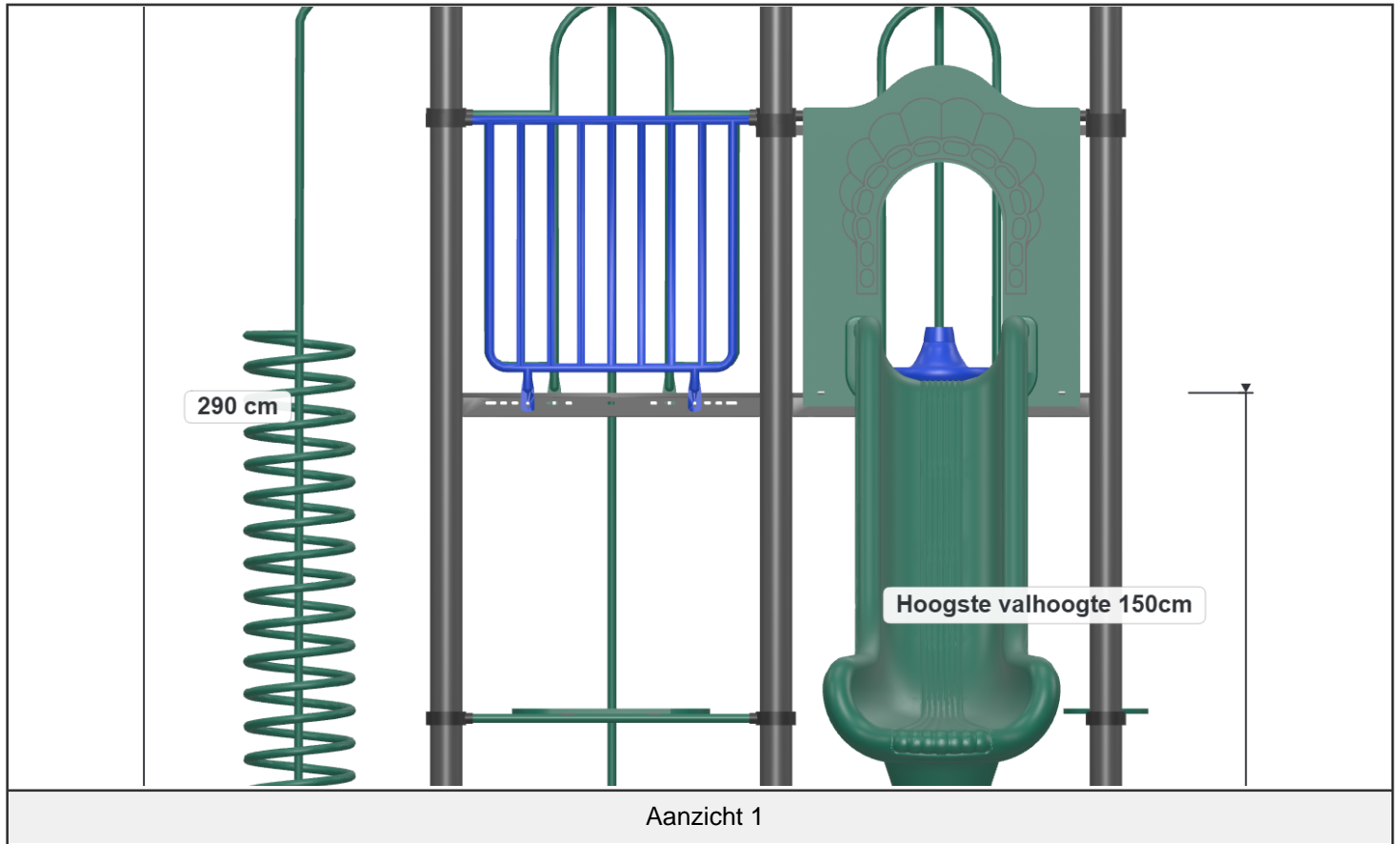

Zijaanzichten

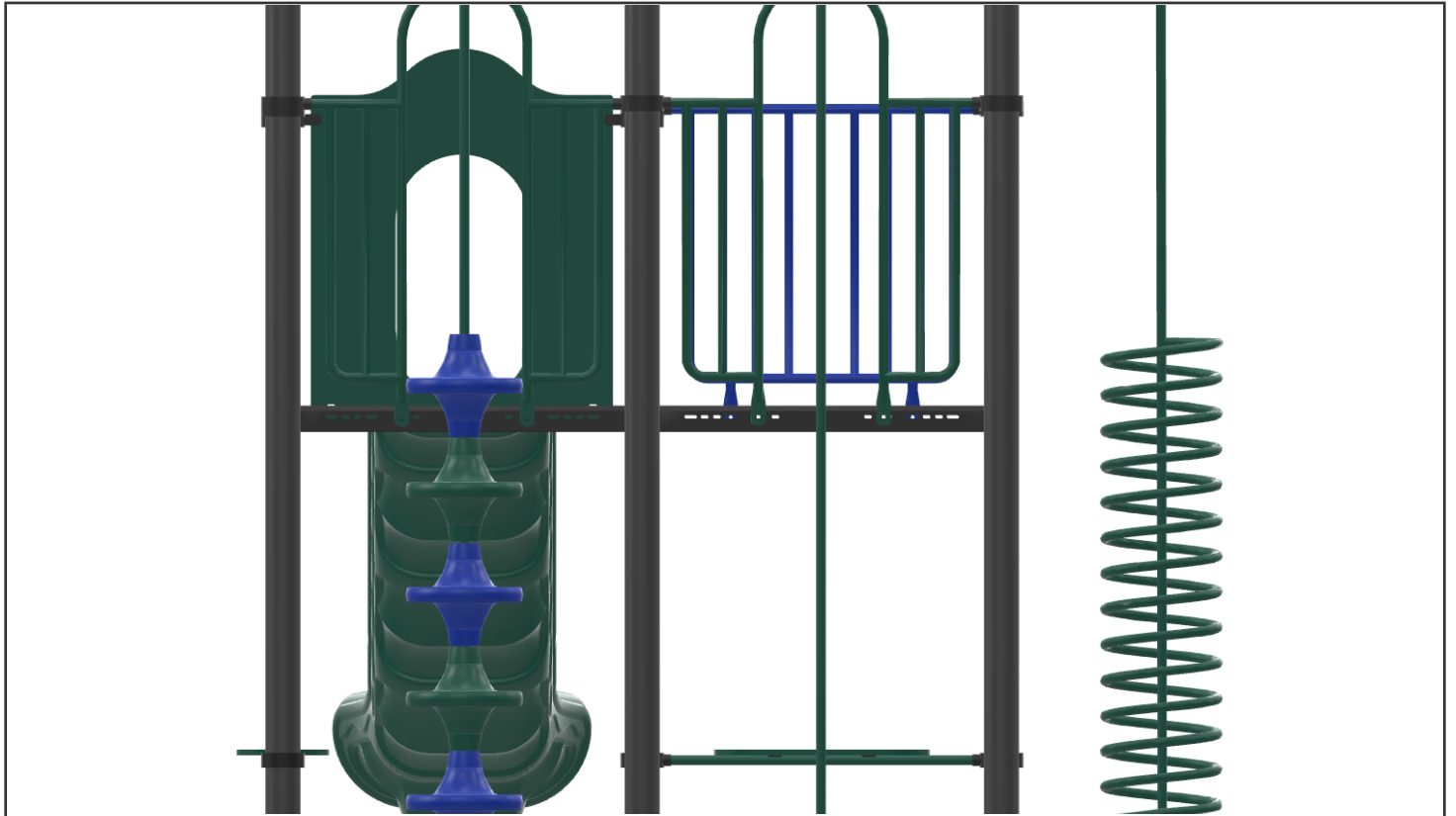

Aanzicht 3



Aanzicht 4

Plattegrond palenplan

U kunt van deze tekening niet afmeten!

Voor de betonfundatie heeft u 37,5 kg snelbeton per staander nodig.

Voor de overige onderdelen (Glijstangen, Climbers, Glijbaan voeten) 25 kg snelbeton.

Houdt u er rekening mee dat de betonfundatie minimaal 400mm onder het maaiveld blijft, zoals op de tekening afgebeeld.

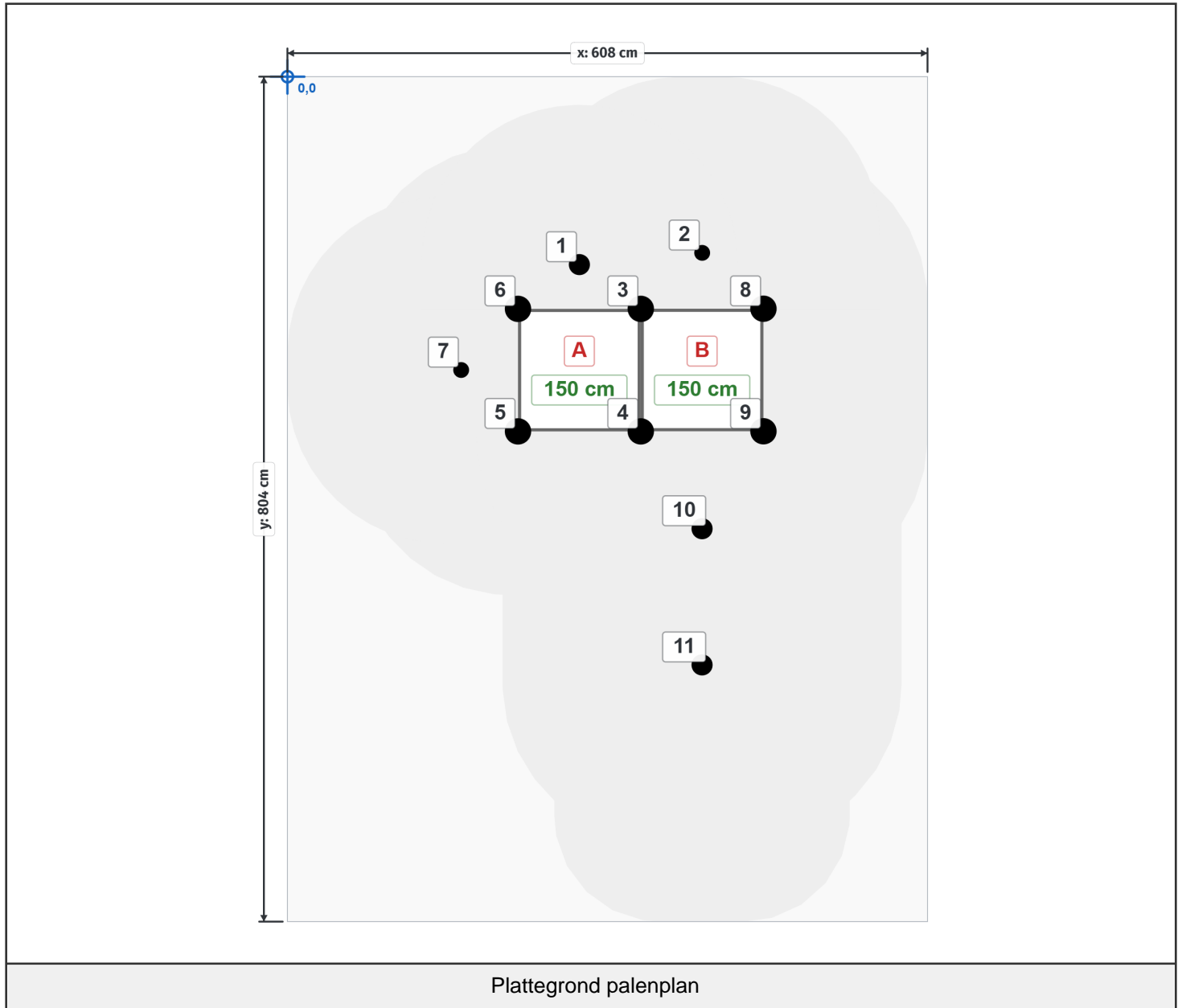

Plattegrond palenplan

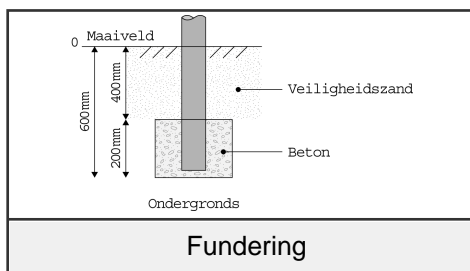

Paalmaten

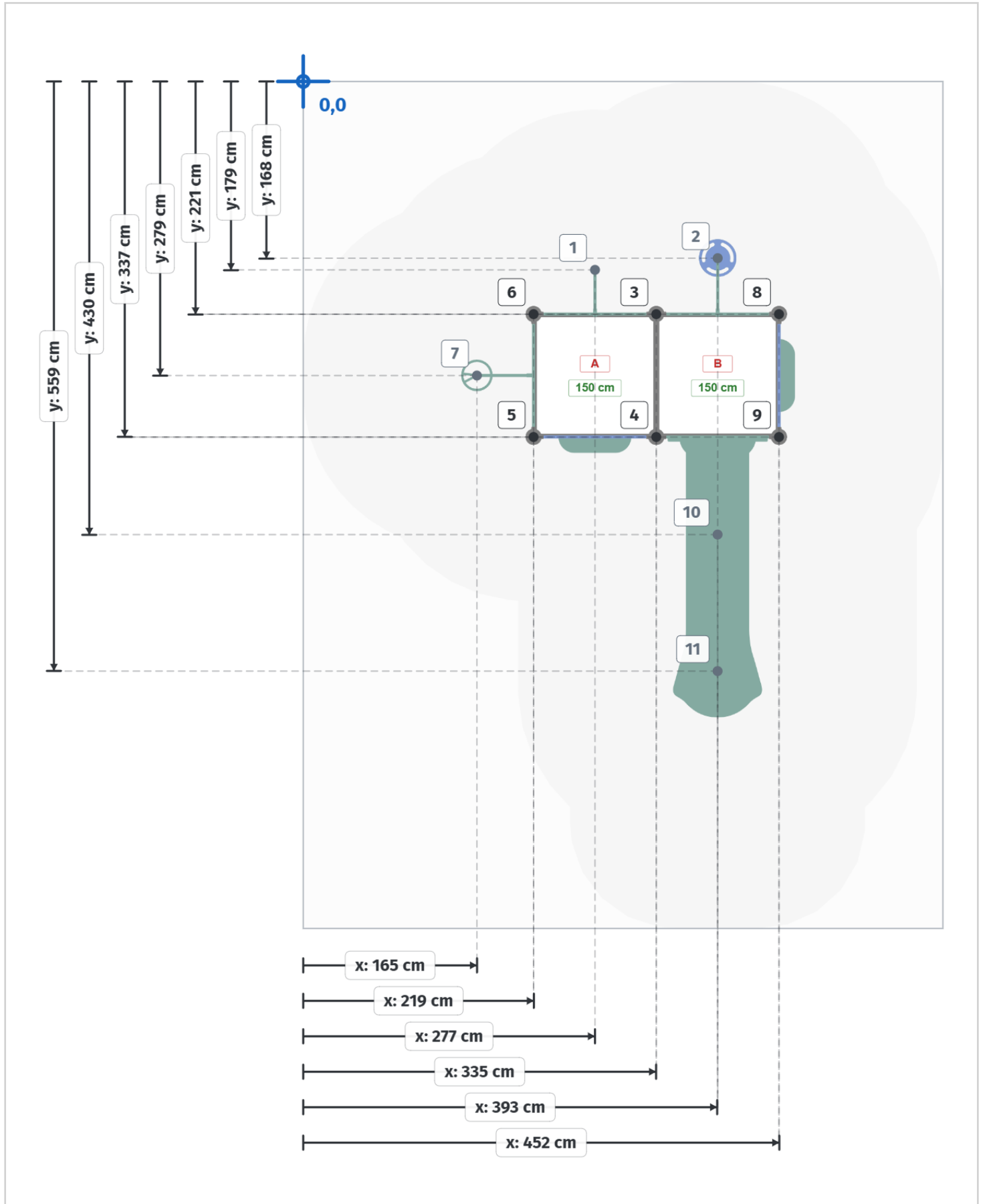

Paaldata

Staanders			
Label	X	Y	Hoogte
1	277 cm	179 cm	0 cm
2	394 cm	168 cm	0 cm
3	336 cm	221 cm	350 cm
4	336 cm	338 cm	350 cm
5	219 cm	338 cm	350 cm
6	219 cm	221 cm	350 cm
7	165 cm	279 cm	0 cm
8	452 cm	221 cm	350 cm
9	452 cm	338 cm	350 cm
10	394 cm	430 cm	0 cm
11	394 cm	560 cm	0 cm

Vloeren	
Label	Hoogte
A	150 cm
B	150 cm

Onderdeel handleidingen

Op de volgende pagina's van dit document vindt u alle individuele onderdelen met bijbehorende technische tekeningen en eventuele montage instructies.

Staander 350cm

Hoofdafmetingen: 350x11,5cm

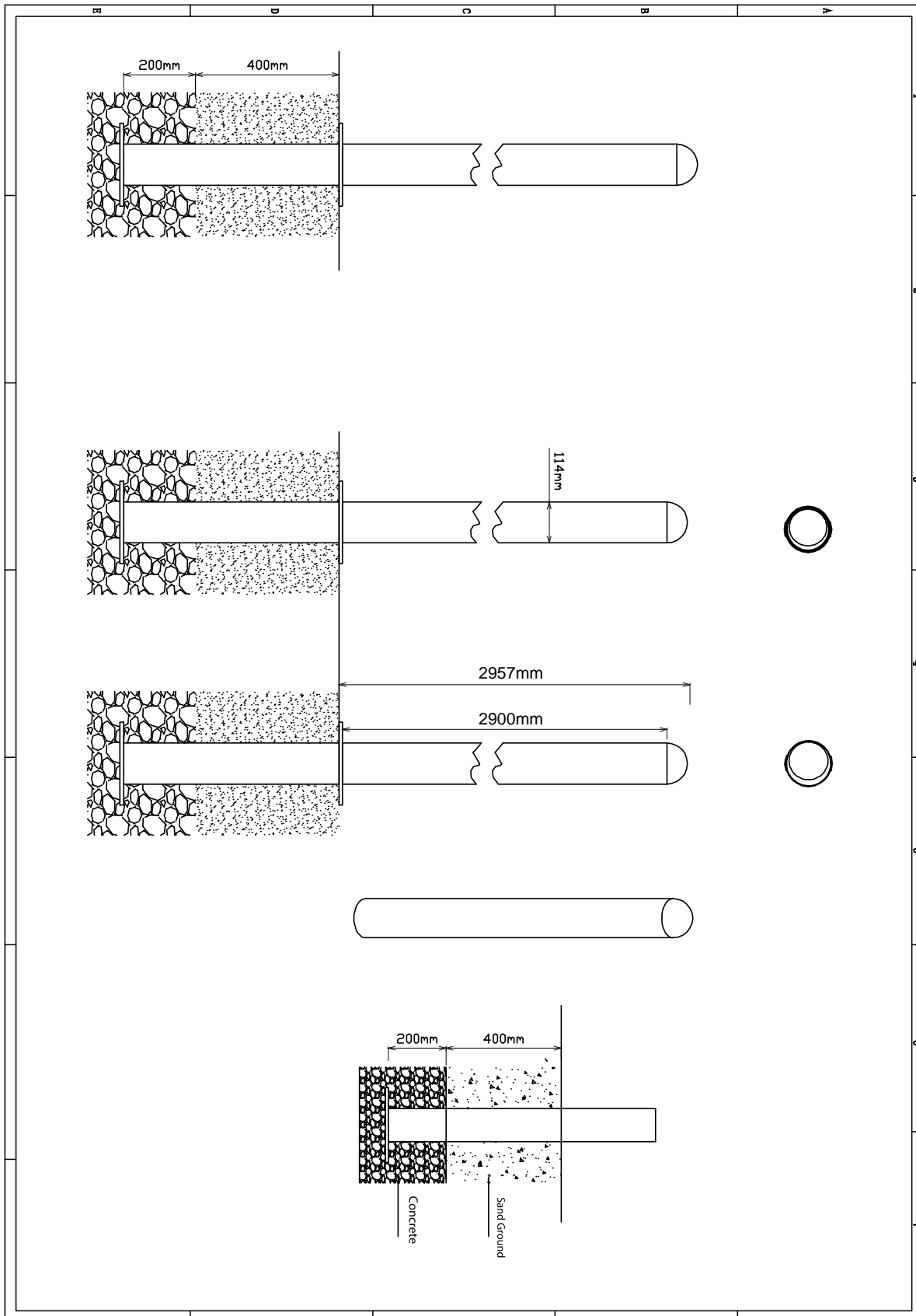

Staander

STAP 1 van 1

Omschrijving: Paalkap losdraaien en opnieuw bevestigen met loctite op het draadeind

1 st. Loctite

1

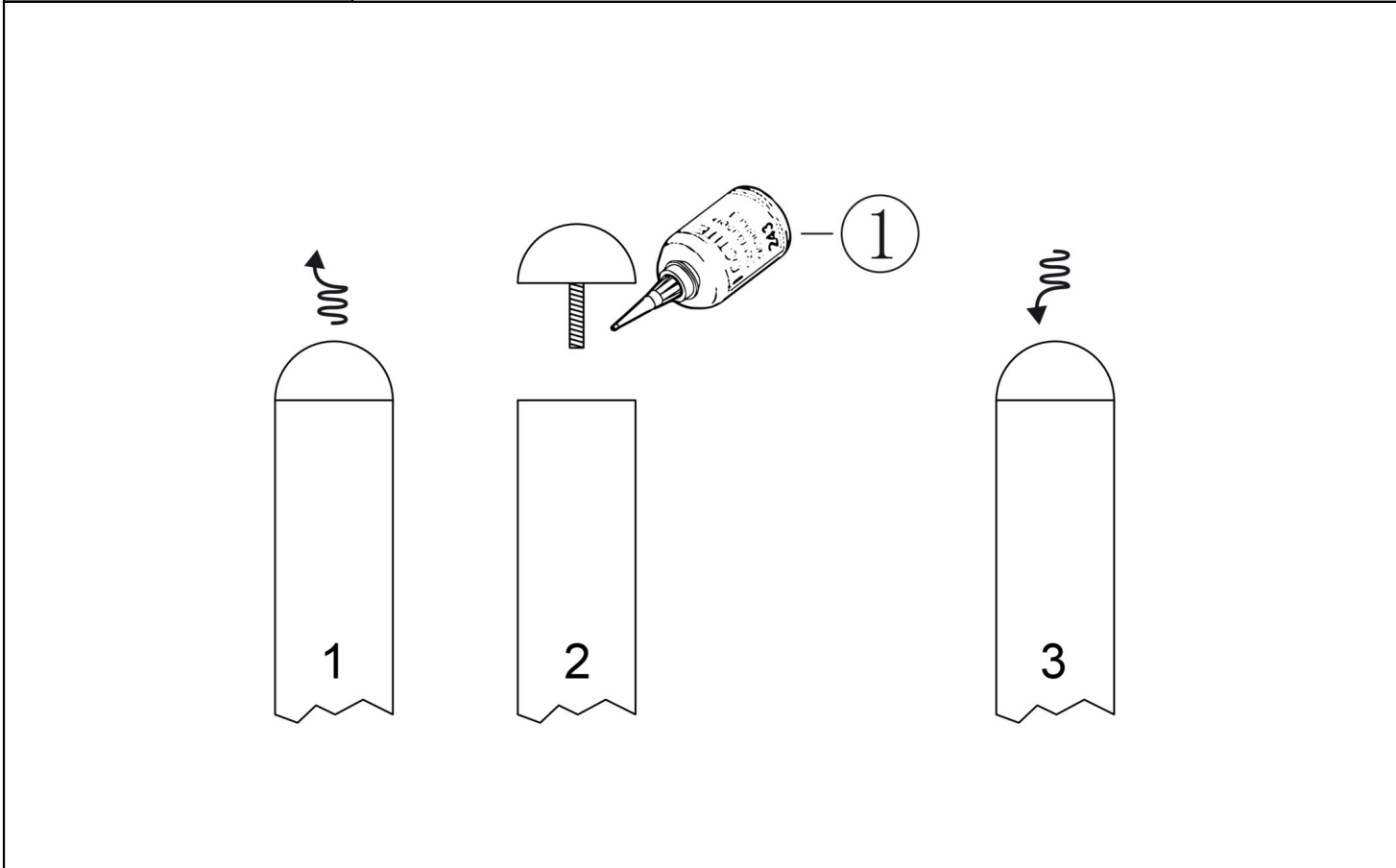

Bevestigings materiaal is per zakje verpakt en bovenstaande afbeelding zit in het zakje

Vloer vierkant HPL

Hoofdafmetingen: 117x117x8,5cm

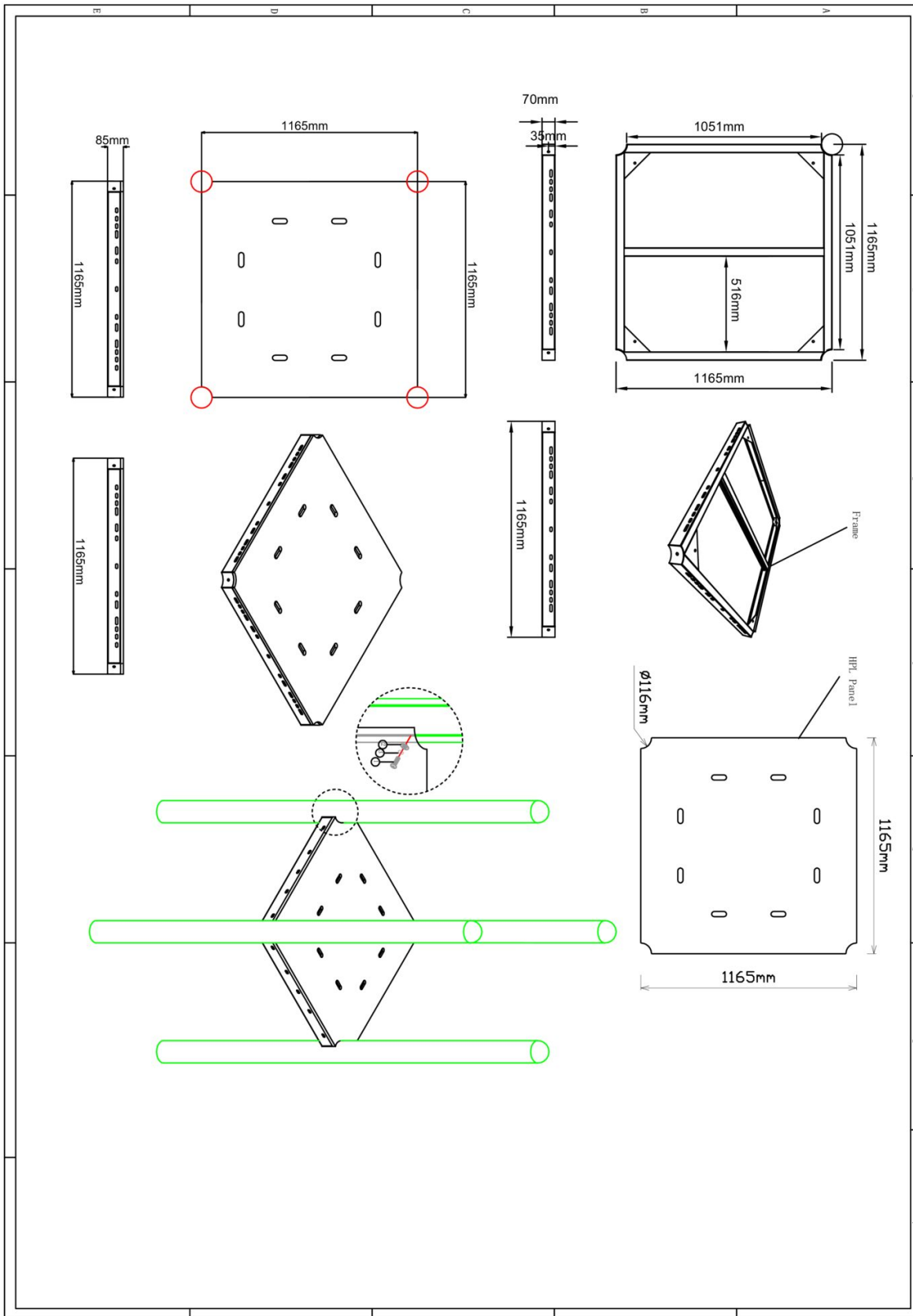

Vloer vierkant HPL

STAP 1 van 1

Omschrijving: Bevestiging van de vloer aan de staander. In de staander zitten al voor gemonteerde M10 bussen op de juiste hoogte waar de bout ingedraaid dienen te worden.

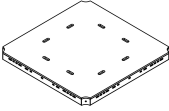
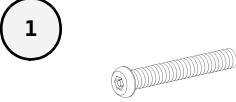
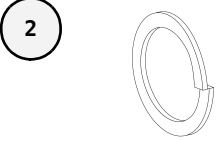
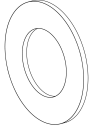
1 st. Vloer vierkant HPL	4 st. Torx M10X30	4 st. Veerring M10	4 st. Ring M10 (middel)
			

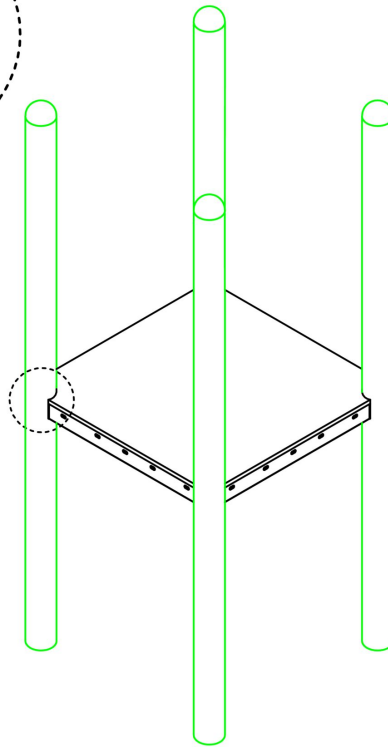
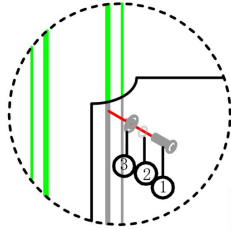

Bevestigings materiaal is per zakje verpakt en bovenstaande afbeelding zit in het zakje

Balustrade metaal



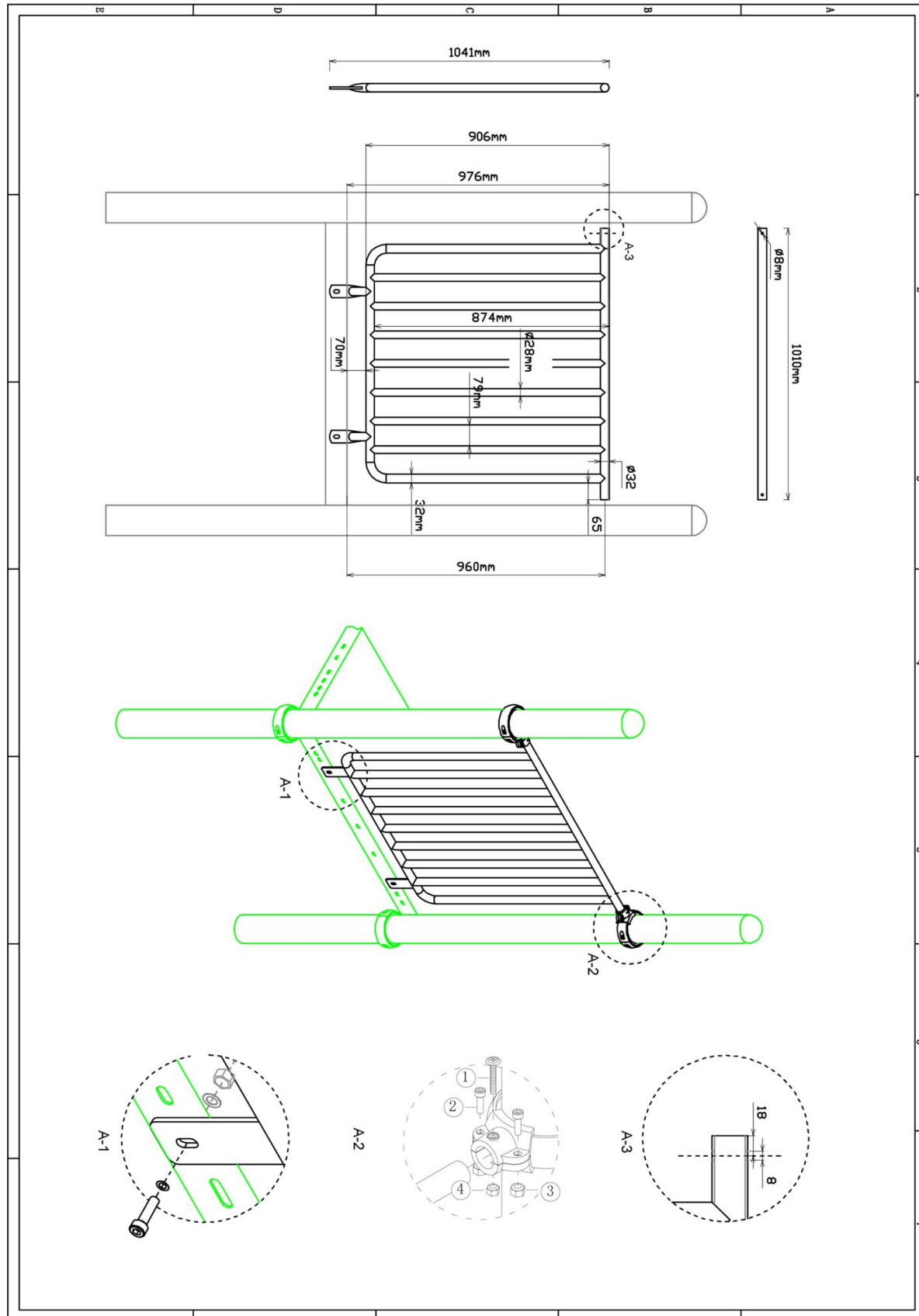



Hoofdafmetingen: 105x101cm

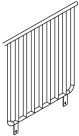

Balustrade metaal

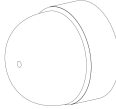
STAP 1 van 1

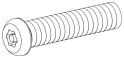
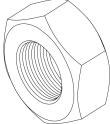
Omschrijving: Bevestiging tussen de vloer/staander

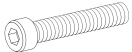
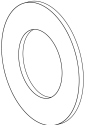
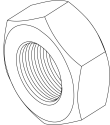
1 st. Balustrade metaal	2 st. Small clamp + ring	2 st. Afdekdop M10	2 st. Kruiskop M6X65
			1 
4 st. Torx M8X20	4 st. Lock Moer M8	2 st. Lock Moer M6	2 st. Bout M10X25
2 	3 	4 	5 
4 st. Ring M10 (middel)	2 st. Lock Moer M10		
6 	7 		

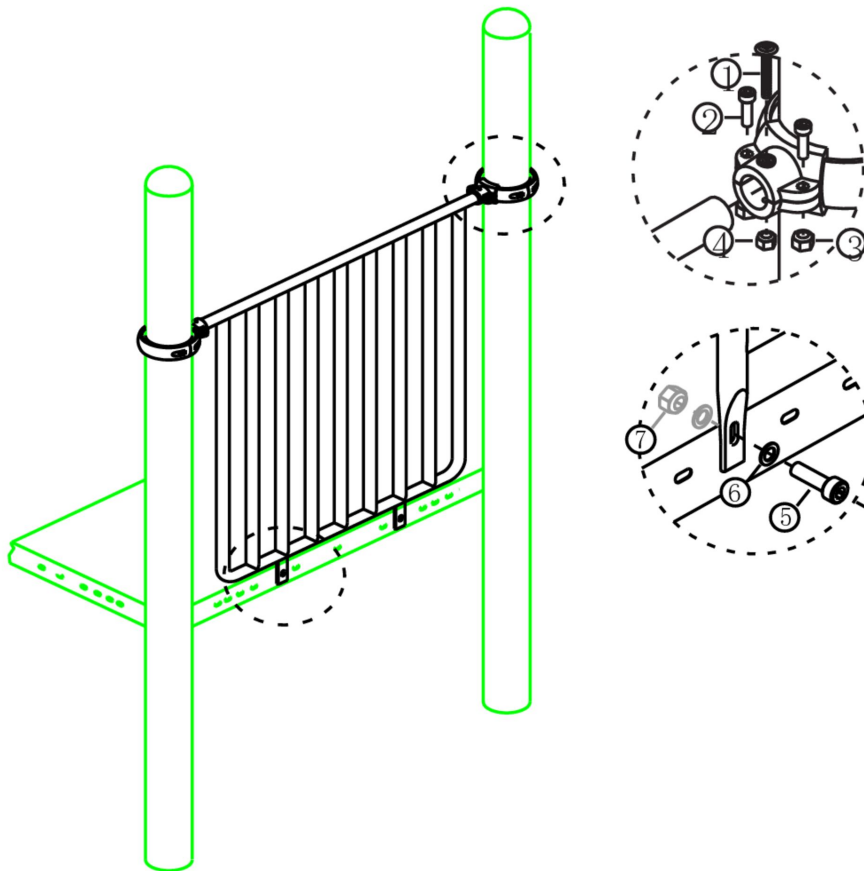





Bevestigings materiaal is per zakje verpakt en bovenstaande afbeelding zit in het zakje

Hekje tbv: B, Pod en Curly Climber

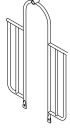
STAP 1 van 1

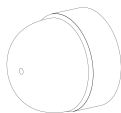
Omschrijving: Bevestiging van het hek tussen de vloer/staander

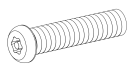
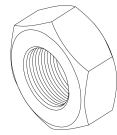
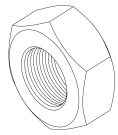
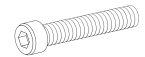
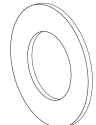
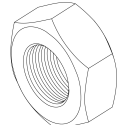
1 st. Hekje tbv: B, Pod en Curly Climber	2 st. Small clamp + ring	2 st. Afdekdop M10	2 st. Kruiskop M6X65
			① 
4 st. Torx M8X20	4 st. Lock Moer M8	2 st. Lock Moer M6	2 st. Bout M10X25
② 	③ 	④ 	⑤ 
4 st. Ring M10 (middel)	2 st. Lock Moer M10		
⑥ 	⑦ 		

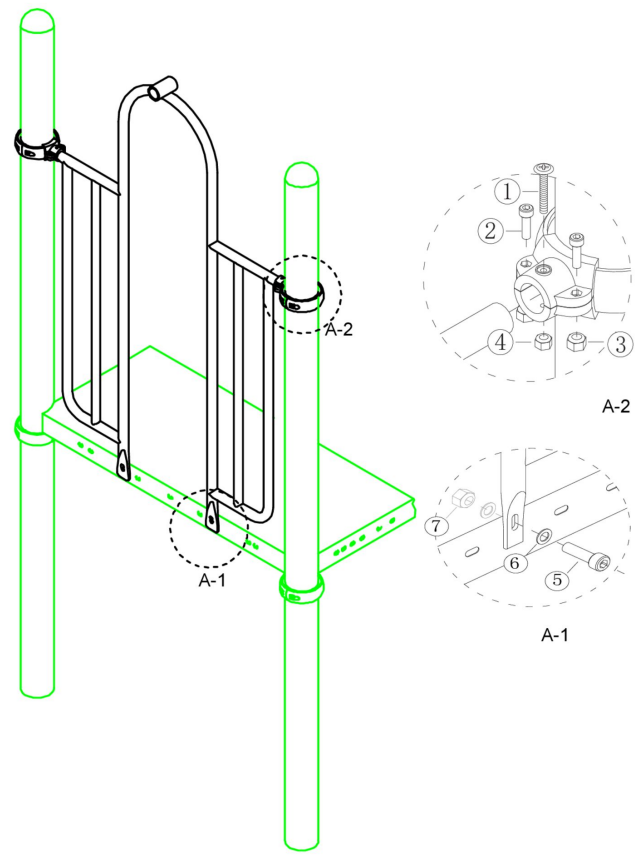

Bevestigings materiaal is per zakje verpakt en bovenstaande afbeelding zit in het zakje

150cm Curly climber

Hoofdafmetingen: 364x67cm

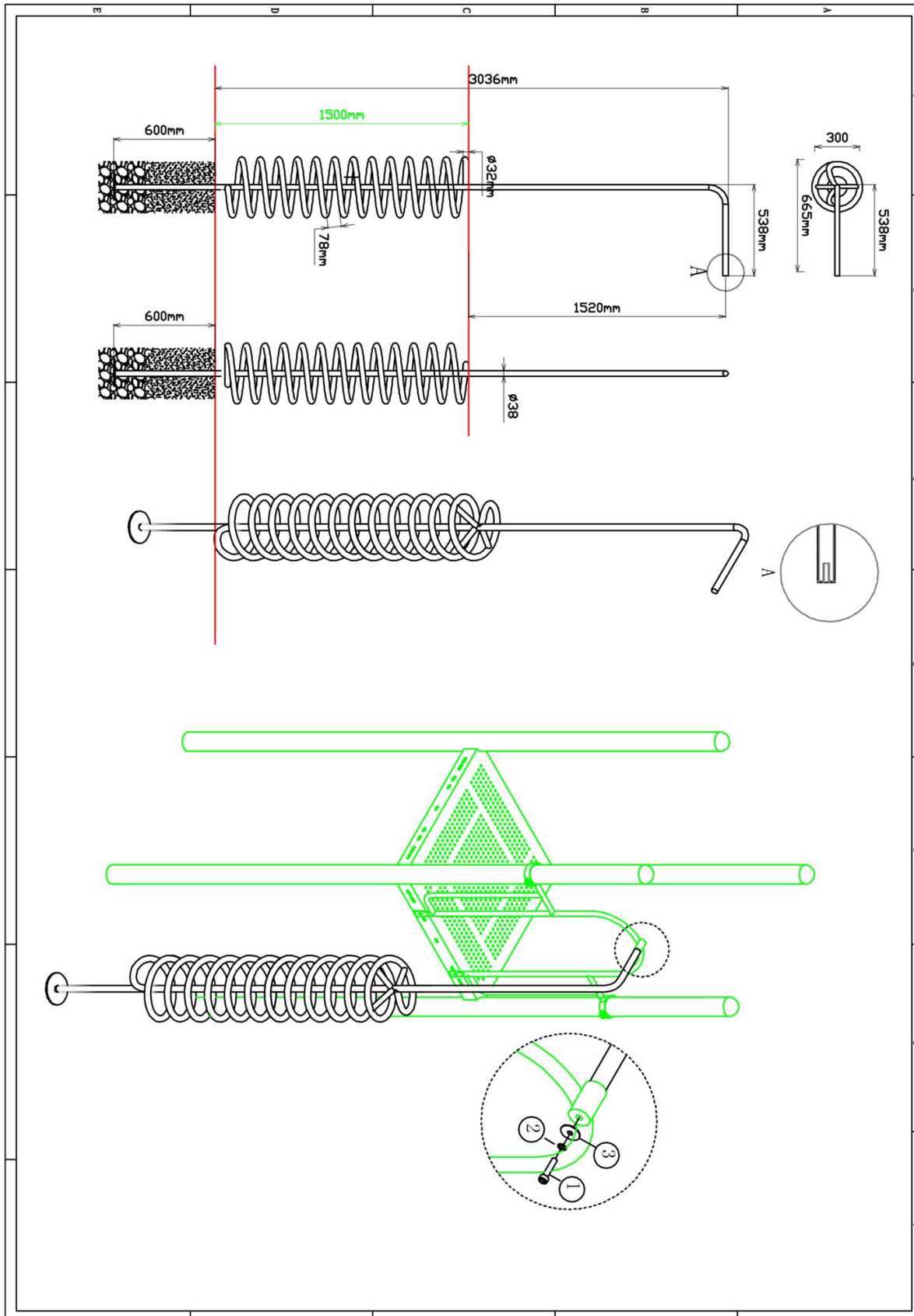

150cm Curly climber

STAP 1 van 1

Omschrijving: Bevestiging tussen Curly climber en hek

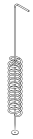
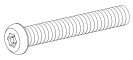
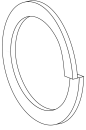
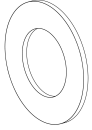
1 st. 150cm Curly climber	1 st. Torx M10X30	1 st. Veerring M10	1 st. Ring M10 (middel)
			

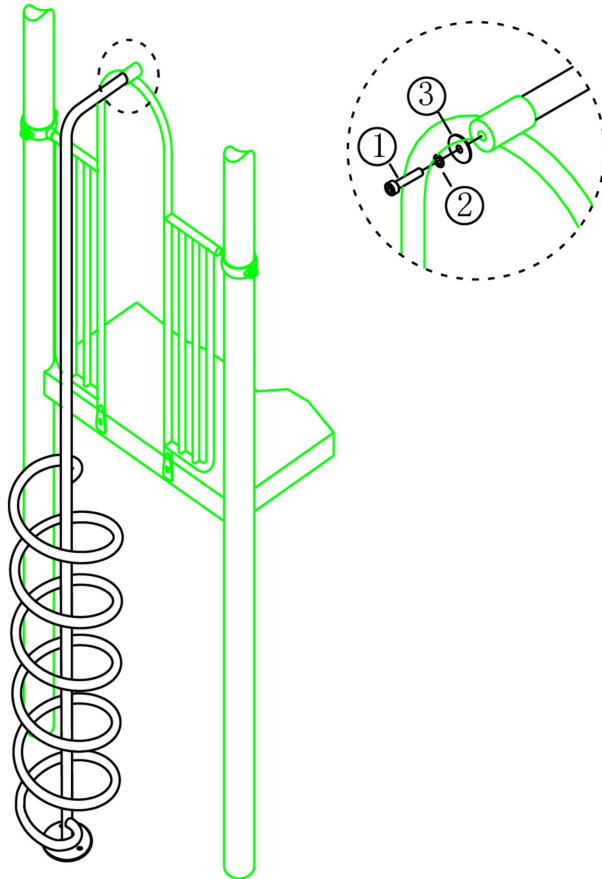

Bevestigings materiaal is per zakje verpakt en bovenstaande afbeelding zit in het zakje

Hekje tbv glijstang

STAP 1 van 1

Omschrijving: Bevestiging van het hek tussen de vloer/staander

1 st. Hekje tbv glijstang	2 st. Small clamp + ring	2 st. Afdekdop M10	2 st. Kruiskop M6X65
4 st. Torx M8X20	4 st. Lock Moer M8	2 st. Lock Moer M6	2 st. Bout M10X25
4 st. Ring M10 (middel)	2 st. Hoekje	2 st. Lock Moer M10	

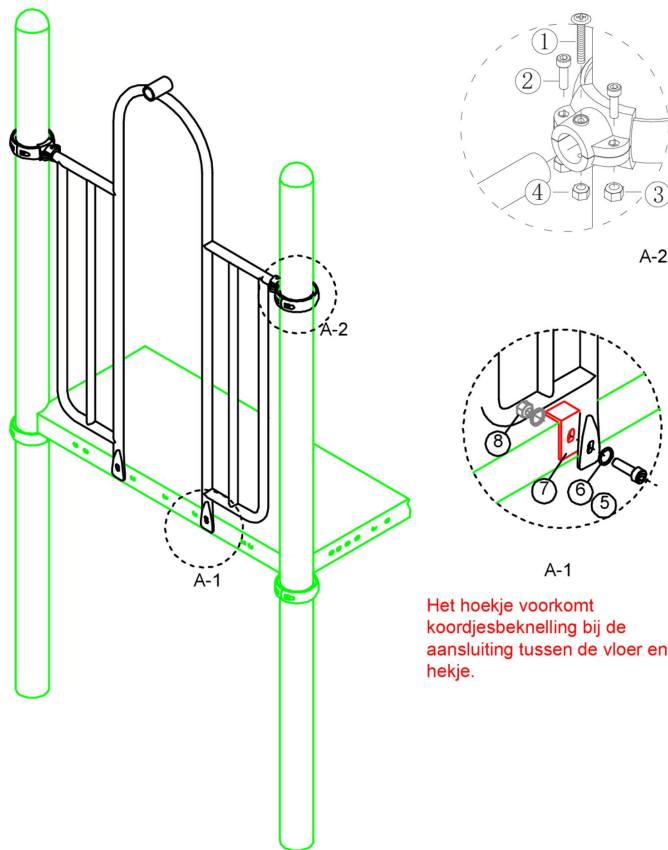

Het hoekje voorkomt koordjesbeknelling bij de aansluiting tussen de vloer en het hekje.

Bevestigings materiaal is per zakje verpakt en bovenstaande afbeelding zit in het zakje

150cm Glijstang

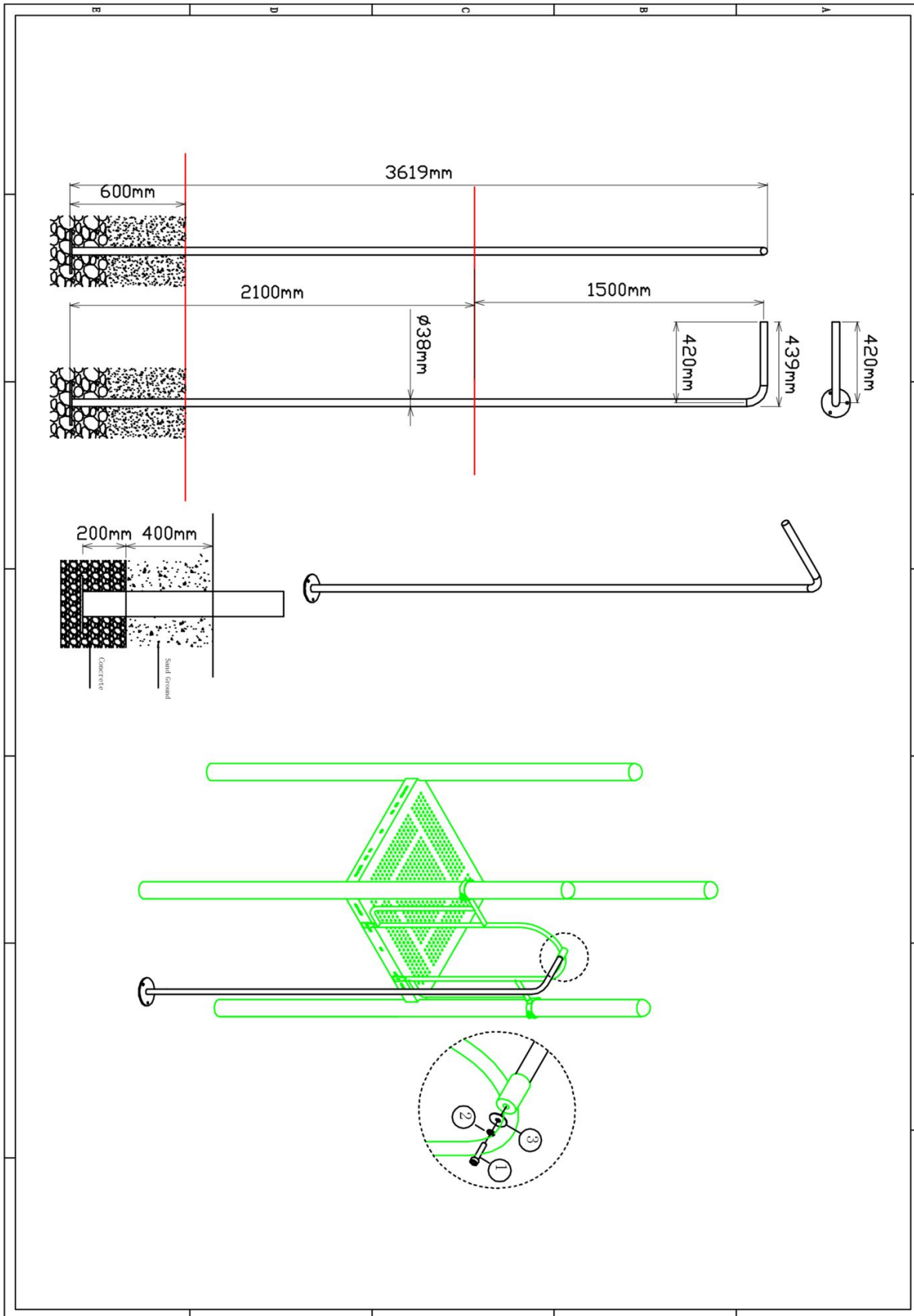

Hoofdafmetingen: 362x42cm



150cm Glijstang

STAP 1 van 1

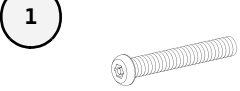
Omschrijving: Bevestiging tussen de glijstang en het hek

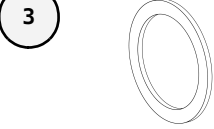
1 st. 150cm Glijstang	1 st. Torx M10X30	1 st. Veerring M10	1 st. Ring M10 (groot)
			

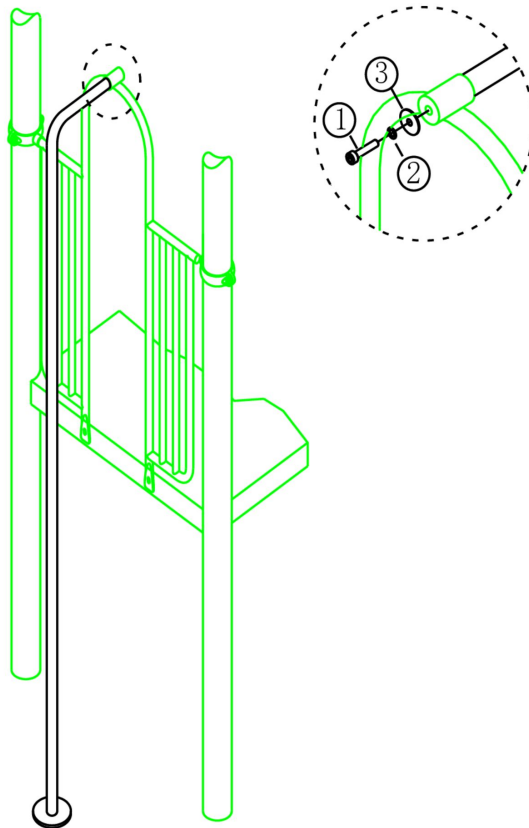







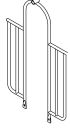

Bevestigings materiaal is per zakje verpakt en bovenstaande afbeelding zit in het zakje

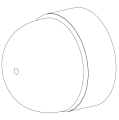
Hekje tbv: B, Pod en Curly Climber

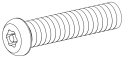
STAP 1 van 1

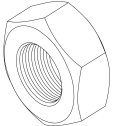
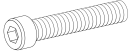
Omschrijving: Bevestiging van het hek tussen de vloer/staander

1 st. Hekje tbv: B, Pod en Curly Climber	2 st. Small clamp + ring	2 st. Afdekdop M10	2 st. Kruiskop M6X65
			① 
4 st. Torx M8X20	4 st. Lock Moer M8	2 st. Lock Moer M6	2 st. Bout M10X25
② 	③ 	④ 	⑤ 
4 st. Ring M10 (middel)	2 st. Lock Moer M10		
⑥ 	⑦ 		

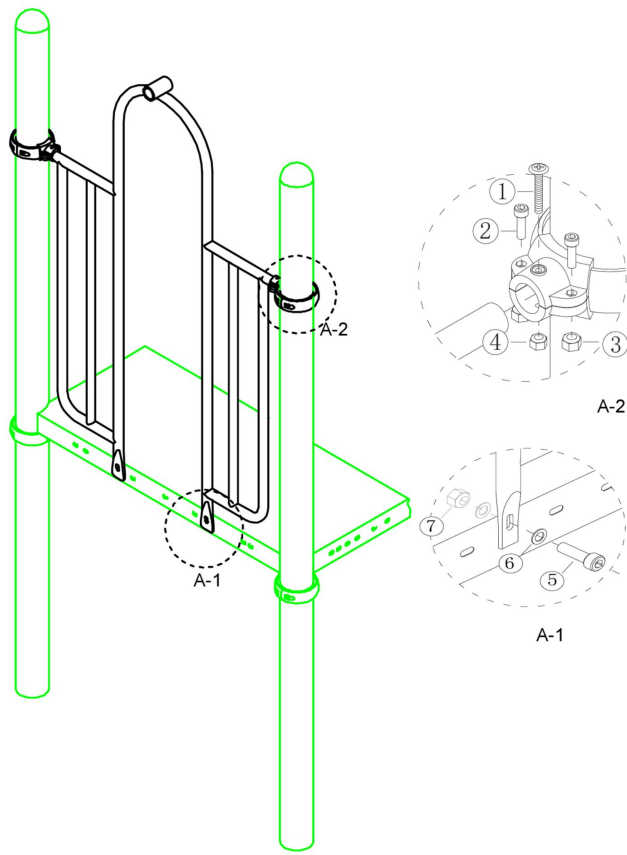

Bevestigings materiaal is per zakje verpakt en bovenstaande afbeelding zit in het zakje

150cm Pod climber

Hoofdafmetingen: 362x71cm

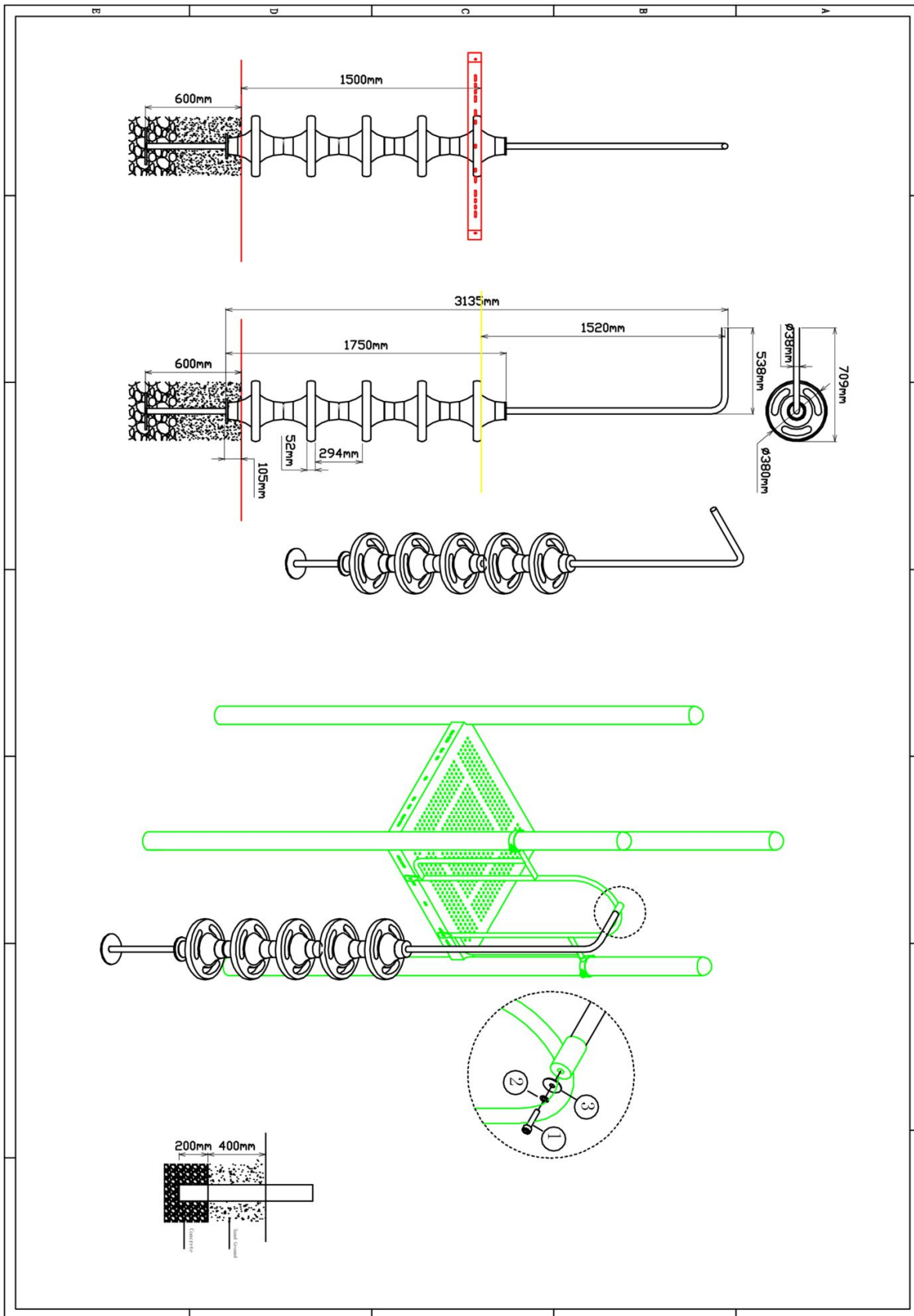

150cm Pod climber

STAP 1 van 1

Omschrijving: Bevestiging tussen hek en pod climber

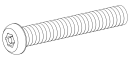
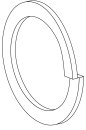
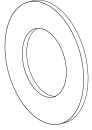
1 st. 150cm Pod climber	1 st. Torx M10X30	1 st. Veerring M10	1 st. Ring M10 (middel)
			

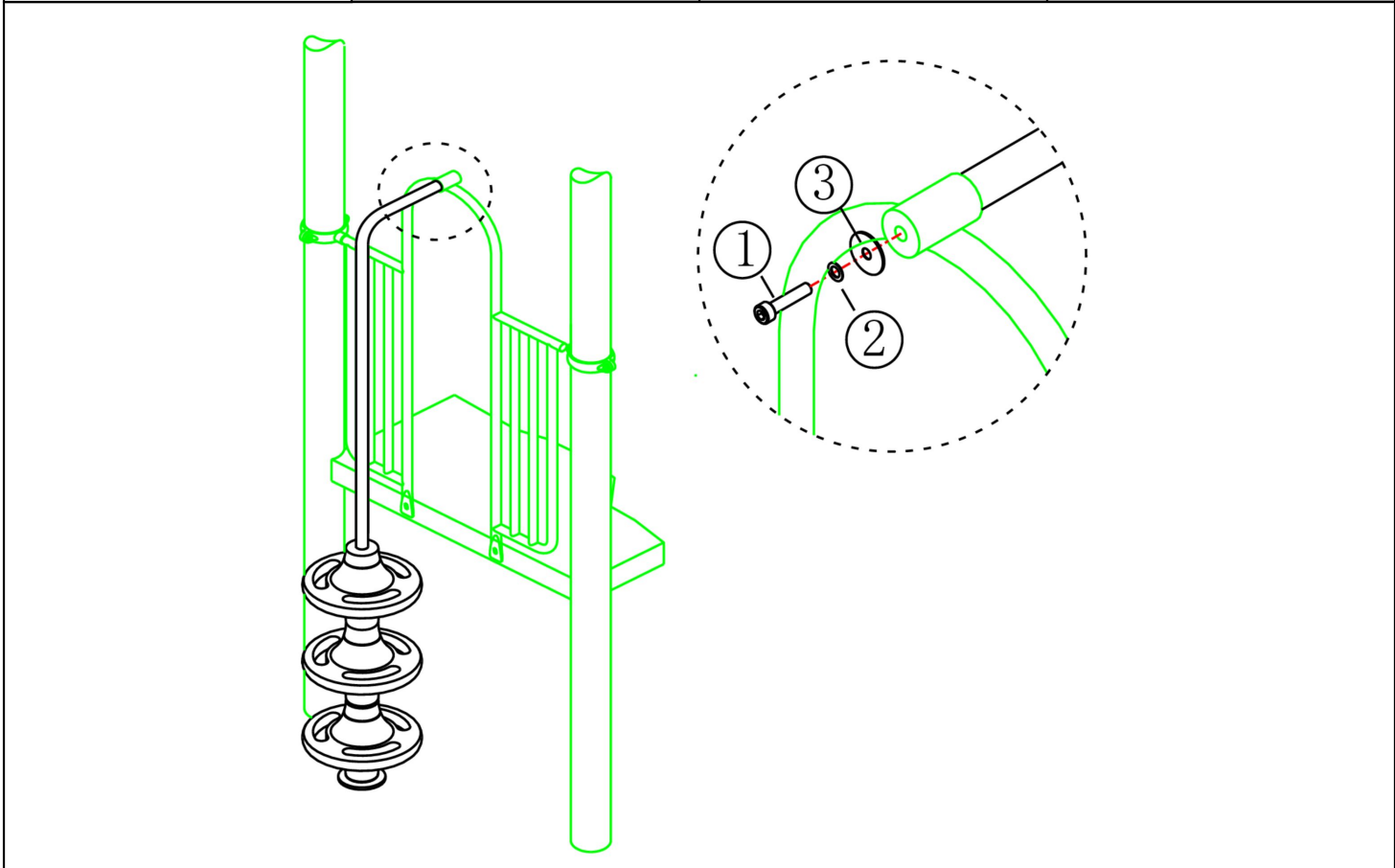

Bevestigings materiaal is per zakje verpakt en bovenstaande afbeelding zit in het zakje

Glijbaanpaneel HPL

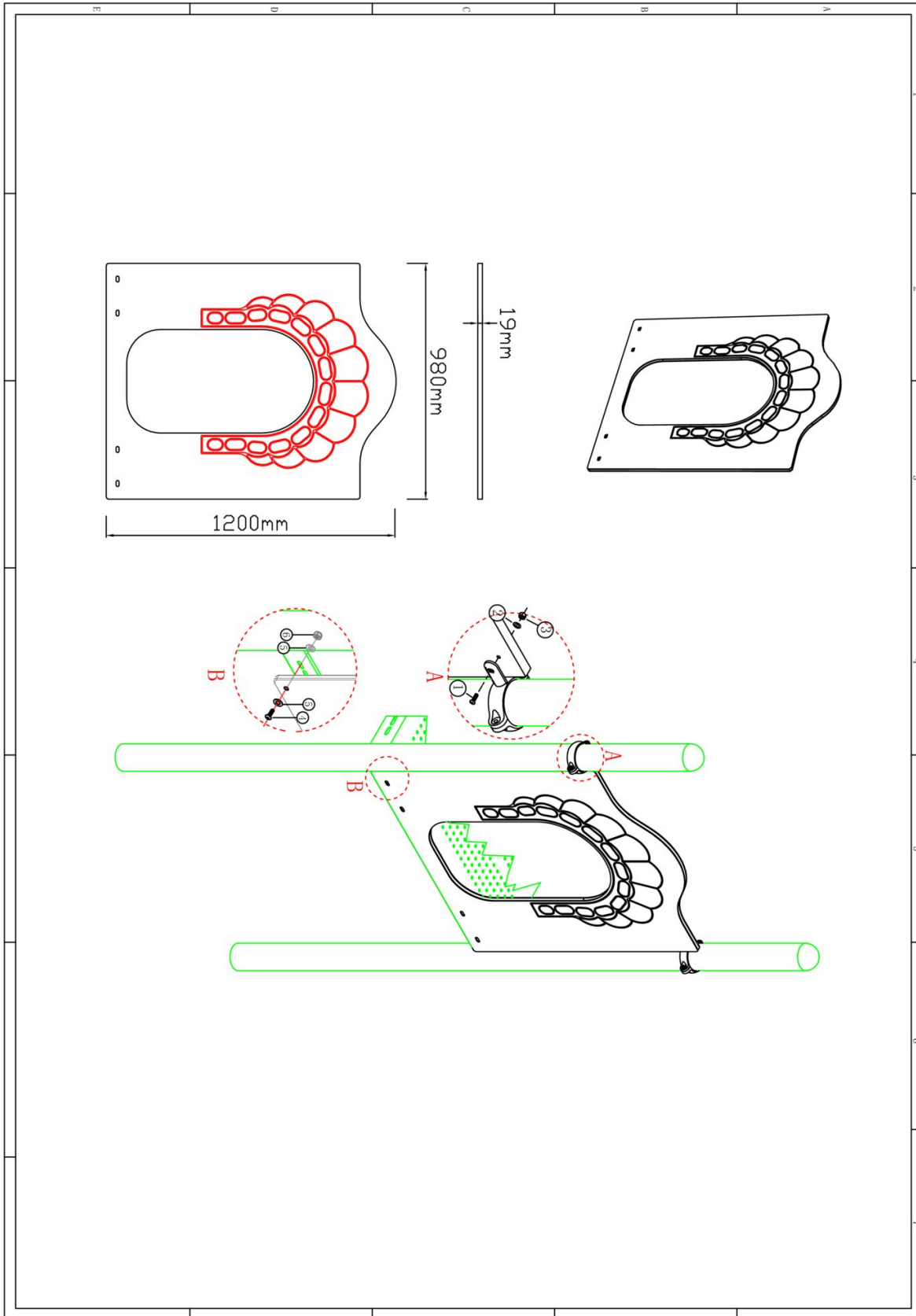

Hoofdafmetingen: 120x98x2 cm



Glijbaanpaneel HPL

STAP 1 van 1

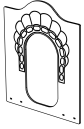
Omschrijving: Bevestiging tussen het glijbaanpaneel en de vloer / standers

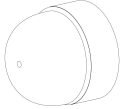
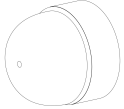
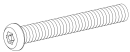
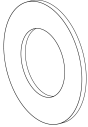
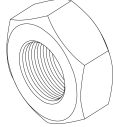
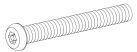
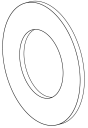
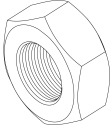
1 st. Glijbaanpaneel HPL	2 st. PE-Klem	2 st. Afdekdop M8	2 st. Afdekdop M10
			
2 st. Torx M8X35	2 st. Ring M8 (middel)	2 st. Lock Moer M8	2 st. Torx M10X35
1 	2 	3 	4 
4 st. Ring M10 (middel)	2 st. Lock Moer M10		
5 	6 		

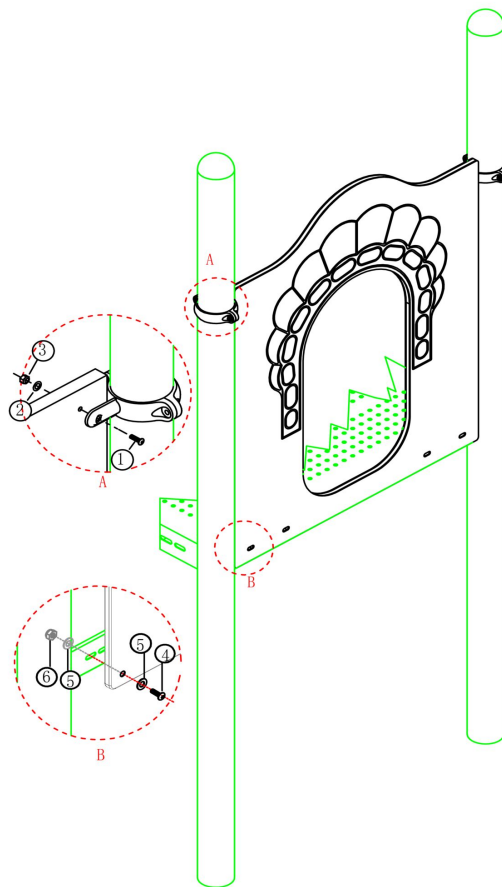

Bevestigings materiaal is per zakje verpakt en bovenstaande afbeelding zit in het zakje

150cm glijbaan recht



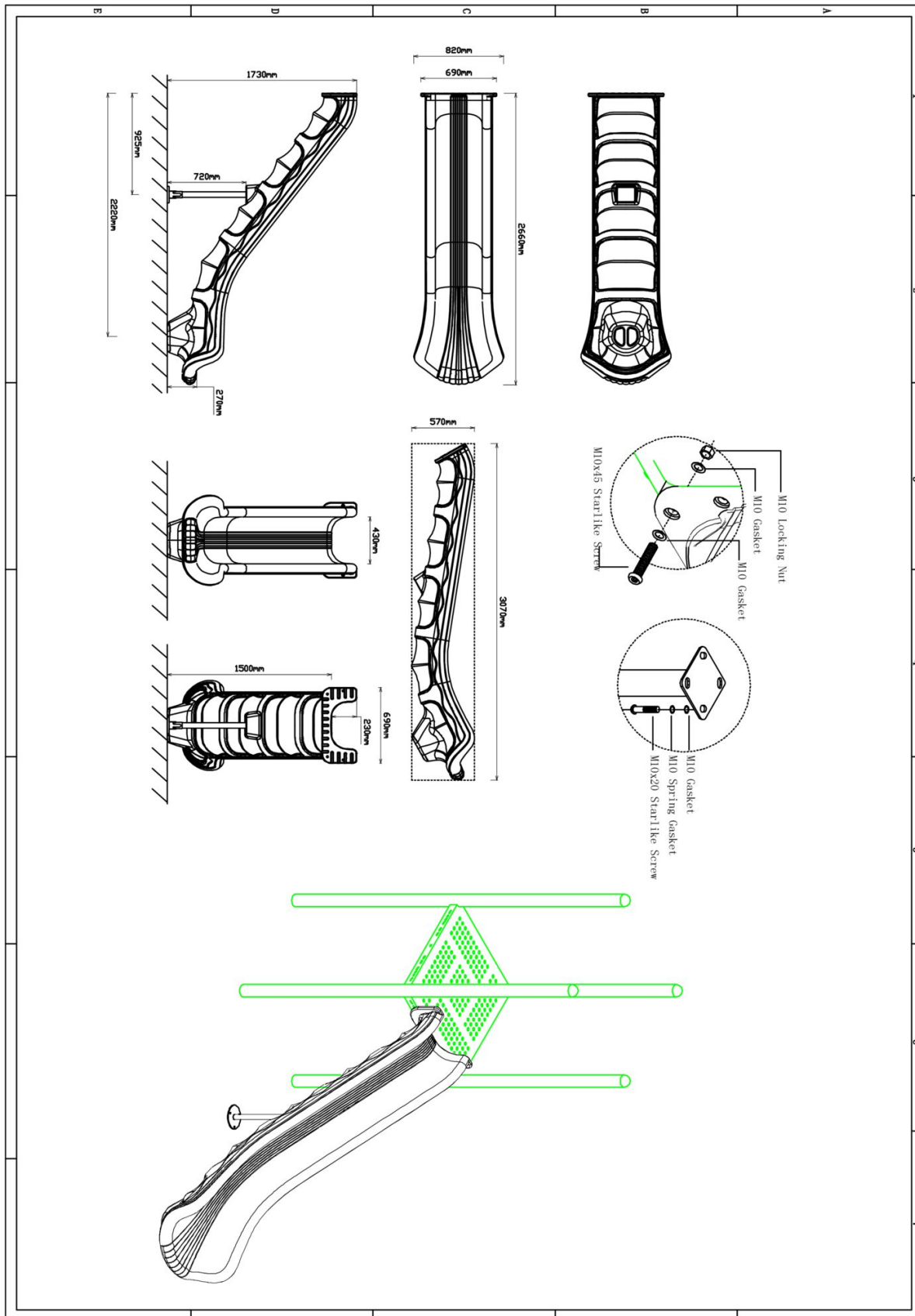



Hoofdafmetingen: 307x82x57cm

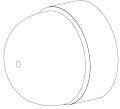

150cm glijbaan recht

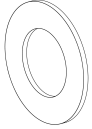
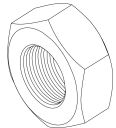
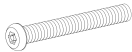
STAP 1 van 2

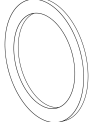
Omschrijving: Glijbaan aan de vloer en het paneel bevestigen

1 st. 150cm glijbaan recht	2 st. Afdekdop M10	2 st. Torx M10X45	4 st. Ring M10 (middel)
			
2 st. Lock Moer M10	2 st. Torx M8X35	2 st. Ring M8 (klein)	2 st. Ring M12 (groot)
			
2 st. Torx Spiraalbout M12			
			

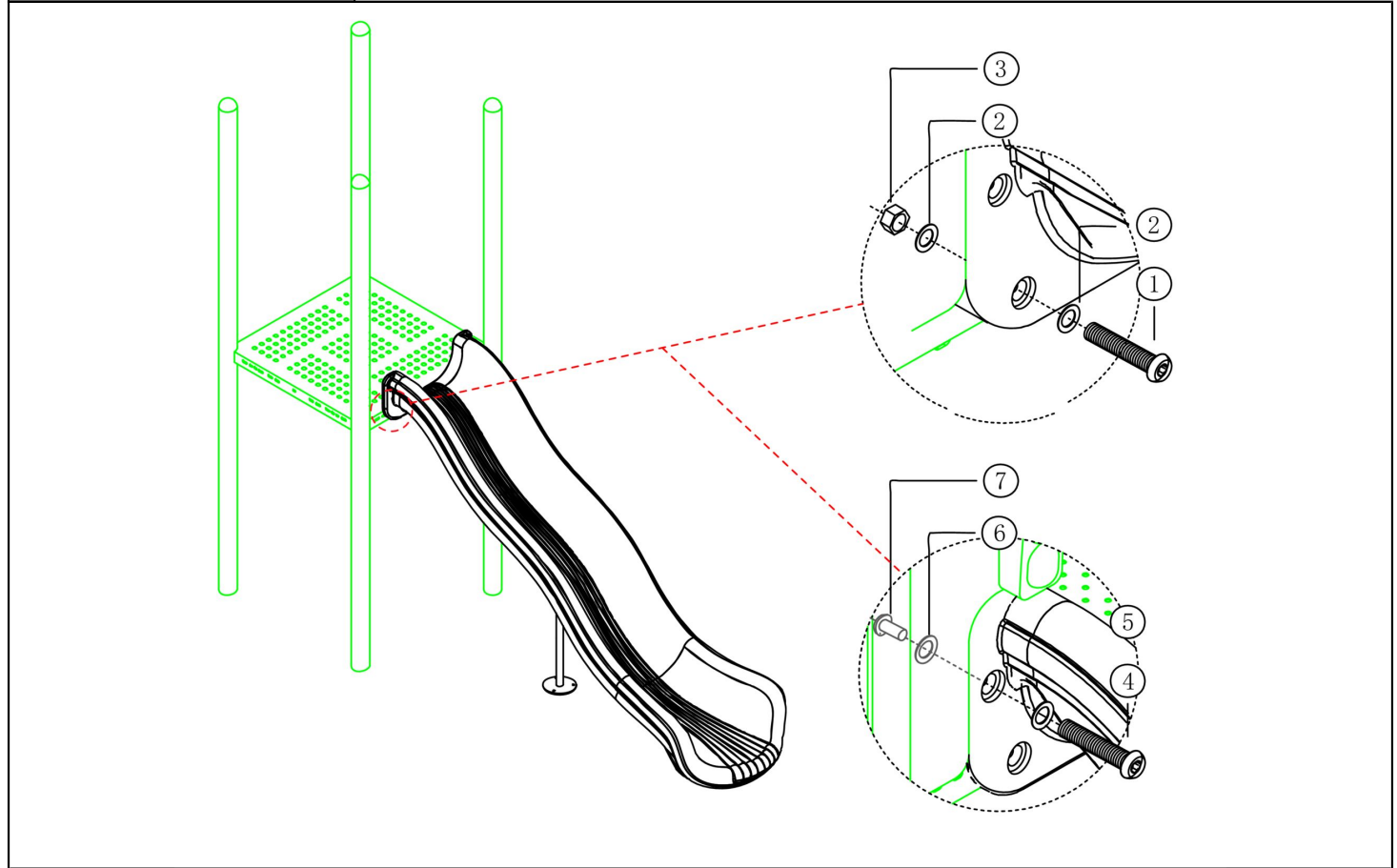

Bevestigings materiaal is per zakje verpakt en bovenstaande afbeelding zit in het zakje

150cm glijbaan recht

STAP 2 van 2

Omschrijving: Voorkom vinger- en koordjesbeknelling bij de glijbaanaansluiting. Zorg ervoor dat er geen kieren en naden zitten tussen de vloer/glijbaanpaneel en de glijbaan. Oplossen door de naden af te dichten met blanke kit die meegeleverd is.

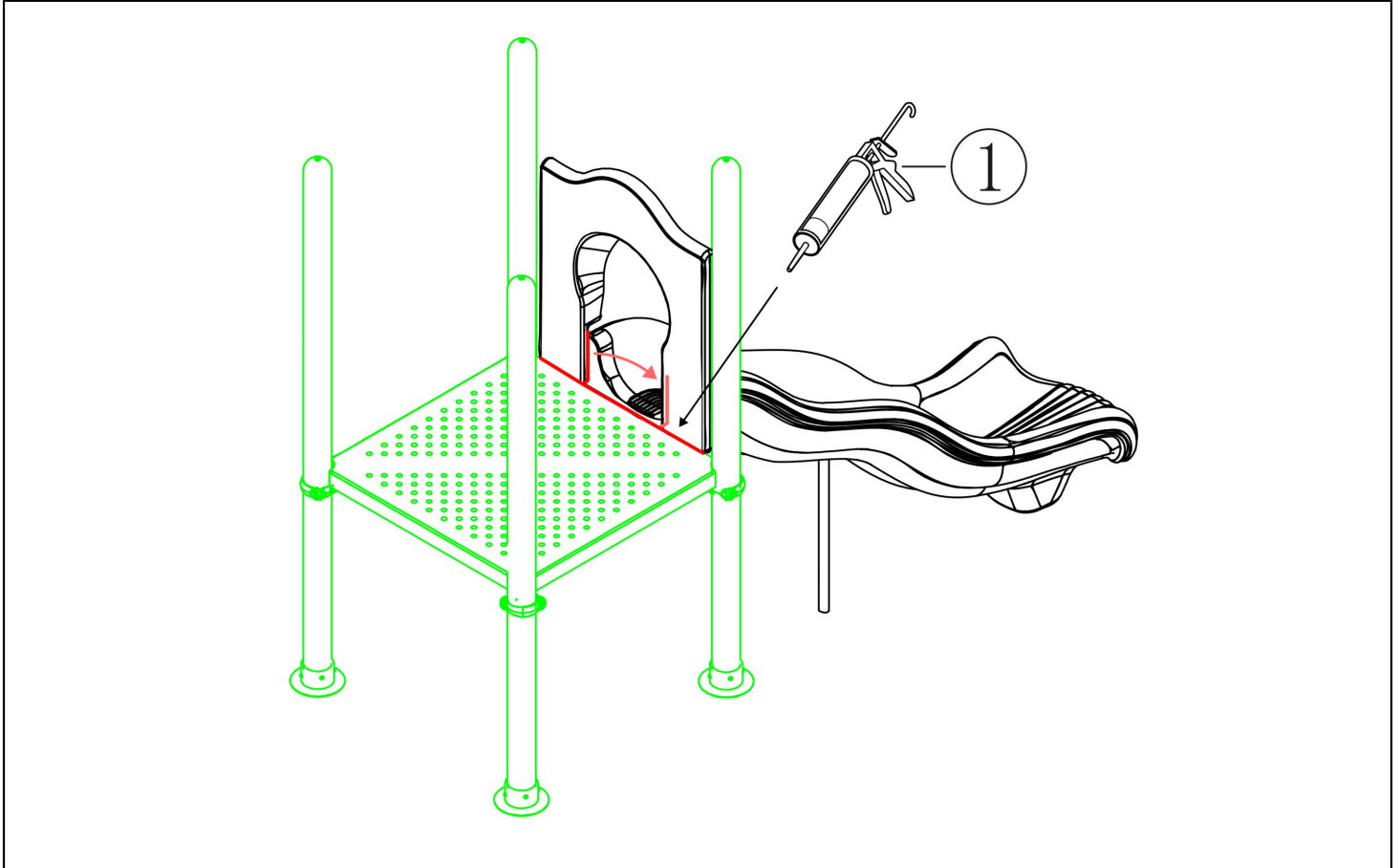

Bevestigings materiaal is per zakje verpakt en bovenstaande afbeelding zit in het zakje

Glijbaanvoet midden 150cm

Hoofdafmetingen: 132x16x12cm

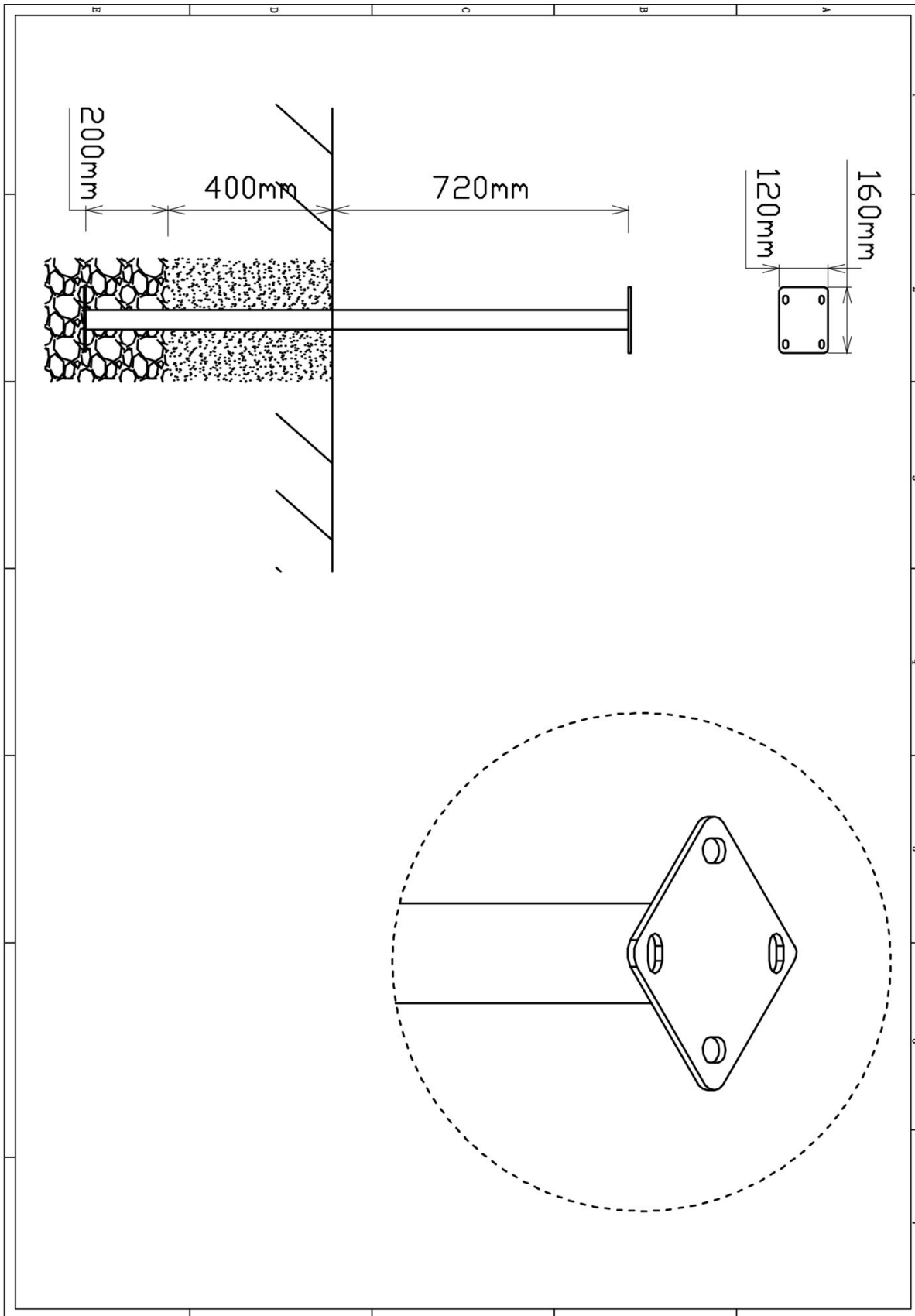

Glijbaanvoet midden 150cm

STAP 1 van 1

Omschrijving: Bevestiging van de voet onder de glijbaan

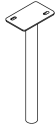
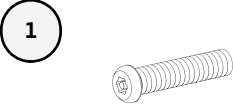
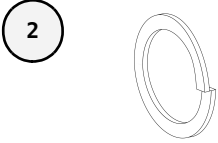
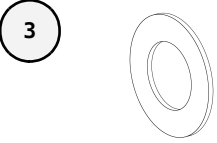
1 st. Glijbaanvoet midden 150cm	2 st. Torx M8X20	2 st. Veerring M8	2 st. Ring M8 (middel)
			

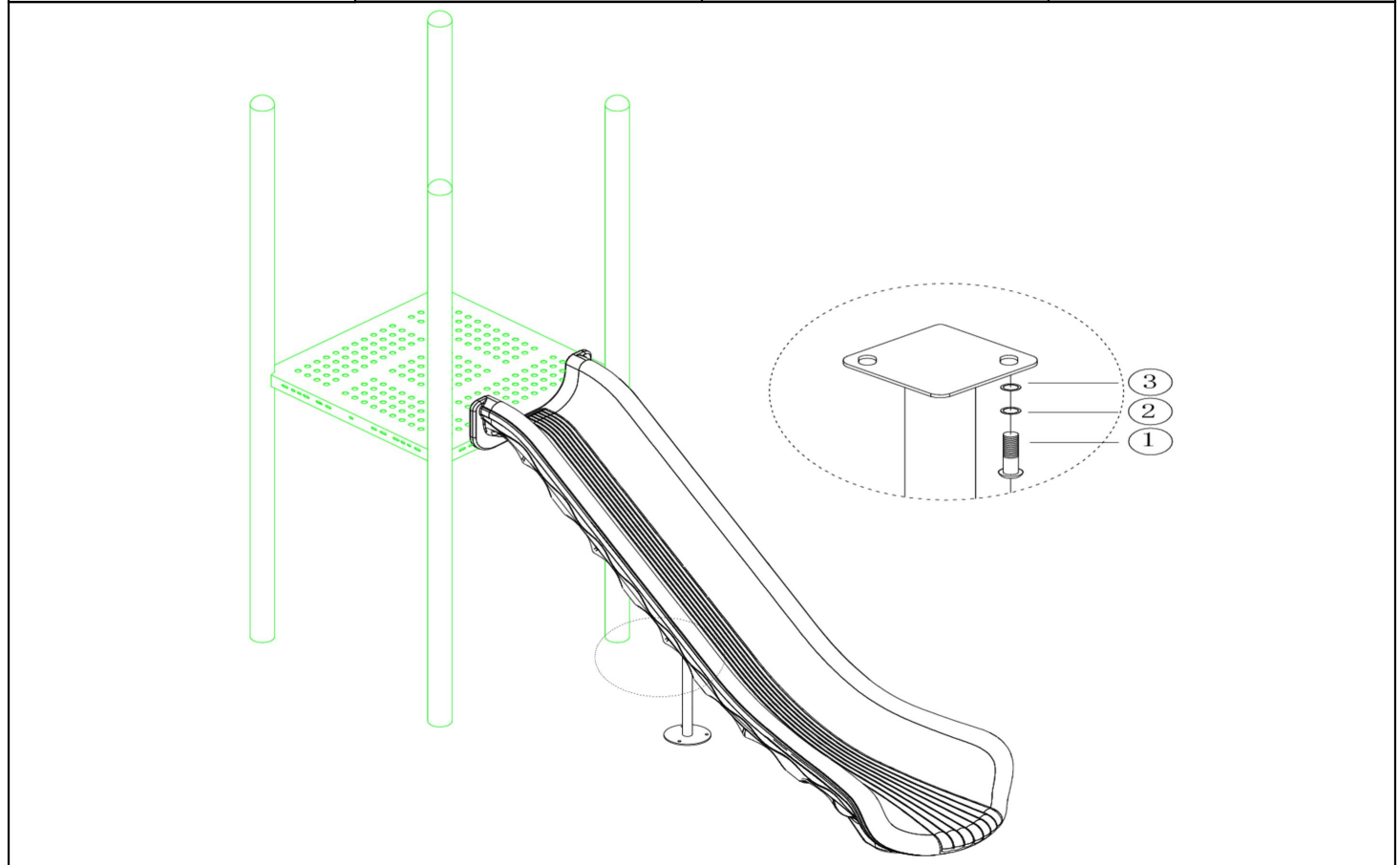

Bevestigings materiaal is per zakje verpakt en bovenstaande afbeelding zit in het zakje

Glijbaanvoet voorkant

Hoofdafmetingen: 30x15cm

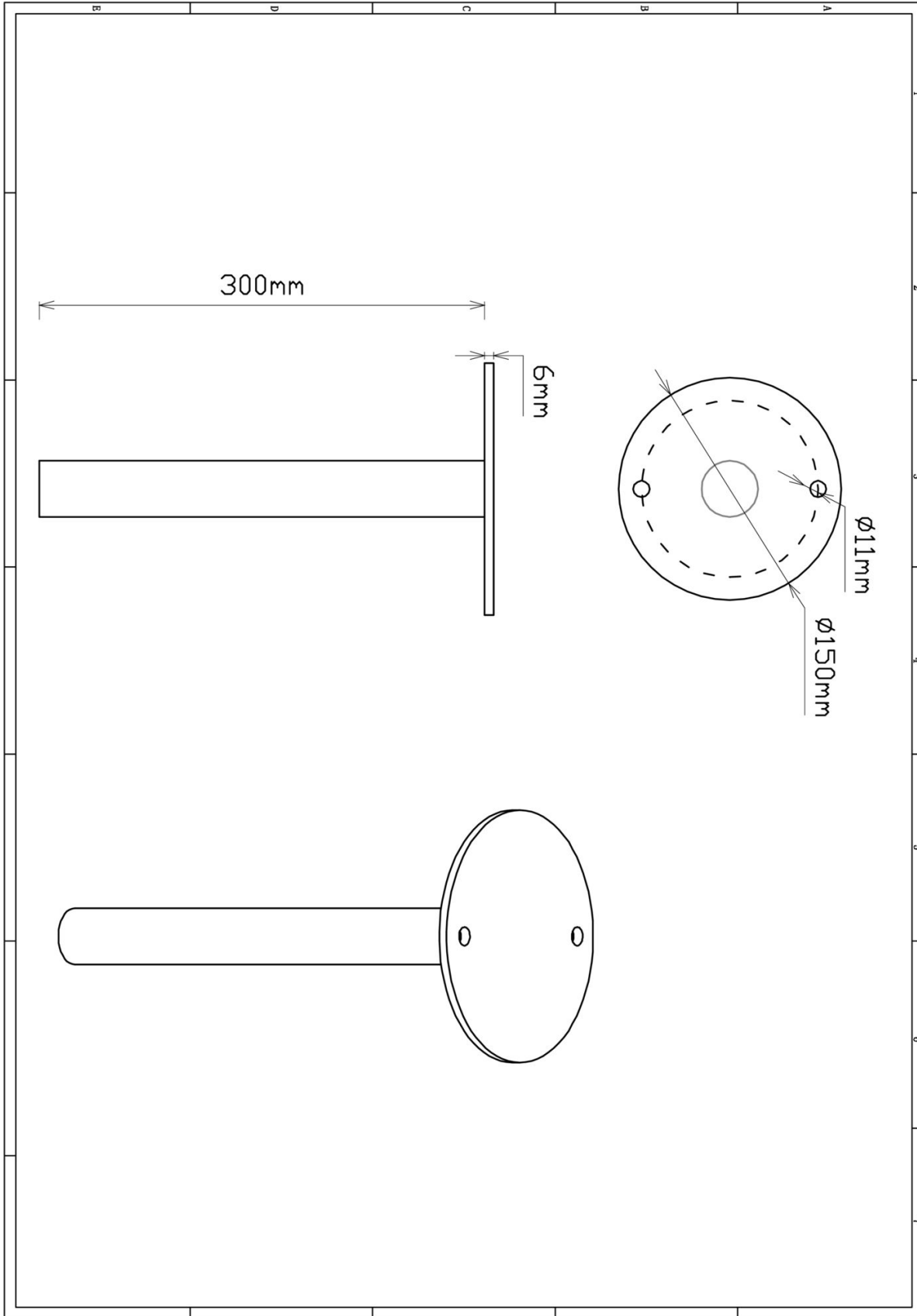

Glijbaanvoet voorkant

STAP 1 van 1

Omschrijving: Bevestiging van de voet onder de glijbaan

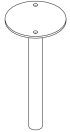
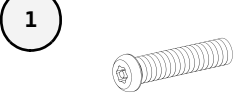
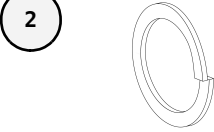
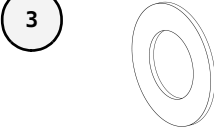
1 st. Glijbaanvoet voorkant	2 st. Torx M8X20	2 st. Veerring M8	2 st. Ring M8 (middel)
			

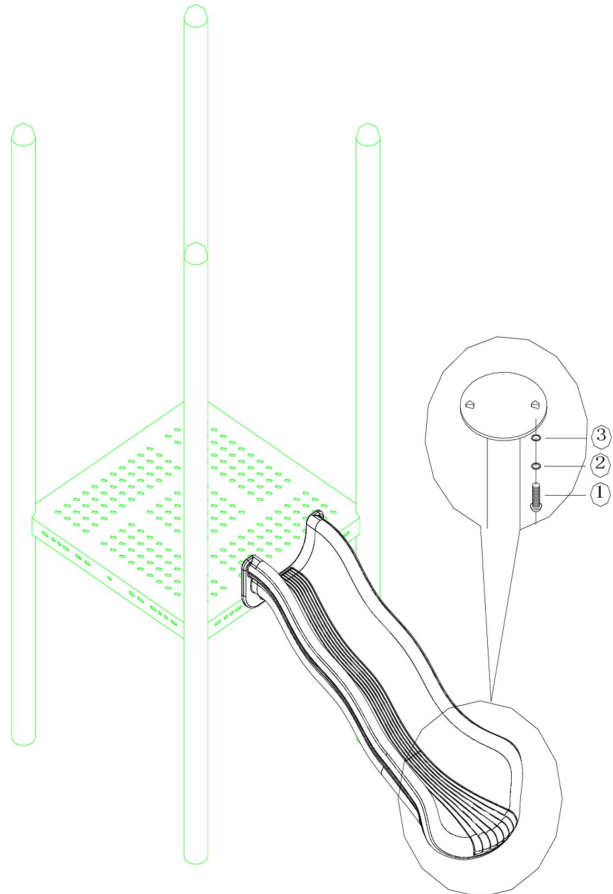

Bevestigings materiaal is per zakje verpakt en bovenstaande afbeelding zit in het zakje

Bankje 2.0

Hoofdafmetingen: 116x22x4cm

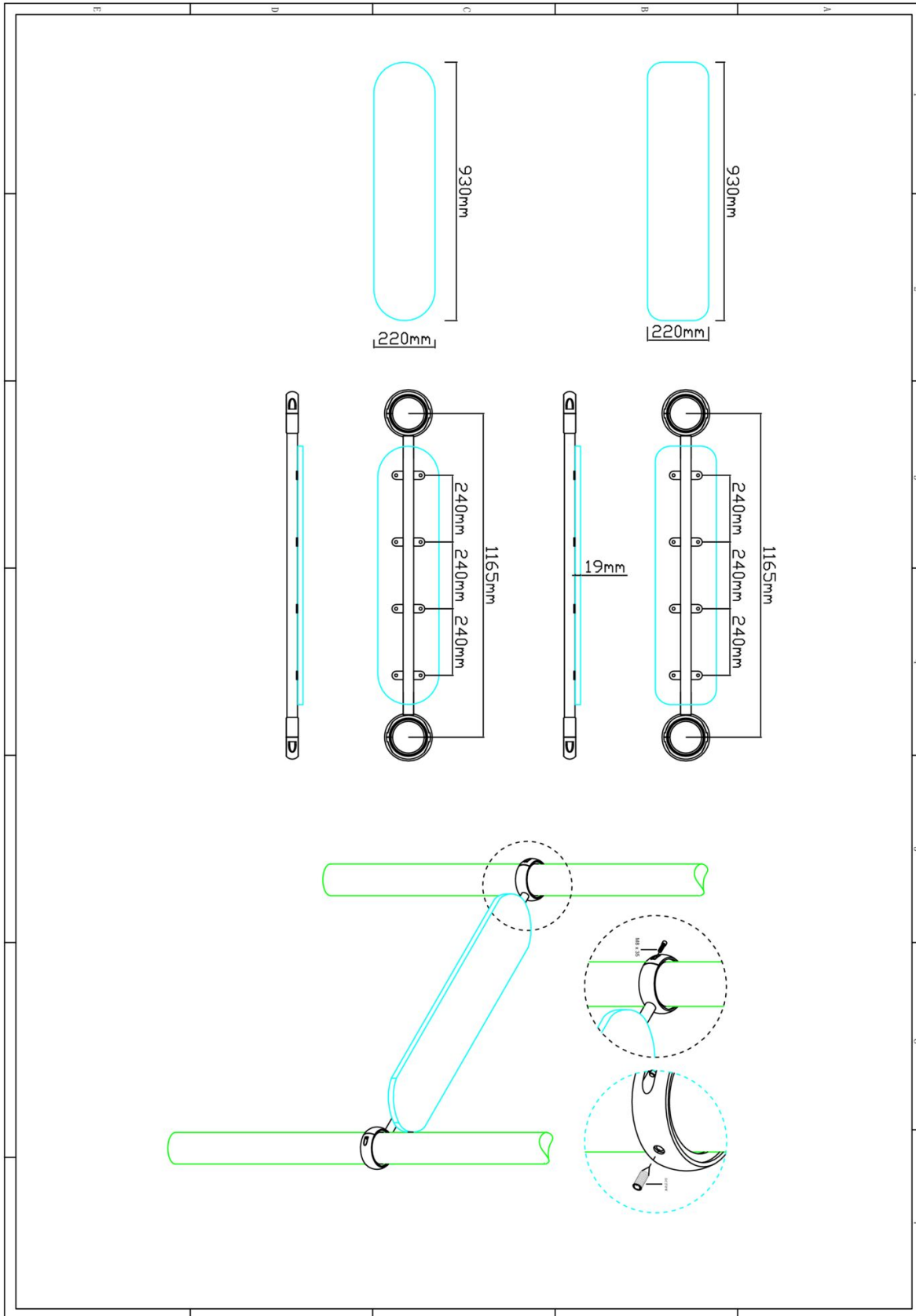

Bankje 2.0

STAP 1 van 1

Omschrijving: Bevestiging tussen de standers en de bank

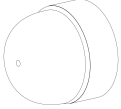
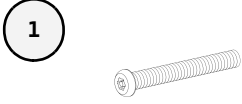
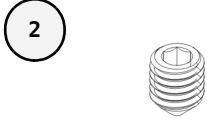
1 st. Bankje 2.0	8 st. Afdekdop M8	4 st. Torx M8X35	2 st. Inbus stelschroef M10x20
			

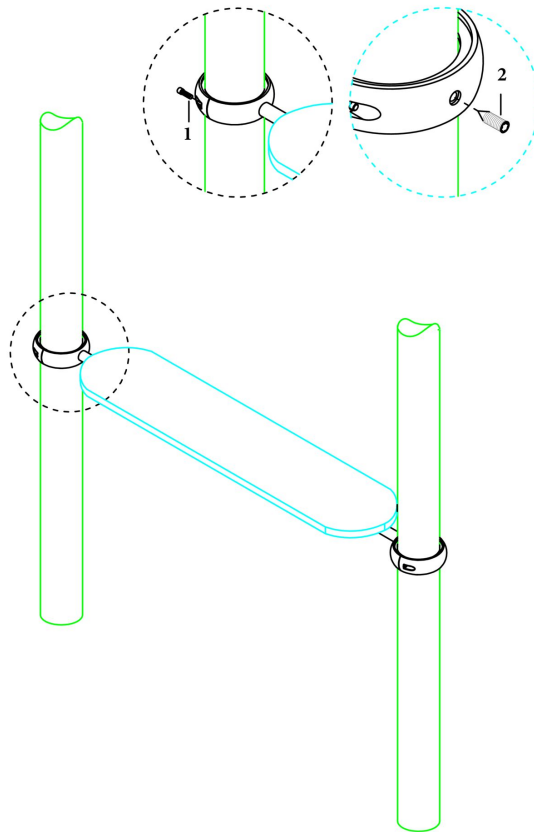

Bevestigings materiaal is per zakje verpakt en bovenstaande afbeelding zit in het zakje